

Light takes a
new direction:
Your direction



2019/20

EGLO CONNECT

CONTENTS

INHALT
CONTENU

KNOW HOW

INFORMATION
SAVOIR-FAIRE

P. 002 - 007

EASY, SMART & SAFE	P. 002 - 003
GROWS & LEARNS	P. 004 - 005
FUNCTION & CONTROL	P. 006 - 007

INDOOR LUMINAIRES

INNENLEUCHTEN
LUMINAIRES INTÉRIEURS

P. 008 - 045

BATHROOM LUMINAIRES

BADLEUCHTEN
LUMINAIRES DE BAIN

P. 046 - 049

OUTDOOR LUMINAIRES

AUSSENLEUCHTEN
LUMINAIRES EXTÉRIEURS

P. 50 - 069

ILLUMINANTS

LEUCHTMITTEL
AMPOULES

P. 070 - 073

LEGEND & REGISTER

ERKLÄRUNG & REGISTER
LÉGENDE & REGISTRE

P. 074 - 080



1



Luminaire / Bulb
Leuchte / Leuchtmittel
Luminaire / Ampoules

2



Remote Control / App
Fernbedienung / App
Télécommande / App

3



LET'S GO!!!

EASY, SMART & SAFE

EINFACH, INTELLIGENT & SICHER
SIMPLE, INTELLIGENT ET SÛR

If you're looking for easy installation and uncomplicated devices, EGLO connect is the right place for you.

Suchst du leichte Installationen und unkomplizierte Geräte - dann bist du bei EGLO connect genau richtig.

Des installations aisées et des appareils simples – EGLO connect est le bon dispositif pour toi.

Starting is made quick and easy, you only need two components:

Der Einstieg ist schnell und einfach, du benötigst nur zwei Komponenten:

Les premiers pas sont simples et rapides, tu as besoin de deux objets :

- › An EGLO connect luminaire / illuminant
- › An EGLO connect remote control or the free AwoX Smart control App

- › Eine EGLO connect Leuchte / Leuchtmittel
- › Eine EGLO connect Fernbedienung oder die kostenlose AwoX Smart control App

- › Une lampe / ampoule EGLO connect
- › Une télécommande EGLO connect ou l'application gratuite AwoX Smart control

You'll be set to start immediately then!

Schon kann's losgehen!

Prêt à te lancer!

The system's basic advantages are:

Die grundlegenden Vorteile des Systems sind:

Les avantages primordiaux du système sont:



Simple installation

EGLO connect products use Bluetooth technology and do not need any elaborate installations.

Einfache Installation

EGLO connect Produkte verwenden die Bluetooth Technologie und benötigen keine aufwändigen Installationen.

Une installation simple

Les produits EGLO connect emploient la technologie Bluetooth et ne nécessitent pas d'installations complexes.



Smart technology

The EGLO connect items communicate with each other to form a smart, expandable network (MESH technology).

Smarte Technologie

Die EGLO connect Artikel kommunizieren miteinander und bilden ein intelligentes, erweiterbares Netzwerk (MESH-Technologie).

Une technologie intelligente

Les articles EGLO connect communiquent les uns avec les autres et forment un réseau intelligent et extensible (technologie MESH).



Protected network

All EGLO connect products in your home form a closed network and are secured against third-party access.

Geschütztes Netzwerk

Alle EGLO connect Produkte in deinem Zuhause bilden ein geschlossenes Netzwerk und sind vor fremdem Zugriff gesichert.

Un réseau protégé

Tous les produits EGLO connect dans ton foyer forment un réseau fermé et sont ainsi protégés des accès étrangers.

Q BASIC USER

Kein Wlan / Internet notwendig.
Steuerbar mit Fernbedienung.

No WLAN / internet necessary.
Controllable via a remote control.

Pas de Wifi / Internet nécessaire.
Commandable par télécommande.



Q ADVANCED USER

Internetverbindung wird nur zur App Installation, Registrierung und für Updates benötigt.

Steuerbar mit Smartphone / Tablet (App) und Fernbedienung.

Einbindung eines batteriebetriebenen Sensors mit Day & Night Funktion und Bewegungserkennung möglich.

Internet connection only needed for the installation of the app, registration and updates.

Controllable via smartphone / tablet (app) and remote control.

Integration of a battery-operated sensor with Day & Night function and motion detection possible.

Connexion Internet requise uniquement pour l'installation de l'appli, l'enregistrement et les mises à jour.

Commandable avec Smartphone / Tablette (appli) et télécommande.

Intégration d'un capteur à batteries avec fonction « Jour et nuit » et détection de mouvement possible.



4

Q POWER USER

Du nutzt das volle Potential von EGLO connect.

Der PLUG PLUS ermöglicht es mithilfe von Alexa, Google Home und deinem Smartphone/Tablet das System von Zuhause oder unterwegs zu steuern.

You use the full potential of EGLO connect.

The PLUG PLUS allows Alexa, Google Home and your smartphone / tablet to control the system from home or on the road.

Vous utilisez tout le potentiel d'EGLO connect.

Le connecteur PLUS permet à Alexa, Google Home et votre Smartphone / Tablette, de commander le système connect de chez vous ou à distance.



GROWS & LEARNS

WÄCHST & LERNT
APPRENDRE ET ÉVOLUER

EGLO connect grows to match your needs:

BASIC USER:

Use the EGLO connect remote control together with the EGLO connect lamps / luminaires to adjust brightness, colours and mood. These functions are practical, easy to handle and will meet your daily needs.

ADVANCED USER:

Use the App and expand your options: Combine living areas into groups to control lighting and other devices practically and quickly. Add to the experience of a movie night with the matching light scenario.

POWER USER:

Use the full potential of EGLO connect and the PLUG PLUS: Away from-Home control by integration in your WiFi, control by speech commands via Amazon Echo and Google Home, Day & Night function including motion detection and much more – the future of lighting in your home.

EGLO connect wächst mit deinen Bedürfnissen:

BASIC USER:

Du nutzt die EGLO connect Fernbedienung zusammen mit den EGLO connect Leuchtmitteln / Leuchten. Damit stellst du Helligkeit, Farbe und Stimmung ein. Diese Funktionen sind praktisch, einfach zu handhaben und genügen deinen täglichen Bedürfnissen.

ADVANCED USER:

Du nutzt die App und erweiterst deinen Spielraum: Fasse Wohnbereiche zu Gruppen zusammen, um Licht und andere Geräte praktisch und schnell ansteuern zu können. Verstärke das Erlebnis eines Filmabends mit dem passenden Lichtszenario.

POWER USER:

Du nutzt das volle Potential von EGLO connect und dem PLUG PLUS. Away from-Home control durch Intergration in dein W-Lan, Steuerung per Sprachbefehl mit Hilfe von Amazon Echo und Google Home, Day & Night Funktion inklusive Bewegungserkennung und vieles mehr – Lichtzukunft in deinem Heim.

EGLO connect évolue avec tes besoins:

UTILISATEUR DE BASE:

Tu utilises la télécommande EGLO connect conjointement avec les ampoules/luminaires EGLO connect. Tu régles ainsi la luminosité, la couleur et l'ambiance. Ces fonctions sont pratiques, faciles à manier et suffisent à tes besoins au quotidien.

UTILISATEUR AVANCÉ:

Tu utilises l'application et accrois ta marge de manoeuvre : tu rassembles des zones d'habitat en des groupes afin de pouvoir commander la lumière et les autres appareils de manière rapide et pratique. Renforces l'ambiance d'une soirée film par la scénérie lumineuse correspondante.

UTILISATEUR PUISSANT:

Tu utilises l'ensemble du potentiel d'EGLO connect et PLUG PLUS. Un contrôle hors de chez toi par l'intégration dans ton Wi-Fi, un pilotage par commande vocale avec Amazon Echo et Google Home, une fonction jour & nuit avec détection de mouvements et bien d'autres choses - l'avenir de l'éclairage dans ta maison.



FUNCTION & CONTROL

FUNKTION & BEDIENUNG FONCTION ET COMMANDE



Connect Sensor
Connect Sensor
Capteur Connect



Remote control
Fernbedienung
Télécommande



App control
App
App



CONNECT
PLUG



CONNECT
PLUG PLUS



**Functions
Funktionen
Fonctions**

Basic functions / Grundfunktionen / Fonctions de base

Activation / deactivation Ein- / Ausschalten Allumer / éteindre		•	•	•	•
Motion sensor Bewegungssensor Capteur de mouvements	•				
Light colour regulation Lichtfarben regulieren Réguler les teintes lumineuses		16,7 Mio.	16,7 Mio.		16,7 Mio.
Smooth dimming* Stufenloses Dimmen* Graduation continue*		•	•		
Voice control Sprachsteuerung Commande par la voix					•

Comfort functions / Komfortfunktionen / Fonctions confort

Pre-set scenarios Voreingestellte Szenarien Scéneries prédéfinies			•		
Saving favourites Favoriten speichern Sauvegarder les favoris		2	4		
Grouping lamps Leuchten gruppieren Regroupement des luminaires			•		
Programming function (on / off) Programmierfunktion (Ein / Aus) Fonction de programmation (marche / arrêt)			•	•	•
Dawn simulation Dämmerungssimulation Simulation de crépuscule			•		
Timer function Timer-Funktion Fonction de minuterie			•	•	•
Day & night function Tag & Nacht-Funktion Fonction jour & nuit	•				
Night light Nachtlicht Veilleuse de nuit			•		
Names & pictures for luminaires Namen & Bilder für Leuchten Noms et photos pour les luminaires			•		
Disco function Diskofunktion Fonction disco			•		
BLE Smart Meter function BLE Smart Meter Funktion BLE Fonction smart meter				•	•

















































* for EGLO connect luminaires / bulbs only - nur für EGLO connect Leuchten / Leuchtmittel - seulement pour luminaires / ampoules EGLO connect

EGLO CONNECT INDOOR



OVERVIEW

EGLO CONNECT INDOOR

 CONNECT REMOTE 10	 CONNECT PLUG 11	 CONNECT PLUG PLUS 11	 TABRIZ-C 12	 TABRIZ-C 12	 FRAIOLI-C 14	 FRAIOLI-C 14	 FRAIOLI-C 14
 FRAIOLI-C 15	 FRAIOLI-C 15	 FRATTINA-C 16	 FRATTINA-C 16	 FRATTINA-C 16	 FRATTINA-C 17	 OPTICA-C 18	 RIODEVA-C 19
 RIODEVA-C 19	 COMBA-C 19	 MONEVA-C 20	 MONEVA-C 21	 HORNITOS-C 23	 CERIGNOLA-C 23	 VOLTAGO-C 24	 TOTARI-C 24
 TOTARI-C 24	 TOTARI-C 25	 GIRON-C 26	 COMPETA-C 26	 CAPASSO-C 26	 CAPASSO-C 27	 PALOMBARE-C 28	 PALOMBARE-C 28
 PALOMBARE-C 28	 PALOMBARE-C 29	 CORROPOLI-C 30	 CORROPOLI-C 30	 CORROPOLI-C 30	 CORROPOLI-C 31	 SARSINA-C 32	 SALOBRENA-C 34
 SALOBRENA-C 35	 SALOBRENA-C 35	 FUEVA-C 36	 FUEVA-C 36	 FUEVA-C 38	 FUEVA-C 38	 FUEVA-C 40	 FUEVA-C 41
 FUEVA-C 42	 FUEVA-C 43	 STRIP-C 44					



97476



32732

32732 CONNECT REMOTE

remote control; plastic, white
 Fernbedienung; Kunststoff, weiss
 télécommande; plastique, blanc

L 110, B 53, H 20



incl.
Wifi-Bridge



97936



97476

97936 CONNECT PLUG PLUS

plug; plastic, white
Stecker; Kunststoff, weiss
connecteur; plastique, blanc

L 62, H 115, A 39

97476 CONNECT PLUG

plug; plastic, white
Stecker; Kunststoff, weiss
connecteur; plastique, blanc

L 62, H 115, A 39

CONNECT PLUG PLUS & CONNECT PLUG

The intelligent connector that checks your consumption and turns all your devices into smart objects. Now you can control your home with the touch of a finger.

FEATURES CONNECT PLUG PLUS & CONNECT PLUG

- › **ON / OFF** - with AwoX Smart Control / remote control
- › **BLE Power Meter**
- › **Power rating** - 10A / max. 2300W / 230 V AC
- › **Control distance** - up to 15 m
- › **Connectivity** - Bluetooth® Smart Mesh
- › **Version** - GE (Shuko CEE 7/7)

ADDITIONAL FEATURES PLUG PLUS

Local and external control: Local control via Bluetooth® Mesh-Technology and Away-from-home-control via AwoX Cloudservice • **Voice Control:** Amazon Alexa supported / Google Home ready • **Connectivity:** Wi-Fi Bridge with Bluetooth® Mesh ecosystem.

Der kluge Stecker, der deinen Stromverbrauch misst. Verwandle alle deine Geräte in smarte Objekte. Jetzt kannst du dein ganzes Haus mit der Berührung eines Fingers bedienen.

FUNKTIONEN CONNECT PLUG PLUS & CONNECT PLUG

- › **ON / OFF** - mit AwoX Smart Control App / Fernbedienung
- › **BLE Energiemesser**
- › **Power rating** - 10A / max. 2300W / 230 V
- › **Bedienreichweite** - bis zu 15 m
- › **Connectivity** - Bluetooth® Smart Mesh
- › **Version** - GE (Shuko CEE 7/7)

ZUSÄTZLICHE FUNKTIONEN PLUG PLUS

Lokale Steuerung und externe Fernsteuerung: Lokale Steuerung mittels Bluetooth® Mesh-Technologie und Away-from-home-Steuerung mittels AwoX Cloudservice • **Sprachsteuerung:** Unterstützung von Amazon Alexa / Google Home ready • **Verbindung:** Wi-Fi Bridge mit Bluetooth® Mesh ecosystem.

La prise programmable qui mesure ta consommation d'électricité. Transforme tous tes appareils en objets connectés. Maintenant tu peux contrôler toute ta maison en un clic.

FUNCTIONS CONNECT PLUG PLUS & CONNECT PLUG

- › **MARCHE / ARRÊT (ON / OFF)** - avec commande intelligente AwoX (AwoX Smart Control application) / télécommande
- › **Compteur d'énergie BLE**
- › **Puissance nominale** - 10 A / max. 2300 W / 230 V
- › **Portée de commande** - jusqu'à 15 m
- › **Connectivité** - Maillage intelligente Bluetooth® (Bluetooth® Smart Mesh)
- › **Version** - GE (Shuko CEE 7/7)

FONCTIONS SUPPLÉMENTAIRES PLUG PLUS

Commande locale et commande à distance externe: Commande locale à l'aide de la technologie de maillage Bluetooth® (Bluetooth® Mesh-Technologie) et commande à distance à l'aide de service en nuage AwoX (AwoX Cloudservice) • **Contrôle vocal:** Soutenu par Amazon Alexa / Google prêt à la maison (Google Home ready) • **Connexion:** Pont Wi-Fi (Wi-Fi Bridge) avec maillage écosystème Bluetooth® (Bluetooth® Mesh ecosystem).



9 002759 979362



9 002759 974763



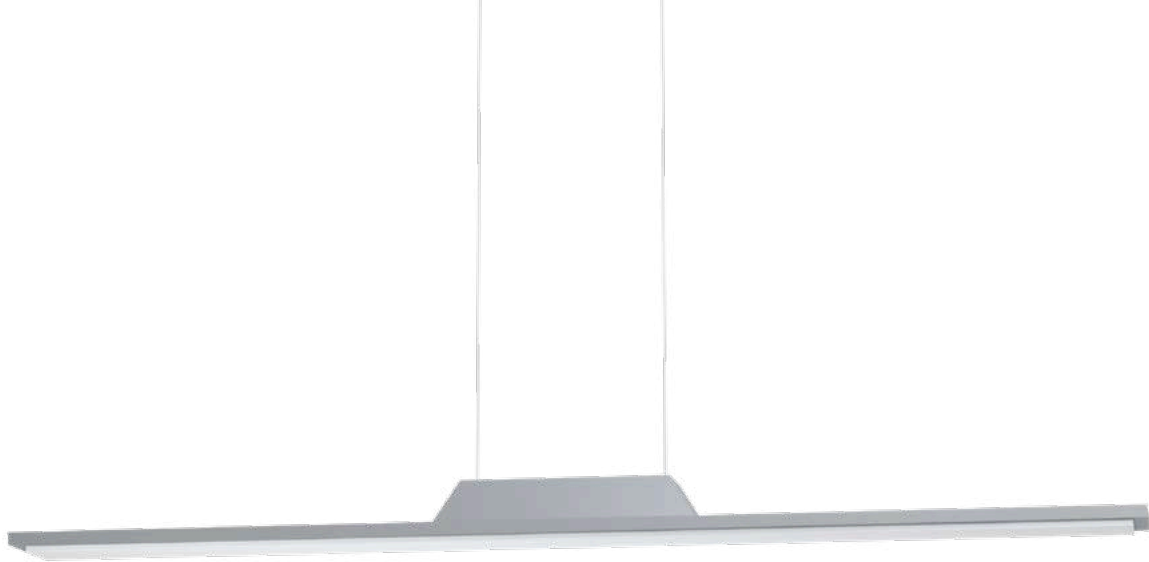

98469



98468



TABRIZ-C

These luminaires inspire with their extremely flat and elegant design.

Diese Leuchten begeistern durch ihre extrem flache und elegante Bauweise.

Ces lumières enthousiasment par leur méthode de construction extrêmement plate et élégante.

98468 TABRIZ-C

ceiling luminaire; aluminium, silver / plastic, satiné
Deckenleuchte; Alu, silber / Kunststoff, satiniert
plafonnier; aluminium, argent / plastique, satiné

L 1190, B 100, H 65



34W 4300lm

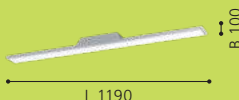

98469 TABRIZ-C

pendant luminaire; aluminium, silver / plastic, satiné
Hängeleuchte; Alu, silber / Kunststoff, satiniert
luminaire en suspension; aluminium, argent / plastique, satiné

L 1190, B 100, H 1100

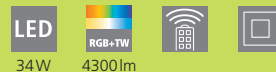

34W 4300lm

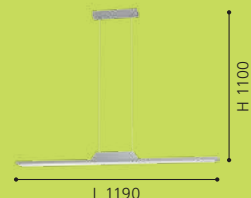

98469





97907



97911

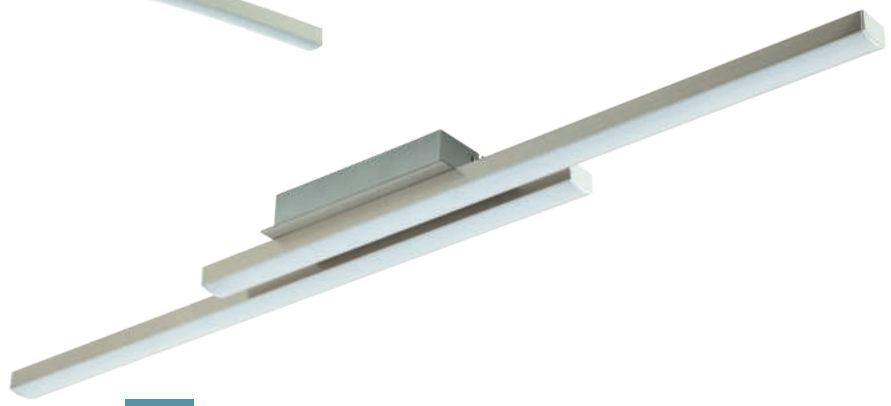

97906



97911 FRAIOLI-C

pendant luminaire; aluminium, satin nickel / plastic, white
 Hängeleuchte; Alu, nickel-matt / Kunststoff, weiss
 luminaire en suspension; aluminium, nickel mat / plastique, blanc

L 1050, B 100, H 1200



2x 17W 4600lm



9 002759 979119

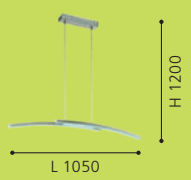

97907 FRAIOLI-C

pendant luminaire; aluminium, satin nickel / plastic, white
 Hängeleuchte; Alu, nickel-matt / Kunststoff, weiss
 luminaire en suspension; aluminium, nickel mat / plastique, blanc

L 1055, B 100, H 1200



2x 17W 4600lm



9 002759 979072

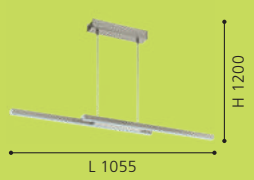

97906 FRAIOLI-C

ceiling luminaire; aluminium, satin nickel / plastic, white
 Deckenleuchte; Alu, nickel-matt / Kunststoff, weiss
 plafonnier; aluminium, nickel mat / plastique, blanc

L 1055, B 120, H 65



2x 17W 4600lm



9 002759 979065





97908

LED



97909

LED



15

97908

97908 FRAIOLI-C

floor luminaire; aluminium, satin nickel / plastic, white
 Stehleuchte; Alu, nickel-matt / Kunststoff, weiss
 lampadaire; aluminium, nickel mat / plastique, blanc

H 1755, Base: B 280, T 280

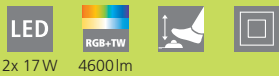

2x 17W 4600lm



9 002759 979089



97909 FRAIOLI-C

ceiling luminaire; aluminium, satin nickel / plastic, white
 Deckenleuchte; Alu, nickel-matt / Kunststoff, weiss
 plafonnier; aluminium, nickel mat / plastique, blanc

L 1050, B 120, H 125



2x 17W 4600lm



9 002759 979096





97812

LED



97811

LED

 DIMMABLE
VIA REMOTE
AND APP

97813

LED

97812 FRATTINA-C

pendant luminaire; steel, satin nickel / plastic, white
Hängeleuchte; Stahl, nickel-matt / Kunststoff, weiss
luminaire en suspension; acier, nickel mat / plastique, blanc

H 1500, Ø 435



27W 3400lm



9 002759 978129

A+



97811 FRATTINA-C

ceiling luminaire; steel, satin nickel / plastic, white
Deckenleuchte; Stahl, nickel-matt / Kunststoff, weiss
plafonnier; acier, nickel mat / plastique, blanc

H 130, Ø 435



27W 3400lm



9 002759 978112

A+

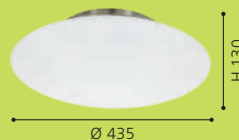

97813 FRATTINA-C

table luminaire; steel, satin nickel / plastic, white
Tischleuchte; Stahl, nickel-matt / Kunststoff, weiss
luminaire de table; acier, nickel mat / plastique, blanc

H 115, Ø 290, Base: Ø 200



18W 2300lm



9 002759 978136

A+





97814

LED



97813

17

97814 FRATTINA-C

floor luminaire; steel, satin nickel / plastic, white
Stehleuchte; Stahl, nickel-matt / Kunststoff, weiss
lampadaire; acier, nickel mat / plastique, blanc

H 1815, Ø 290, Base: Ø 300

LED
18W

RGB-TW
2300lm



Ø 290



H 1815

Ø 300



9 002759 978143

A+



98372



98371

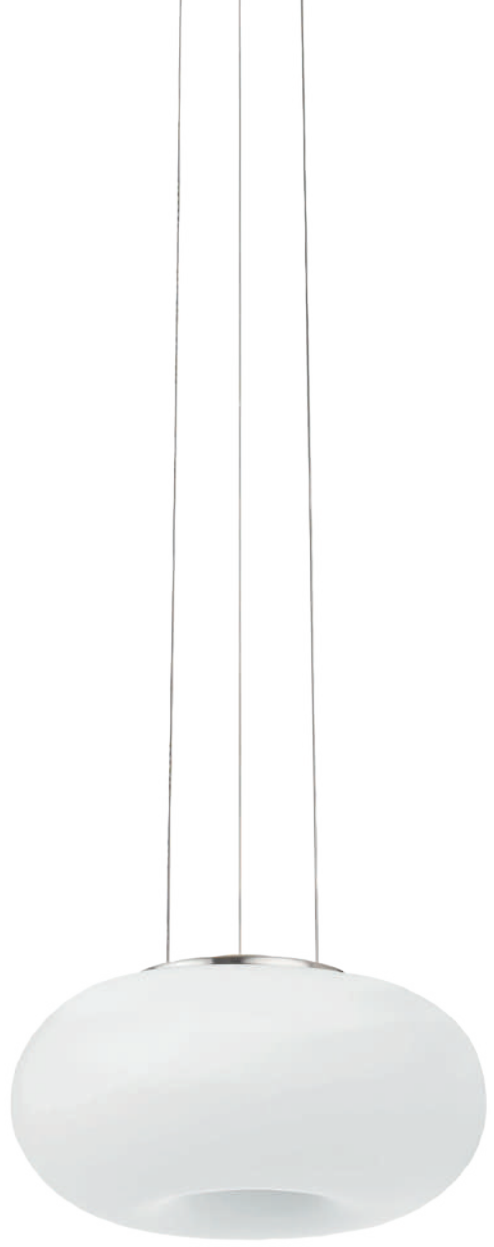

98372



98371 OPTICA-C

pendant luminaire; steel, satin nickel / glass opal-matt, white
Hängeleuchte; Stahl, nickel-matt / Glas opal-matt, weiss
luminaire en suspension; acier, nickel mat / verre opale mat, blanc

H 1500, Ø 375



 21W 2200lm



9 002759 983710



98372 OPTICA-C

pendant luminaire; steel, satin nickel / glass opal-matt, white
Hängeleuchte; Stahl, nickel-matt / Glas opal-matt, weiss
luminaire en suspension; acier, nickel mat / verre opale mat, blanc

H 1500, Ø 445



 26,8W 2950lm



9 002759 983727





98047



98045



98046



98047 COMBA-C

pendant luminaire; steel, white / plastic, white
Hängeleuchte; Stahl, weiss / Kunststoff, weiss
luminaire en suspension; acier, blanc / plastique, blanc

H 1500, Ø 290



18W 2300lm



9 002759 980474

A+



98045 RIODEVA-C

ceiling luminaire; steel, white / plastic, white
Deckenleuchte; Stahl, weiss / Kunststoff, weiss
plafonnier; acier, blanc / plastique, blanc

H 105, Ø 445



27W 3400lm



9 002759 980450

A+



98046 RIODEVA-C

pendant luminaire; steel, white / plastic, white
Hängeleuchte; Stahl, weiss / Kunststoff, weiss
luminaire en suspension; acier, blanc / plastique, blanc

H 1500, Ø 445



27W 3400lm



9 002759 980467

A+





98041 MONEVA-C

pendant luminaire; steel, white / plastic, white
Hängeleuchte; Stahl, weiss / Kunststoff, weiss
luminaire en suspension; acier, blanc / plastique, blanc

H 1500, Ø 405



18W 2300lm



9 002759 980412

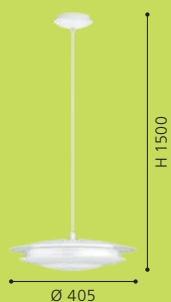

98042 MONEVA-C

pendant luminaire; steel, white / plastic, white
Hängeleuchte; Stahl, weiss / Kunststoff, weiss
luminaire en suspension; acier, blanc / plastique, blanc

H 1500, Ø 485



27W 3400lm



9 002759 980429

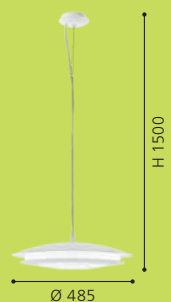

98043 MONEVA-C

pendant luminaire; steel, satin nickel / plastic, white
Hängeleuchte; Stahl, nickel-matt / Kunststoff, weiss
luminaire en suspension; acier, nickel mat / plastique, blanc

H 1500, Ø 405



18W 2300lm



9 002759 980436





98044

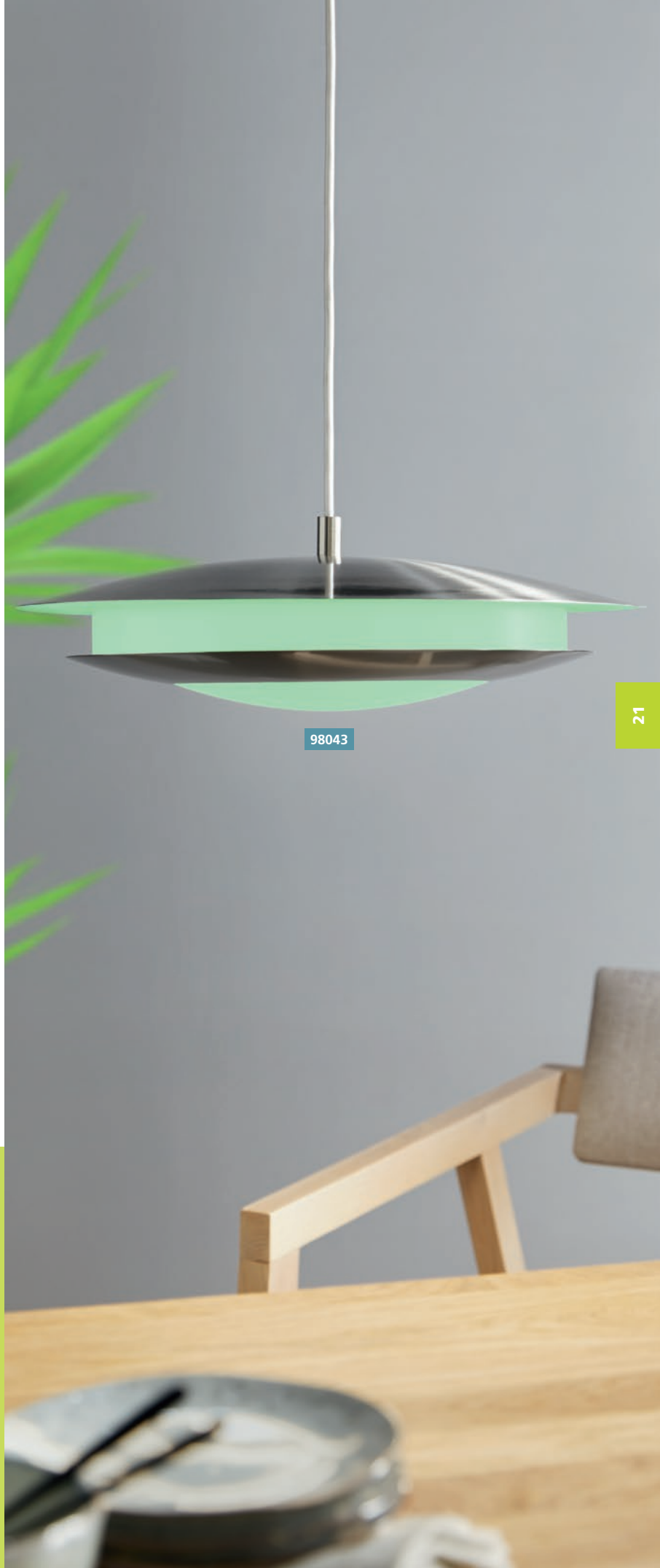

98043

21

98044 MONEVA-C

pendant luminaire; steel, satin nickel / plastic, white
Hängeleuchte; Stahl, nickel-matt / Kunststoff, weiss
luminaire en suspension; acier, nickel mat / plastique, blanc

H 1500, Ø 485



27W 3400lm



9 002759 980443

A+





98427





98605



98606



98427



98427 HORNITOS-C

pendant luminaire; steel, chrome / plastic, satiné
 Hängeleuchte; Stahl, chrom / Kunststoff, satiniert
 luminaire en suspension; acier, chrome / plastique, satiné

L 755, B 515, H 1500



37W 4000lm



9 002759 984274



98605 CERIGNOLA-C

pendant luminaire; steel, aluminium, white / plastic, white
 Hängeleuchte; Stahl, Alu, weiss / Kunststoff, weiss
 luminaire en suspension; acier, aluminium, blanc / plastique, blanc

H 1100, Ø 400



21W 2400lm



9 002759 986056



98606 CERIGNOLA-C

pendant luminaire; steel, aluminium, white / plastic, white
 Hängeleuchte; Stahl, Alu, weiss / Kunststoff, weiss
 luminaire en suspension; acier, aluminium, blanc / plastique, blanc

H 1100, Ø 600



32W 3600lm



9 002759 986063





97921

LED



96684

LED



97918

LED



96684 VOLTAGO-C

wall / ceiling luminaire; steel, white / plastic with crystal effect, white

Wand- / Deckenleuchte; Stahl, weiss / Kunststoff m.Kristalleffekt, weiss

applique / plafonnier; acier, blanc / plastique avec effet cristal, blanc

H 95, Ø 380



17W 2100lm

97918 TOTARI-C

ceiling luminaire; steel, white / plastic, white, chrome

Deckenleuchte; Stahl, weiss / Kunststoff, weiss, chrom

plafonnier; acier, blanc / plastique, blanc, chrome

H 135, Ø 580



34W 5400lm

97921 TOTARI-C

ceiling luminaire; steel, white / plastic, white

Deckenleuchte; Stahl, weiss / Kunststoff, weiss

plafonnier; acier, blanc / plastique, blanc

H 135, Ø 595



34W 5400lm



9 002759 966843



Ø 380



9 002759 979188



Ø 580



9 002759 979218



Ø 595





98459

LED



incl./inkl./inclus



97922

LED



incl./inkl./inclus

97922 TOTARI-C

ceiling luminaire; steel, white / plastic with crystal effect, white
Deckenleuchte; Stahl, weiss / Kunststoff m.Kristalleffekt, weiss
plafonnier; acier, blanc / plastique avec effet cristal, blanc

H 135, Ø 580



34 W 5400 lm

98459 TOTARI-C

ceiling luminaire; steel, white / plastic with crystal effect, white
Deckenleuchte; Stahl, weiss / Kunststoff m.Kristalleffekt, weiss
plafonnier; acier, blanc / plastique avec effet cristal, blanc

H 80, Ø 800



43 W 5850 lm



9 002759 979225



Ø 580



9 002759 984595



Ø 800





32589

LED



96818

LED



96821

LED



32589 GIRON-C

wall / ceiling luminaire; steel, white / plastic, white
Wand- / Deckenleuchte; Stahl, weiss / Kunststoff, weiss
applique / plafonnier; acier, blanc / plastique, blanc

H 90, Ø 300



96821 CAPASSO-C

wall / ceiling luminaire; steel, white / plastic, white, chrome
Wand- / Deckenleuchte; Stahl, weiss / Kunststoff, weiss, chrom
applique / plafonnier; acier, blanc / plastique, blanc, chrome

H 70, Ø 340



96818 COMPETA-C

wall / ceiling luminaire; steel, white / plastic, white, silver, clear
Wand- / Deckenleuchte; Stahl, weiss / Kunststoff, weiss, silber, klar
applique / plafonnier; acier, blanc / plastique, blanc, argent, clair

H 90, Ø 430





96686



96686

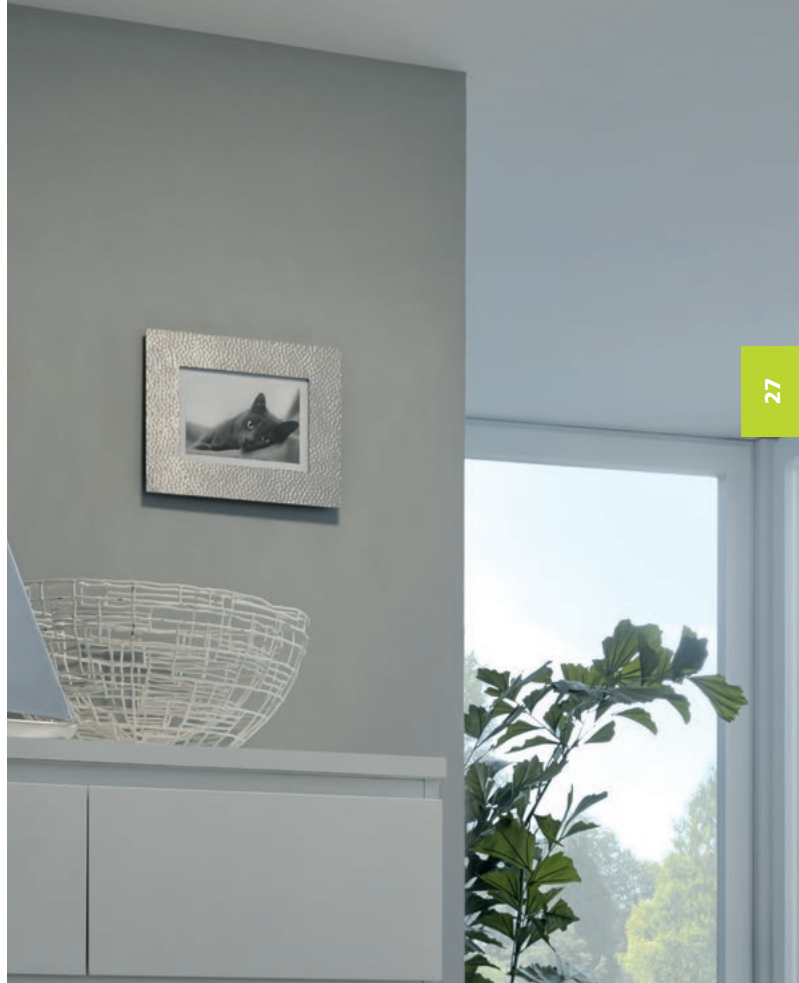

96686 CAPASSO-C

wall / ceiling luminaire; steel, white / plastic, white, chrome
Wand- / Deckenleuchte; Stahl, weiss / Kunststoff, weiss, chrom
applique / plafonnier; acier, blanc / plastique, blanc, chrome

H 85, Ø 340



17W 2100lm





97694 PALOMBARE-C

spot; plastic, steel, aluminium, white / plastic, white
 Spot; Kunststoff, Stahl, Alu, weiss / Kunststoff, weiss
 spot; plastique, acier, aluminium, blanc / plastique, blanc

L 770, B 80

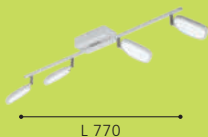

97693 PALOMBARE-C

spot; plastic, steel, aluminium, white / plastic, white
 Spot; Kunststoff, Stahl, Alu, weiss / Kunststoff, weiss
 spot; plastique, acier, aluminium, blanc / plastique, blanc

L 590, B 80

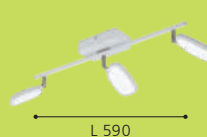

97692 PALOMBARE-C

spot; plastic, steel, aluminium, white / plastic, white
 Spot; Kunststoff, Stahl, Alu, weiss / Kunststoff, weiss
 spot; plastique, acier, aluminium, blanc / plastique, blanc

L 365, B 80

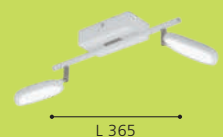



97691

LED



97694

97691

29



DIMMABLE
VIA REMOTE
AND APP



97691 PALOMBARE-C

spot; plastic, steel, aluminium, white / plastic, white
Spot; Kunststoff, Stahl, Alu, weiss / Kunststoff, weiss
spot; plastique, acier, aluminium, blanc / plastique, blanc

L 80, H 150



1x 5W 1x 600lm



9 002759 976910

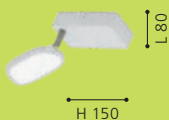



97717

LED



97716

LED



97715

LED

DIMMABLE
VIA REMOTE
AND APP



97717 CORROPOLI-C

spot; plastic, steel, satin nickel / plastic, white
Spot; Kunststoff, Stahl, nickel-matt / Kunststoff, weiss
spot; plastique, acier, nickel mat / plastique, blanc

L 770, B 80



4x 5W
4x
600lm



9 002759 977177



L 770

97716 CORROPOLI-C

spot; plastic, steel, satin nickel / plastic, white
Spot; Kunststoff, Stahl, nickel-matt / Kunststoff, weiss
spot; plastique, acier, nickel mat / plastique, blanc

L 590, B 80



3x 5W
3x
600lm



9 002759 977160



L 590

97715 CORROPOLI-C

spot; plastic, steel, satin nickel / plastic, white
Spot; Kunststoff, Stahl, nickel-matt / Kunststoff, weiss
spot; plastique, acier, nickel mat / plastique, blanc

L 365, B 80



2x 5W
2x
600lm



9 002759 977153



L 365

97716



97714

LED



CORROPOLI-C

These lamps light to both sides.

Diese Leuchte strahlt beidseitig.

Ces lampes éclairent sur les deux côtés.

97714

31



97714 CORROPOLI-C

spot; plastic, steel, satin nickel / plastic, white

Spot; Kunststoff, Stahl, nickel-matt / Kunststoff, weiss

spot; plastique, acier, nickel mat / plastique, blanc

L 80, H 150



1x 5W

1x

600lm



9 002759 977146

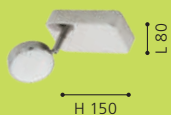



97959



97958



97961



97958 SARSINA-C

ceiling luminaire; aluminium, white / plastic, white
Deckenleuchte; Alu, weiss / Kunststoff, weiss
plafonnier; aluminium, blanc / plastique, blanc

H 50, Ø 300



16W 2100lm

97959 SARSINA-C

ceiling luminaire; aluminium, white / plastic, white
Deckenleuchte; Alu, weiss / Kunststoff, weiss
plafonnier; aluminium, blanc / plastique, blanc

H 50, Ø 450



21W 2900lm

97961 SARSINA-C

ceiling luminaire; aluminium, white / plastic, white
Deckenleuchte; Alu, weiss / Kunststoff, weiss
plafonnier; aluminium, blanc / plastique, blanc

H 50, Ø 600



34W 4250lm



9 002759 979584



9 002759 979591



9 002759 979614





incl./inkl./inclus



98566



98566 SARSINA-C

ceiling luminaire; steel, white / plastic, white
Deckenleuchte; Stahl, weiss / Kunststoff, weiss
plafonnier; acier, blanc / plastique, blanc

H 50, Ø 800

LED

45W

RGB+TW

5500lm



9 002759 985660



Ø 800



97958





incl./inkl./inclus

incl./inkl./inclus

97629

LED

96662

LED



incl./inkl./inclus

96663

LED

96662 SALOBRENA-C

ceiling luminaire; aluminium, white / plastic, white
Deckenleuchte; Alu, weiss / Kunststoff, weiss
plafonnier; aluminium, blanc / plastique, blanc

L 300, B 300, H 50



16W 2000lm

97629 SALOBRENA-C

ceiling luminaire; aluminium, white / plastic, white
Deckenleuchte; Alu, weiss / Kunststoff, weiss
plafonnier; aluminium, blanc / plastique, blanc

L 450, B 450, H 50



21W 2500lm

96663 SALOBRENA-C

ceiling luminaire; aluminium, white / plastic, white
Deckenleuchte; Alu, weiss / Kunststoff, weiss
plafonnier; aluminium, blanc / plastique, blanc

L 595, B 595, H 50



34W 4300lm



A++



A+



A++





96664

LED



incl./inkl./inclus



98089

LED



incl./inkl./inclus

ACCESSORIES INCLUDED

35

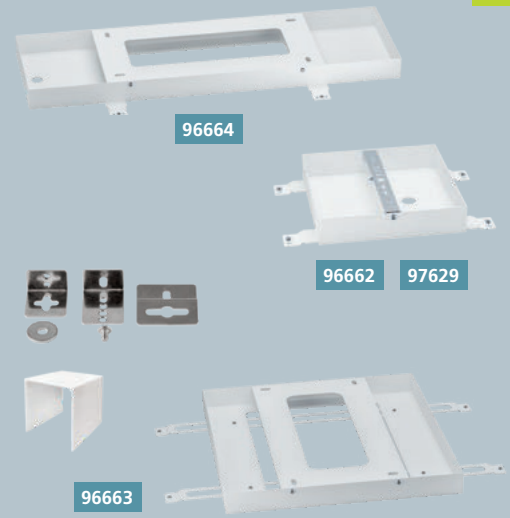

Zubehör inkludiert
Accessoires inclus

96664 SALOBRENA-C

ceiling luminaire; aluminium, white / plastic, white
Deckenleuchte; Alu, weiss / Kunststoff, weiss
plafonnier; aluminium, blanc / plastique, blanc

L 1200, B 300, H 50



34W 4300lm

98089 SALOBRENA-C

ceiling luminaire; aluminium, white / plastic, white
Deckenleuchte; Alu, weiss / Kunststoff, weiss
plafonnier; aluminium, blanc / plastique, blanc

L 1195, B 100, H 45



34W 4500lm

ACCESSORIES OPTIONAL



Zubehör optional
Accessoires optional

see/siehe/voir www.eglo.com



9 002759 966645



9 002759 980894



A++

A+



32881

LED

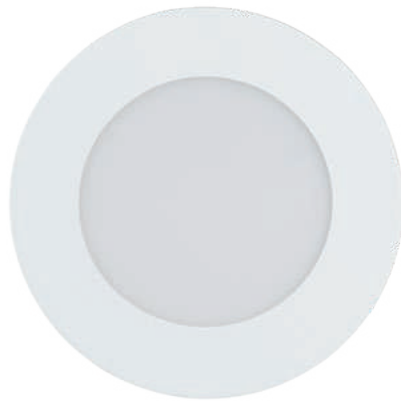

32737

LED

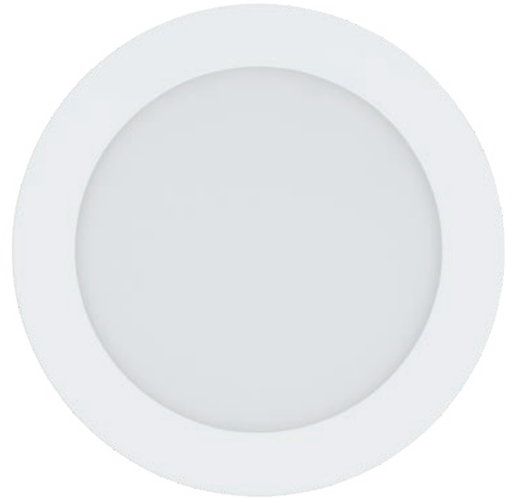



32738

LED

32881 FUEVA-C

recessed luminaire; cast metal, white / plastic, white
Einbauleuchte; Metallguss, weiss / Kunststoff, weiss
luminaire encastrable; fonte métallique, blanc / plastique, blanc

Ø 85, ET 30



LED RGB+TW  

3x 3W 3x 360lm Ø74

32737 FUEVA-C

recessed luminaire; cast metal, white / plastic, white
Einbauleuchte; Metallguss, weiss / Kunststoff, weiss
luminaire encastrable; fonte métallique, blanc / plastique, blanc

Ø 120, ET 30



LED RGB+TW  

5,4W 700lm Ø108

32738 FUEVA-C

recessed luminaire; cast metal, white / plastic, white
Einbauleuchte; Metallguss, weiss / Kunststoff, weiss
luminaire encastrable; fonte métallique, blanc / plastique, blanc

Ø 170, ET 30

LED RGB+TW  

10,5W 1200lm Ø155



9 002759 328818



Ø 85



9 002759 327378



Ø 120



9 002759 327385



Ø 170



DIMMABLE
VIA REMOTE
AND APP

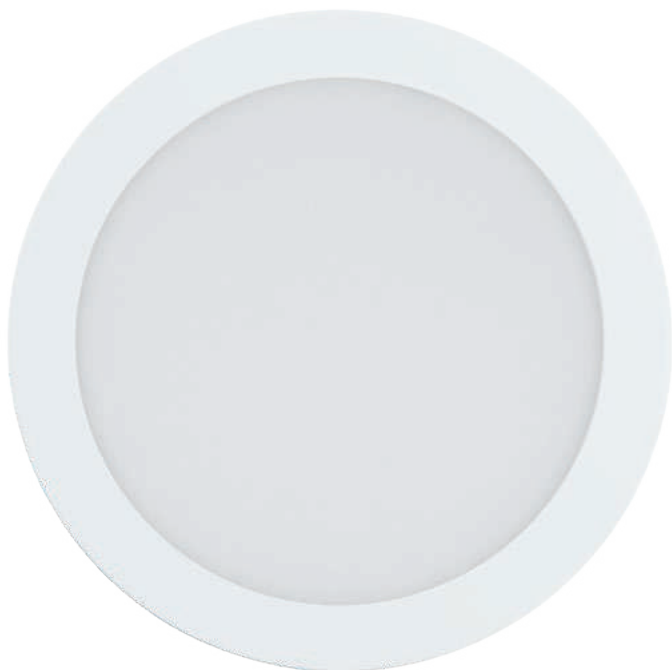

96668

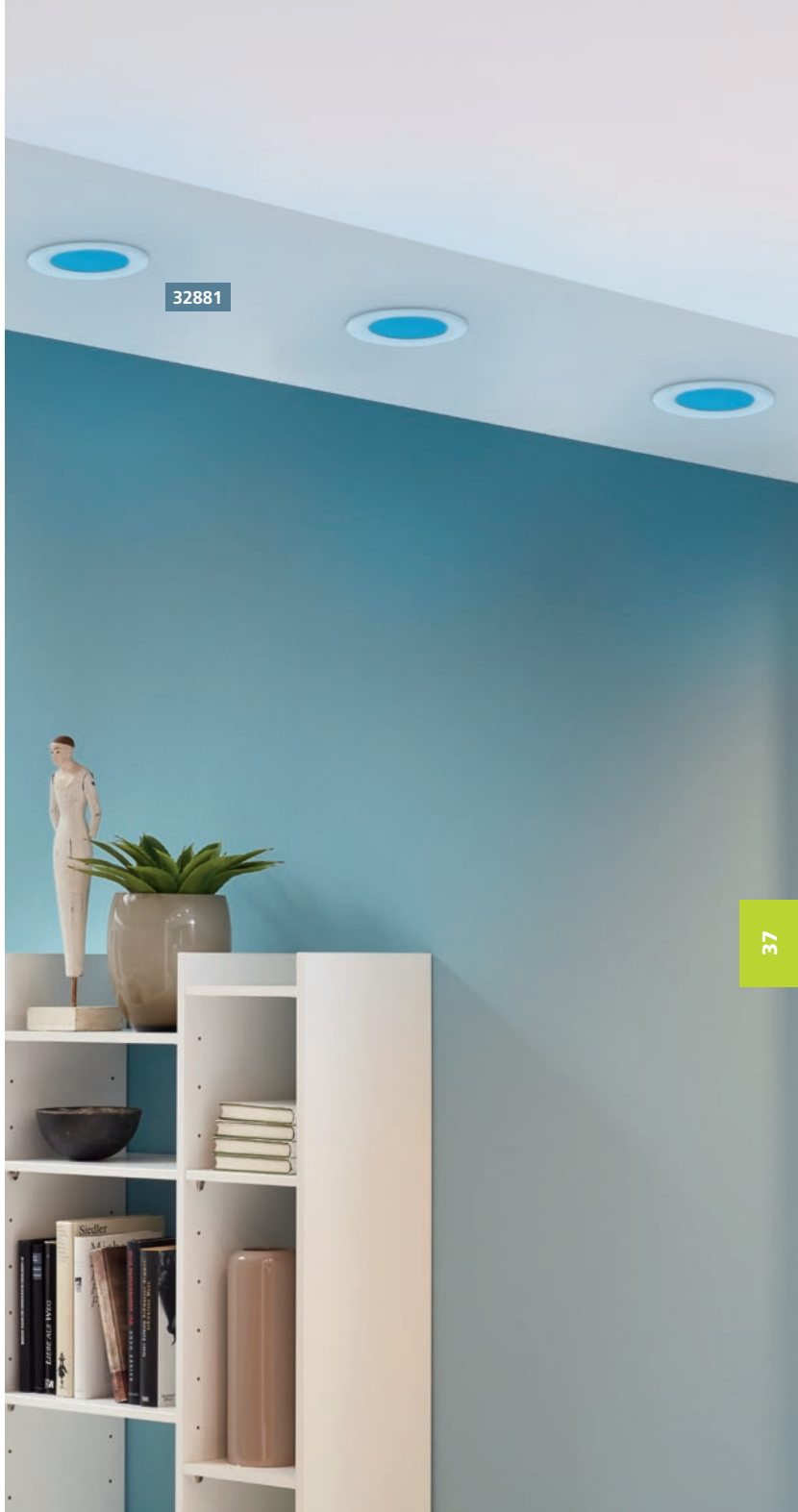

37

96668 FUEVA-C

recessed luminaire; cast metal, white / plastic, white
Einbauleuchte; Metallguss, weiss / Kunststoff, weiss
luminaire encastrable; fonte métallique, blanc / plastique, blanc

Ø 225, ET 30

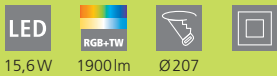

15,6W 1900lm Ø207



Ø 225





32882



32753



32754



32882 FUEVA-C

recessed luminaire; cast metal, satin nickel / plastic, white
 Einbauleuchte; Metallguss, nickel-matt / Kunststoff, weiss
 luminaire encastrable; fonte métallique, nickel mat / plastique, blanc

Ø 85, ET 30

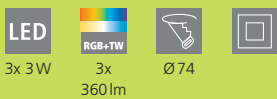

3x 3W 3x Ø74 360lm

32753 FUEVA-C

recessed luminaire; cast metal, satin nickel / plastic, white
 Einbauleuchte; Metallguss, nickel-matt / Kunststoff, weiss
 luminaire encastrable; fonte métallique, nickel mat / plastique, blanc

Ø 120, ET 30

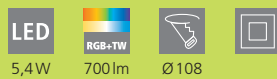

5,4W 700lm Ø108

32754 FUEVA-C

recessed luminaire; cast metal, satin nickel / plastic, white
 Einbauleuchte; Metallguss, nickel-matt / Kunststoff, weiss
 luminaire encastrable; fonte métallique, nickel mat / plastique, blanc

Ø 170, ET 30



10,5W 1200lm Ø155



9 002759 328825



Ø 85



9 002759 327538



Ø 120



9 002759 327545



Ø 170



96676



39

96676 FUEVA-C

recessed luminaire; cast metal, satin nickel / plastic, white
Einbauleuchte; Metallguss, nickel-matt / Kunststoff, weiss
luminaire encastrable; fonte métallique, nickel mat / plastique,
blanc

Ø 225, ET 30

LED

15,6W

RGB+TW

1900lm



Ø 207



Ø 225



96669



96671



96669 FUEVA-C

surface-mounted luminaire; cast metal, white / plastic, white
Aufbauleuchte; Metallguss, weiss / Kunststoff, weiss
luminaire en saillie; fonte métallique, blanc / plastique, blanc

H 40, Ø 225



15,6W 2000lm

96671 FUEVA-C

surface-mounted luminaire; cast metal, white / plastic, white
Aufbauleuchte; Metallguss, weiss / Kunststoff, weiss
luminaire en saillie; fonte métallique, blanc / plastique, blanc

H 40, Ø 300



21W 2700lm



9 002759 966690

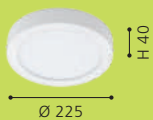

9 002759 966713

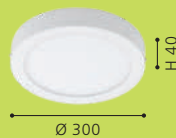



96672



96673



96672 FUEVA-C

surface-mounted luminaire; cast metal, white / plastic, white
 Aufbauleuchte; Metallguss, weiss / Kunststoff, weiss
 luminaire en saillie; fonte métallique, blanc / plastique, blanc

L 225, B 225, H 40



15,6W 2000lm

96673 FUEVA-C

surface-mounted luminaire; cast metal, white / plastic, white
 Aufbauleuchte; Metallguss, weiss / Kunststoff, weiss
 luminaire en saillie; fonte métallique, blanc / plastique, blanc

L 300, B 300, H 40



21W 2700lm



9 002759 966720



9 002759 966737

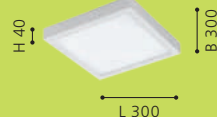



96677



96678



96677 FUEVA-C

surface-mounted luminaire; cast metal, satin nickel / plastic, white

Aufbauleuchte; Metallguss, nickel-matt / Kunststoff, weiss
luminaire en saillie; fonte métallique, nickel mat / plastique, blanc

H 40, Ø 225



15,6W 2000lm

96678 FUEVA-C

surface-mounted luminaire; cast metal, satin nickel / plastic, white

Aufbauleuchte; Metallguss, nickel-matt / Kunststoff, weiss
luminaire en saillie; fonte métallique, nickel mat / plastique, blanc

H 40, Ø 300



21W 2700lm



9 002759 966775

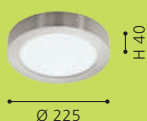

9 002759 966782

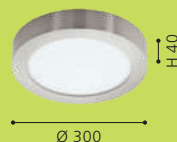



96679



96681



96679 FUEVA-C

surface-mounted luminaire; cast metal, satin nickel / plastic, white

Aufbauleuchte; Metallguss, nickel-matt / Kunststoff, weiss
luminaire en saillie; fonte métallique, nickel mat / plastique, blanc

L 225, B 225, H 40



15,6W 2000lm

96681 FUEVA-C

surface-mounted luminaire; cast metal, satin nickel / plastic, white

Aufbauleuchte; Metallguss, nickel-matt / Kunststoff, weiss
luminaire en saillie; fonte métallique, nickel mat / plastique, blanc

L 300, B 300, H 40



21W 2700lm



9 002759 966799



9 002759 966812

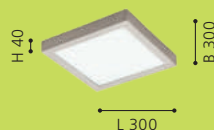

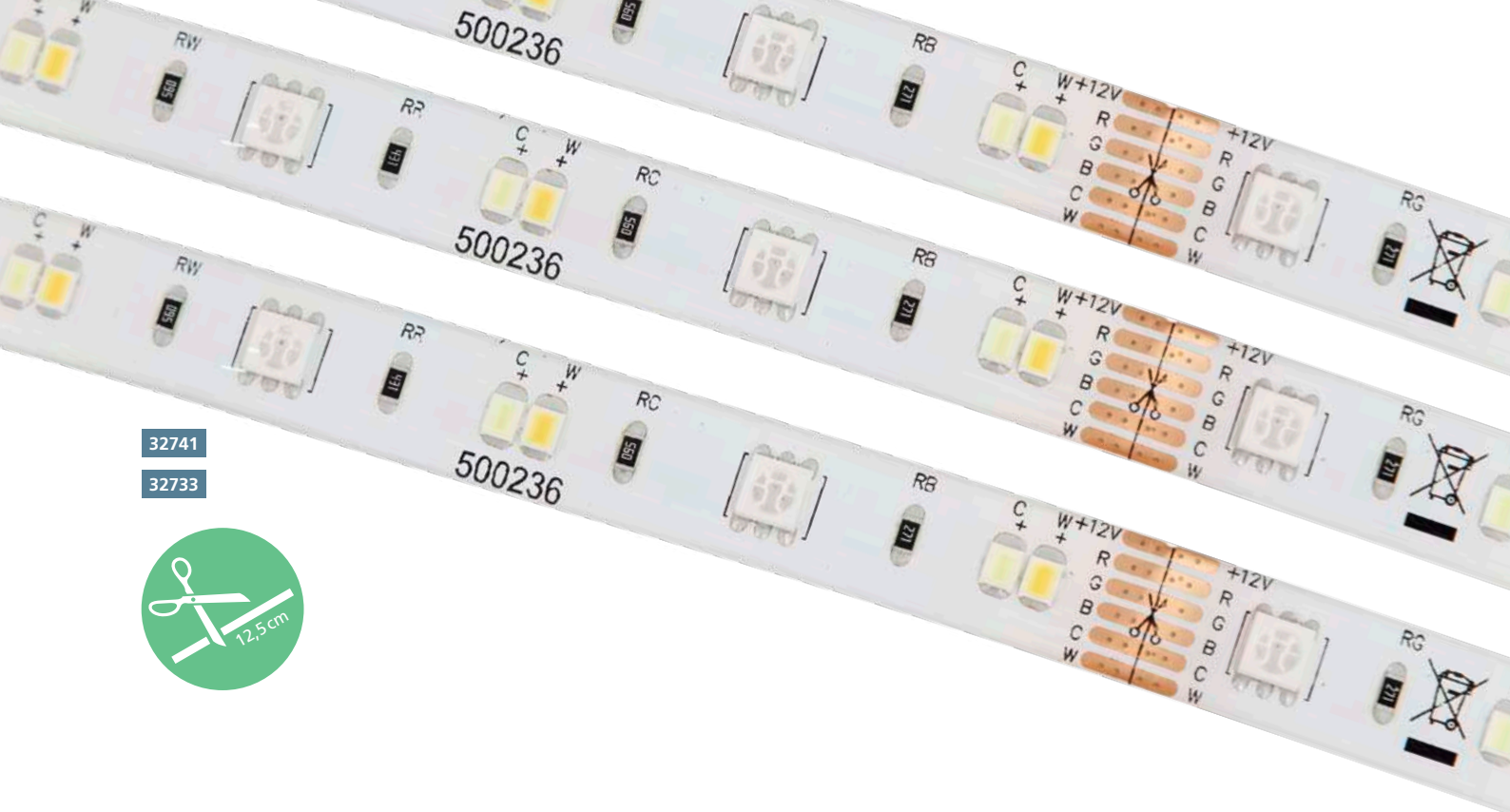

32741

32733

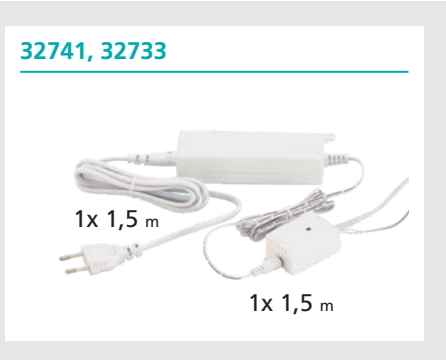

32741 STRIP-C

bar / strip luminaire; plastic, white
 Leuchtband/-stab; Kunststoff, weiss
 bande lumineuse / bâton l; plastique, blanc

L 3000, B 12, H 3

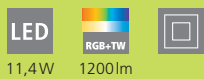

11,4W 1200lm

32733 STRIP-C

bar / strip luminaire; plastic, white
 Leuchtband/-stab; Kunststoff, weiss
 bande lumineuse / bâton l; plastique, blanc

L 5000, B 12, H 3



19W 2000lm



9 002759 327415



L 3000



9 002759 327330



L 5000





32741



EGLO CONNECT BATHROOM



OVERVIEW

EGLO CONNECT BATHROOM



FUEVA-C
48



FUEVA-C
49



TABIANO-C
49



TABIANO-C
49

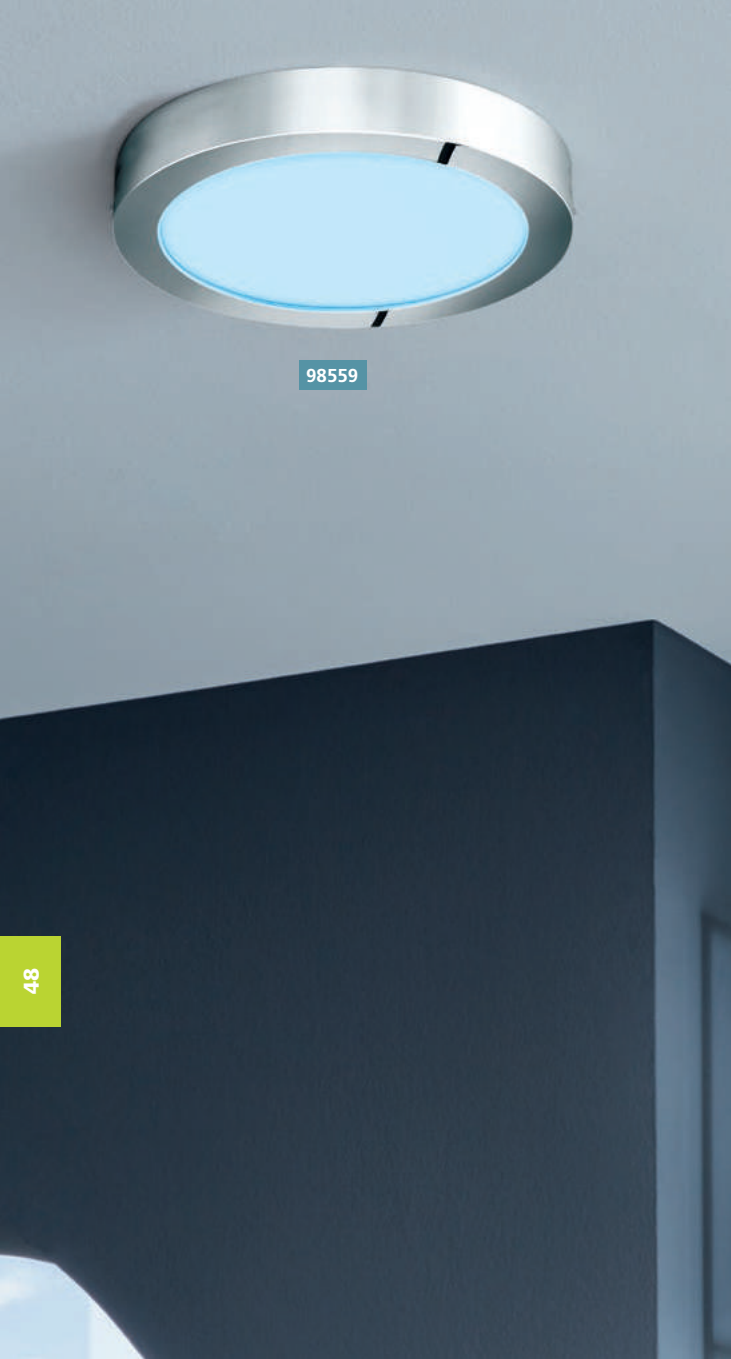

98559

48



98559

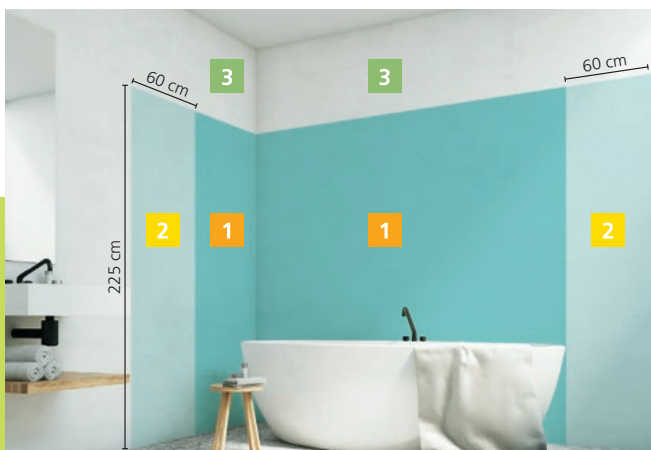

FUEVA-C

These luminaires are protected against splash water.

Diese Leuchten sind gegen Spritzwasser geschützt.

Les luminaires sont protégées contre les éclaboussures d'eau.

	0	1	2	3
IP44				
EU	X	X	✓	✓
FR	X	X	X	✓

98559 FUEVA-C

surface-mounted luminaire; cast metal, chrome / plastic, white
 Aufbauleuchte; Metallguss, chrom / Kunststoff, weiss
 luminaire en saillie; fonte métallique, chrome / plastique, blanc

H 40, Ø 300

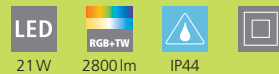

LED

RGB-TW
2800 lm

IP44



9 002759 985592





98561



98451



98452



98561 FUEVA-C

surface-mounted luminaire; cast metal, chrome / plastic, white
 Aufbauleuchte; Metallguss, chrom / Kunststoff, weiss
 luminaire en saillie; fonte métallique, chrome / plastique, blanc

L 300, B 300, H 40



21 W 2800 lm IP44

98451 TABIANO-C

mirror luminaire; steel, chrome / plastic, white
 Spiegelleuchte; Stahl, chrom / Kunststoff, weiss
 applique pour miroir; acier, chrome / plastique, blanc

L 605, H 70, A 130

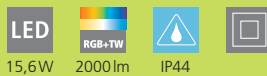

15,6 W 2000 lm IP44

98452 TABIANO-C

mirror luminaire; steel, chrome / plastic, white
 Spiegelleuchte; Stahl, chrom / Kunststoff, weiss
 applique pour miroir; acier, chrome / plastique, blanc

L 905, H 70, A 130



21 W 2700 lm IP44



9 002759 985615

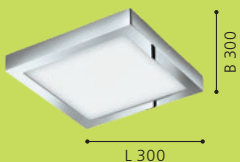

L 300

B 300



9 002759 984519

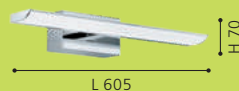

L 605

H 70



9 002759 984526

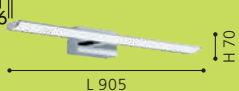

L 905

H 70



EGLO CONNECT OUTDOOR



OVERVIEW

EGLO CONNECT OUTDOOR



CONNECT SENSOR
52



ARGOLIS-C
54



ARGOLIS-C
54



ARGOLIS-C
54



ARGOLIS-C
55



LOCANA-C
57



PIOVE-C
57



TORAZZA-C
58



VERRES-C
59



MARCHESA-C
59



FRANCARI-C
59



CALDIERO-C
60



CALDIERO-C
61



NISIA-C
62



NISIA-C
62



NISIA-C
62



VERLUCCA-C
65



VERLUCCA-C
65



NEMA 1-C
65



MONTEROLO-C
66



MONTEROLO-C
67



MONTEROLO-C
67



MONTEROLO-C
67



Corner Mount
68



Corner Mount
68

CONNECT SENSOR

ADVANTAGES

- › **IP44 Safety**
- › **No cabling necessary**
The CONNECT SENSOR is battery-operated, so that no difficult cabling is necessary. The sensor can be mounted directly on the wall. With the mounting bracket (included in the delivery), you can easily adjust the detection range to your needs. This permits fine adjustment by 30 degrees to all directions.
- › **Night mode**
The Night mode allows automatic switching when the preset brightness threshold is reached.
- › **Movement detection**
When Night movement detection is enabled the CONNECT SENSOR turns on the luminaires with the chosen light intensity when movement is detected. The light will turn off after the selected time when no movement is detected.
- › **Night mode and motion detection can be used separately or in combination.**

VORTEILE

- › **IP44 Schutz**
- › **Keine Verkabelung notwendig**
Der CONNECT SENSOR ist batteriebetrieben, so dass keine Verkabelung erforderlich ist. Der Sensor kann direkt an die Wand montiert werden. Mit der Montagehalterung (im Lieferumfang enthalten) kannst du den Erfassungsbereich ganz einfach an deine Bedürfnisse anpassen. Dadurch ist eine Feinjustierung bis zu 30 Grad in allen Richtungen möglich.
- › **Nachtmodus**
Der Nachtmodus ermöglicht das automatische Einschalten bei Erreichen der voreingestellten Helligkeitsschwelle.
- › **Bewegungserkennung**
Wenn eine Bewegung detektiert wird, schaltet der CONNECT SENSOR die Leuchten mit der voreingestellten Lichtintensität ein. Das Licht schaltet sich nach der definierten Zeit wieder aus, wenn keine weitere Bewegung erkannt wird.
- › **Nachtmodus und Bewegungserkennung können getrennt oder in Kombination verwendet werden.**

ADVANTAGES

- › **Protection IP44**
- › **Aucun câble nécessaire**
Le CONNECT SENSOR est alimenté par batterie, donc aucun câblage difficile n'est nécessaire. Avec le support de montage (inclus dans la livraison), tu peux facilement ajuster l'étendue de la détection à tes besoins. Ce faisant, un réglage de 30 degrés dans toutes les directions est possible.
- › **Mode de nuit (Night mode)**
Le mode nuit permet l'allumage automatique lorsque le seuil de luminosité pré-réglé est atteint.
- › **Détection de mouvement**
Lorsque la détection de mouvement nocturne est activée, le CONNECT SENSOR allume les luminaires avec l'intensité lumineuse présélectionnée lorsqu'un mouvement est détecté. Si aucun mouvement n'est détecté, la lumière s'éteindra après la période sélectionnée.
- › **Le mode nuit et la détection de mouvement peuvent être utilisés séparément ou en combinaison.**



97475



Mounting bracket incl.
Montagehalterung inkl.
Support de montage incl.

97475 CONNECT SENSOR

accessory; plastic, white
Zubehör; Kunststoff, weiss
accessoire; plastique, blanc

L 60, H 60, A 40

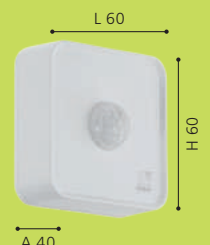
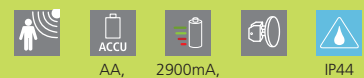



97475



98172
LED



98171
LED



98173
LED

98171 ARGOLIS-C

wall / ceiling luminaire; cast aluminium, white / plastic, white
Wand- / Deckenleuchte; Aluguss, weiss / Kunststoff, weiss
applique / plafonnier; fonte d'aluminium, blanc / plastique, blanc

H 35, Ø 225

LED 16,5W tunable WHITE 1600lm IP44

98172 ARGOLIS-C

wall / ceiling luminaire; cast aluminium, white / plastic, white
Wand- / Deckenleuchte; Aluguss, weiss / Kunststoff, weiss
applique / plafonnier; fonte d'aluminium, blanc / plastique, blanc

L 300, B 300, H 35

LED 22W tunable WHITE 2600lm IP44

98173 ARGOLIS-C

wall / ceiling luminaire; cast aluminium, anthracite / plastic, white
Wand- / Deckenleuchte; Aluguss, anthrazit / Kunststoff, weiss
applique / plafonnier; fonte d'aluminium, anthracite / plastique, blanc

H 35, Ø 225

LED 16,5W tunable WHITE 1600lm IP44



A+

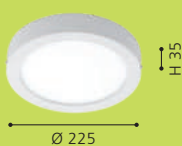

A+

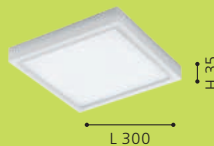

A+

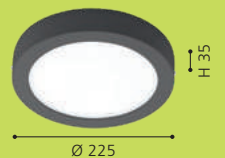

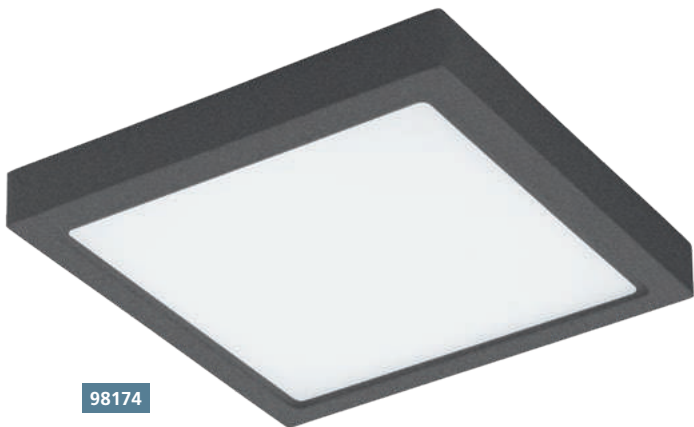

98174

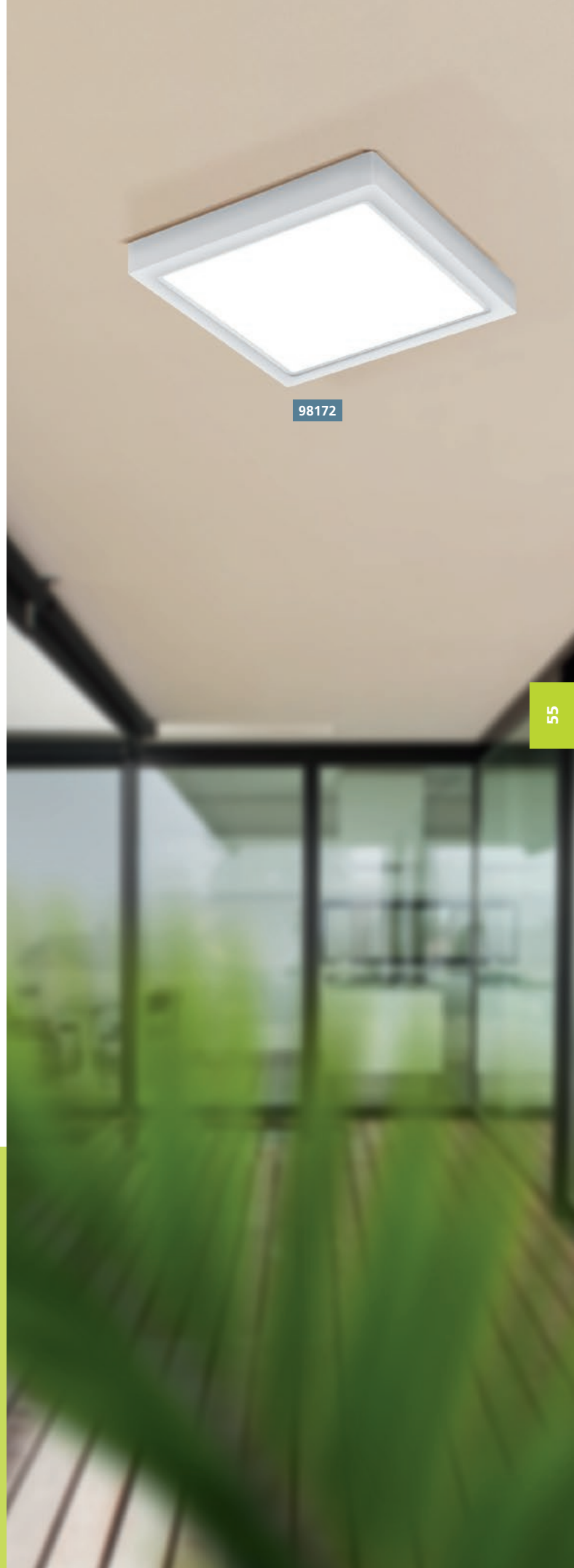

98172

55

98174 ARGOLIS-C

wall / ceiling luminaire; cast aluminium, anthracite / plastic, white

Wand- / Deckenleuchte; Aluguss, anthrazit / Kunststoff, weiss
applique / plafonnier; fonte d'aluminium, anthracite / plastique, blanc

L 300, B 300, H 35

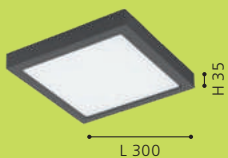



97237





97299



97237



97295



97237 LOCANA-C

wall / ceiling luminaire; zinc-plated steel, anthracite / plastic, white
Wand- / Deckenleuchte; Stahl verzinkt, anthrazit / Kunststoff, weiss

applique / plafonnier; acier galvanisé, anthracite / plastique, blanc
H 95, Ø 260



14W 1400lm IP44

97299 LOCANA-C

wall / ceiling luminaire; zinc-plated steel, silver / plastic, white
Wand- / Deckenleuchte; Stahl verzinkt, silber / Kunststoff, weiss
applique / plafonnier; acier galvanisé, argent / plastique, blanc

H 95, Ø 260



14W 1400lm IP44

97295 PIOVE-C

wall / ceiling luminaire; cast aluminium, black / plastic, white
Wand- / Deckenleuchte; Aluguss, schwarz / Kunststoff, weiss
applique / plafonnier; fonte d'aluminium, noir / plastique, blanc

L 250, H 250, A 80



14W 1400lm IP44



9 002759 972370



9 002759 972998



9 002759 972950





1x A-F 3x 0-9

Letters and numbers included in delivery.
 Buchstaben und Zahlen im Lieferumfang enthalten.
 Les lettres et les nombres sont inclus dans la livraison.



This luminaire is delivered with freely positionable ornamental elements which are attached by means of adhesive tape.

Diese Leuchte wird mit frei positionierbaren Zierelementen geliefert, welche mittels Klebeband angebracht werden.

Ce luminaire est livrée avec éléments de décoration qui sont attachés au moyen du ruban adhésif.



97219



58



97219

97219 TORAZZA-C

wall luminaire; plastic, steel, anthracite / plastic, satined
 Wandleuchte; Kunststoff, Stahl, anthrazit / Kunststoff, satiniert
 applique; plastique, acier, anthracite / plastique, satiné

L 215, H 215, A 70

LED warm WHITE IP44

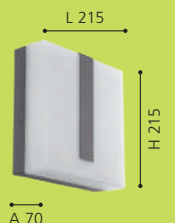



98234



97239



98145



97239 VERRES-C

wall luminaire; stainless steel, plastic, stainless steel, white / plastic, white

Wandleuchte; Edelstahl, Kunststoff, edelstahl, weiss / Kunststoff, weiss

applique; acier inoxydable, plastique, acier inoxydable, blanc / plastique, blanc

L 180, H 290, A 90



9 002759 972394



98234 FRANCARI-C

wall luminaire; cast aluminium, black / plastic, white

Wandleuchte; Aluguss, schwarz / Kunststoff, weiss

applique; fonte d'aluminium, noir / plastique, blanc

L 220, H 255, A 250



9 002759 982348



98145 MARCHESA-C

wall / ceiling luminaire; stainless steel, stainless steel / plastic, white

Wand- / Deckenleuchte; Edelstahl, edelstahl / Kunststoff, weiss

applique / plafonnier; acier inoxydable, acier inoxydable / plastique, blanc

H 70, Ø 300



9 002759 981457





97484



97482

LED

97482 CALDIERO-C

wall luminaire; zinc-plated steel, anthracite / plastic, white
Wandleuchte; Stahl verzinkt, anthrazit / Kunststoff, weiss
applique; acier galvanisé, anthracite / plastique, blanc

L 140, H 240, A 190



E27



1x 9W

warm
WHITE

1x

806lm



IP44



9 002759 974824



A+



INCL.





97483



97484

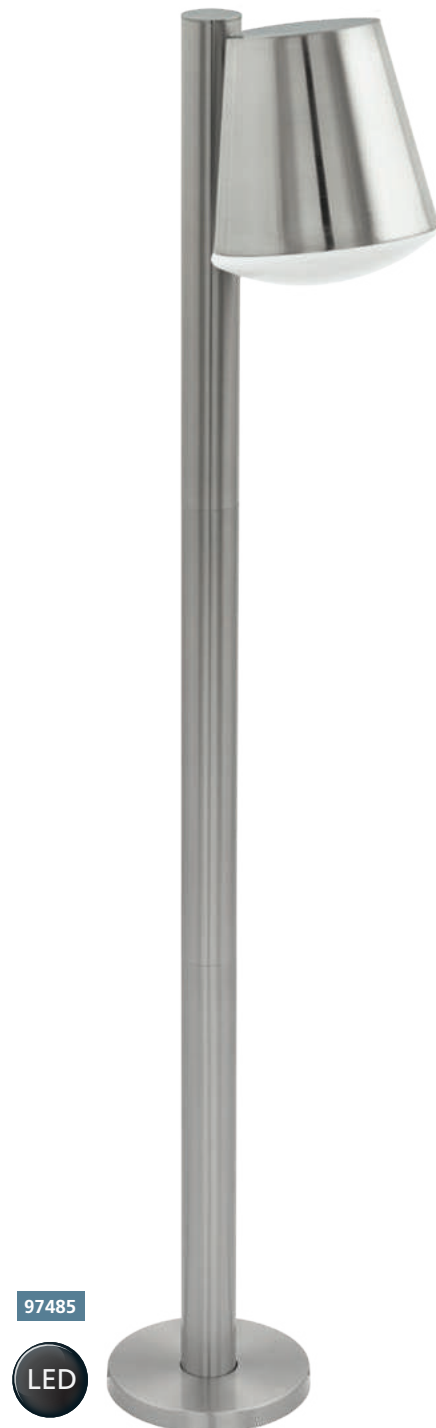

97485



97483 CALDIERO-C

floor luminaire; zinc-plated steel, anthracite / plastic, white
 Stehleuchte; Stahl verzinkt, anthrazit / Kunststoff, weiss
 lampadaire; acier galvanisé, anthracite / plastique, blanc

97484 CALDIERO-C

wall luminaire; stainless steel, stainless steel / plastic, white
 Wandleuchte; Edelstahl, edelstahl / Kunststoff, weiss
 applique; acier inoxydable, acier inoxydable / plastique, blanc

97485 CALDIERO-C

floor luminaire; stainless steel, stainless steel / plastic, white
 Stehleuchte; Edelstahl, edelstahl / Kunststoff, weiss
 lampadaire; acier inoxydable, acier inoxydable / plastique, blanc

L 240, B 140, H 965, Base: Ø 140



L 140, H 240, A 190



L 240, B 140, H 965, Base: Ø 140

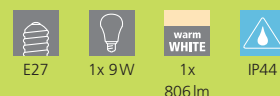

97247

LED



97248

LED



97249

LED

**97247 NISIA-C**

wall luminaire; stainless steel, stainless steel / plastic, white
Wandleuchte; Edelstahl, edelstahl / Kunststoff, weiss
applique; acier inoxydable, acier inoxydable / plastique, blanc

L 200, H 315, A 220



E27



1x 9W



1x

806lm



IP44



9 002759 972479

**97248 NISIA-C**

pedestal luminaire; stainless steel, stainless steel / plastic, white
Sockelleuchte; Edelstahl, edelstahl / Kunststoff, weiss
luminaire pour socle; acier inoxydable, acier inoxydable /
plastique, blanc

H 525, Ø 200, Base: Ø 140



E27



1x 9W



1x

806lm



IP44



9 002759 972486

**97249 NISIA-C**

floor luminaire; stainless steel, stainless steel / plastic, white
Stehleuchte; Edelstahl, edelstahl / Kunststoff, weiss
lampadaire; acier inoxydable, acier inoxydable / plastique, blanc

H 980, Ø 200, Base: Ø 140



E27



1x 9W



1x

806lm



IP44

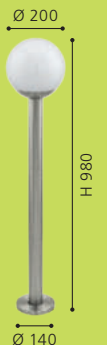

9 002759 972493





97247





97446



97447

LED



97446

LED



98052

LED



97447 VERLUCCA-C

floor luminaire; zinc-plated steel, black / glass, clear, black
Stehleuchte; Stahl verzinkt, schwarz / Glas, klar, schwarz
lampadaire; acier galvanisé, noir / verre, clair, noir

97446 VERLUCCA-C

wall luminaire; zinc-plated steel, black / glass, clear, black
Wandleuchte; Stahl verzinkt, schwarz / Glas, klar, schwarz
applique; acier galvanisé, noir / verre, clair, noir

98052 NEMA 1-C

ground spike; plastic, black / plastic, transparent
Erdspieß; Kunststoff, schwarz / Kunststoff, transparent
piquet de terre; plastique, noir / plastique, transparent

H 990, Ø 210, Base: Ø 140



L 210, H 265, A 245



L 130, B 60, H 245



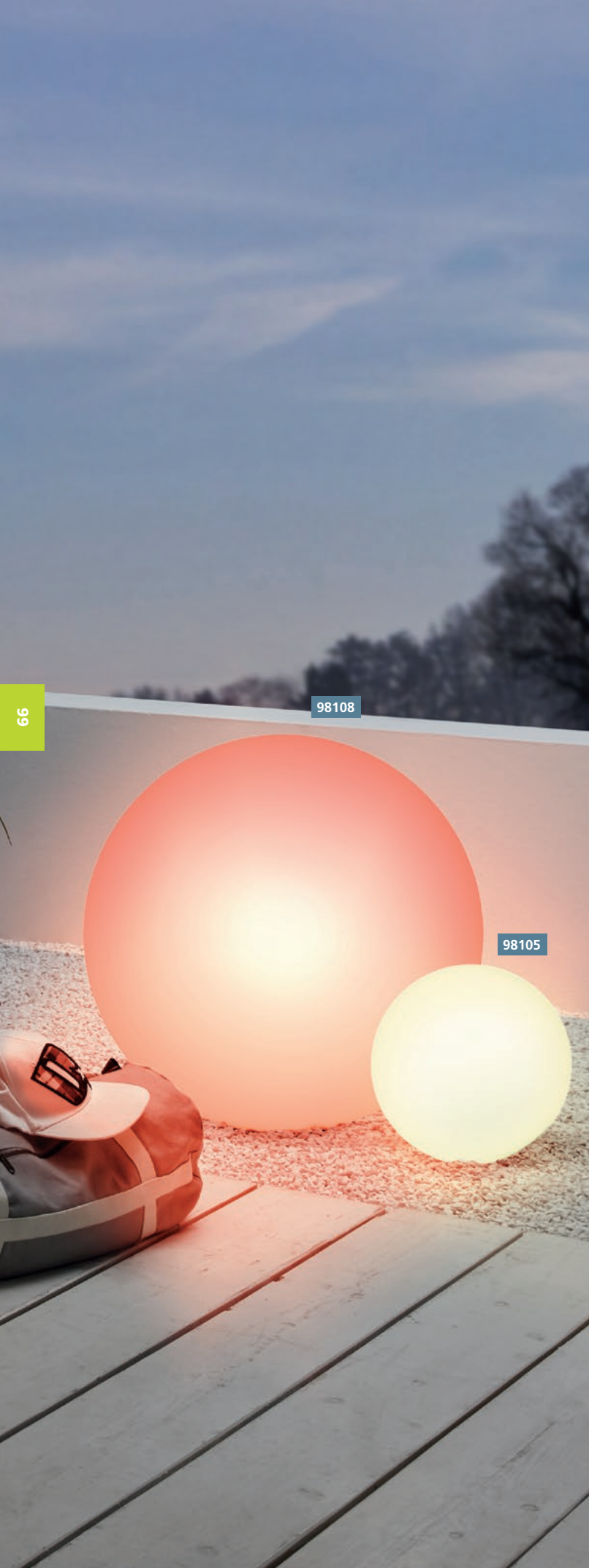



98105 MONTEROLO-C

floor luminaire; plastic, white / plastic, white
 Stehleuchte; Kunststoff, weiss / Kunststoff, weiss
 lampadaire; plastique, blanc / plastique, blanc

H 300, Ø 300, Base: Ø 120

-  E27
-  1x 9W
-  1x 806lm
-  2000
-  IP65

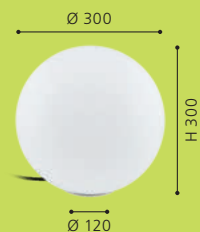



98107

LED



98106

LED



98108

LED

98106 MONTEROLO-C

floor luminaire; plastic, white / plastic, white
 Stehleuchte; Kunststoff, weiss / Kunststoff, weiss
 lampadaire; plastique, blanc / plastique, blanc

98107 MONTEROLO-C

floor luminaire; plastic, white / plastic, white
 Stehleuchte; Kunststoff, weiss / Kunststoff, weiss
 lampadaire; plastique, blanc / plastique, blanc

98108 MONTEROLO-C

floor luminaire; plastic, white / plastic, white
 Stehleuchte; Kunststoff, weiss / Kunststoff, weiss
 lampadaire; plastique, blanc / plastique, blanc

H 390, Ø 390, Base: Ø 195



H 500, Ø 500, Base: Ø 195



H 600, Ø 600, Base: Ø 195





88152, 88153

The above mentioned pictogram indicates suitable luminaires which can be easily mounted on corners with this accessories.

Das oben gezeigte Piktogramm markiert passende Leuchten, welche mit dem Zubehör einfach an Ecken montiert werden können.

Le pictogramme ci-dessus marque les luminaires correspondant, qui peut être monté avec les accessoires simples dans les coins.

88152

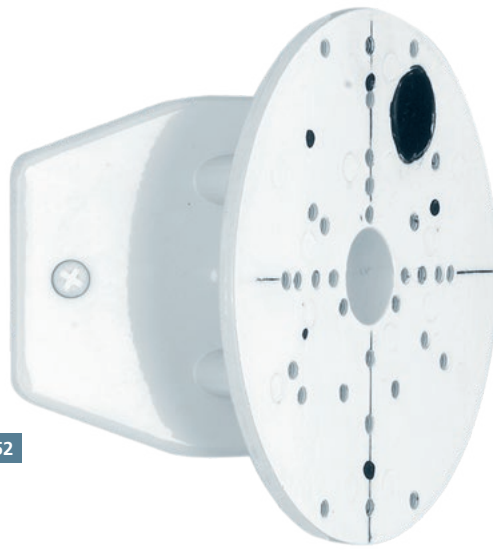

88153

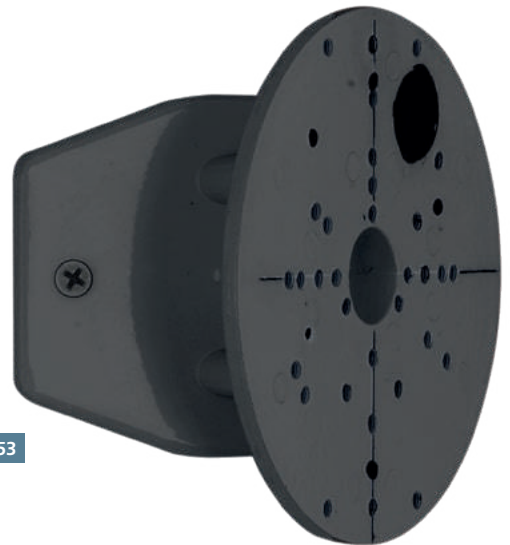

88152

accessory; steel, white
Zubehör; Stahl, weiss
accessoire; acier, blanc

H 50, Ø 112



9 002759 881528

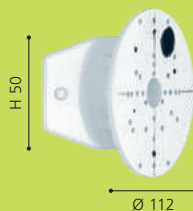

88153

accessory; steel, black
Zubehör; Stahl, schwarz
accessoire; acier, noir

H 50, Ø 112



9 002759 881535

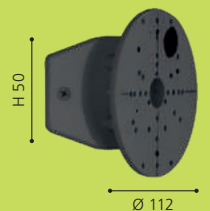

88153

97446



EGLO CONNECT ILLUMINANTS



OVERVIEW

EGLO CONNECT ILLUMINANTS



EGLO CONNECT
72



EGLO CONNECT
72



LM_LED_E14
72



EGLO CONNECT
73



LM_LED_GU10
73



LM_LED_E27
73

5 year warranty
Jahre Garantie
ans de garantie
anni di garanzia
años de garantía

A+

RGB+TW



11672 E14-LEDTW-P50

Dimensions Abmessungen / dimensions	L 90, Ø 50
Socket Sockel / douille	E14
Wattage Wattage / puissance	5W
Light Colour Lichtfarbe / couleur lumineuse	2700-6500K
Operating voltage Betriebsspannung / tension de fonctionnement	220-240V,50/60Hz
Switching cycles Schaltzyklen / cycles de fonctionnement	15.000 x
Operating hours Betriebsstunden / heures de fonctionnement	25.000 h
Colour rendering index Farbwiedergabeindex / L'indice de restitution de couleurs	>80

11586 E27-LEDTW-A60

Dimensions Abmessungen / dimensions	L 116, Ø 60
Socket Sockel / douille	E27
Wattage Wattage / puissance	9W
Light Colour Lichtfarbe / couleur lumineuse	2700-6500K
Operating voltage Betriebsspannung / tension de fonctionnement	220-240V,50/60Hz
Switching cycles Schaltzyklen / cycles de fonctionnement	15.000 x
Operating hours Betriebsstunden / heures de fonctionnement	25.000 h
Colour rendering index Farbwiedergabeindex / L'indice de restitution de couleurs	>80

9W

806 lm
LUMEN



5 year warranty
Jahre Garantie
ans de garantie
anni di garanzia
años de garantía

A+

RGB+TW



5 year warranty
Jahre Garantie
ans de garantie
anni di garanzia
años de garantía

A+

RGB+TW



11585 E27-LEDTW-A60

Dimensions Abmessungen / dimensions	L 116, Ø 60
Socket Sockel / douille	E27
Wattage Wattage / puissance	9W
Light Colour Lichtfarbe / couleur lumineuse	2700-6500K
Operating voltage Betriebsspannung / tension de fonctionnement	220-240V,50/60Hz
Switching cycles Schaltzyklen / cycles de fonctionnement	15.000 x
Operating hours Betriebsstunden / heures de fonctionnement	25.000 h
Colour rendering index Farbwiedergabeindex / L'indice de restitution de couleurs	>80

11659 E27-LEDTW-G95

Dimensions Abmessungen / dimensions	L 136, Ø 95
Socket Sockel / douille	E27
Wattage Wattage / puissance	13W
Light Colour Lichtfarbe / couleur lumineuse	2700- 6500K
Operating voltage Betriebsspannung / tension de fonctionnement	220-240V,50/60Hz
Switching cycles Schaltzyklen / cycles de fonctionnement	15.000 x
Operating hours Betriebsstunden / heures de fonctionnement	25.000 h
Colour rendering index Farbwiedergabeindex / L'indice de restitution de couleurs	>80

13W

1300 lm
LUMEN



5 year warranty
Jahre Garantie
ans de garantie
anni di garanzia
años de garantía

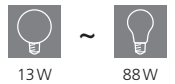

5 year warranty
Jahre Garantie
ans de garantie
anni di garanzia
años de garantía



11671 GU10-LEDTW

Dimensions Abmessungen / dimensions	L 68, Ø 50
Socket Sockel / douille	GU10
Wattage Wattage / puissance	5W
Light Colour Lichtfarbe / couleur lumineuse	2700- 6500K
Operating voltage Betriebsspannung / tension de fonctionnement	220-240V,50/60Hz
Switching cycles Schaltzyklen / cycles de fonctionnement	15.000 x
Operating hours Betriebsstunden / heures de fonctionnement	25.000 h
Colour rendering index Farbwiedergabeindex / L'indice de restitution de couleurs	>80
Beamangle Ausstrahlwinkel / angle de rayonnement	7°

73

11684 E27-LED-A60

Dimensions Abmessungen / dimensions	L 118, Ø 60
Socket Sockel / douille	E27
Wattage Wattage / puissance	9W
Light Colour Lichtfarbe / couleur lumineuse	3000K
Operating voltage Betriebsspannung / tension de fonctionnement	220-240V,50/60Hz
Switching cycles Schaltzyklen / cycles de fonctionnement	15.000 x
Operating hours Betriebsstunden / heures de fonctionnement	25.000 h
Colour rendering index Farbwiedergabeindex / L'indice de restitution de couleurs	>80

9W

806 lm
LUMEN



5 year warranty
Jahre Garantie
ans de garantie
anni di garanzia
años de garantía

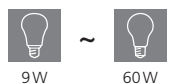

ENERGY EFFICIENCY LABELS

ENERGIEEFFIZIENZ-LABEL

LABEL DE L'EFFICACITÉ ÉNERGÉTIQUE

LED luminaires - are increasingly popular and the demand for energy-efficient solutions is gaining strength. This has resulted in the adoption of several EU regulations prescribing the energy efficiency labelling of light sources and luminaires. We have prepared a brief overview of the new energy labels.

LED Leuchtmittel - sind am Vormarsch, der Ruf nach energieeffizienten Lösungen wird immer größer. In den letzten Jahren wurden daher mehrere EU-Verordnungen verabschiedet, die die Kennzeichnung der Energieeffizienz bei Leuchtmitteln und Leuchten vorschreibt. Hier finden Sie eine kurze Übersicht der neuen Energieeffizienz-kennzeichnung.



Les éclairages LED - gagnent du terrain, la demande de solutions efficaces en énergie ne cesse de croître. C'est la raison pour laquelle plusieurs directives européennes prescrivant le marquage de l'efficacité énergétique des moyens d'éclairage et des lampes ont été promulguées au cours de ces dernières années. Vous trouverez ici un bref aperçu d'ensemble des nouveaux marquages de l'efficacité énergétique.

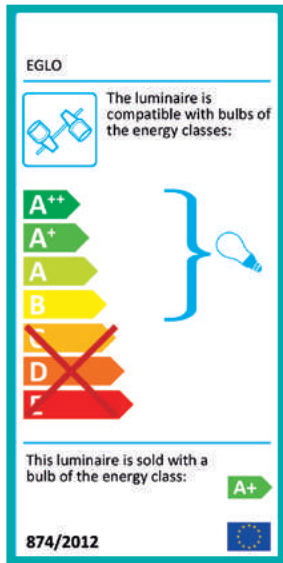

The information in brackets at the centre of the label indicates which bulbs may be used for the luminaire. In this case, the product is only compatible with bulbs with an energy efficiency rating of better than C.

Die Klammer in der Mitte des Labels gibt an, mit welchen Leuchtmitteln die Leuchte kompatibel ist. In diesem Fall dürfen nur Leuchtmittel verwendet werden, deren Energieklasse effizienter als C ist.

La parenthèse au milieu du label indique les moyens d'éclairage avec lesquels la lampe est compatible. Il est seulement permis dans ce cas d'utiliser des moyens d'éclairage dont la classe d'énergie présente une efficacité supérieure à C.

If bulbs are included with the luminaire, their energy classes are indicated at the bottom of the label.

Falls Leuchtmittel inkludiert sind, wird deren Energieklasse im unteren Teil des Labels angegeben.

Si des moyens d'éclairage sont inclus, leur classe énergétique est indiquée dans la partie inférieure du label.

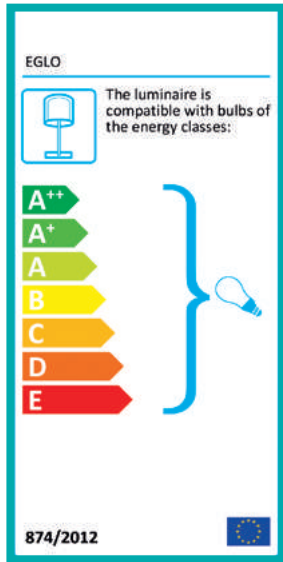

This label indicates that no bulbs are included with the luminaire. Consumers are free to choose their preferred bulb within the indicated energy classes.

Dieses Label wird verwendet, wenn die Leuchte ohne Leuchtmittel ausgeliefert wird. Der Kunde kann selber entscheiden, welches Leuchtmittel der angegebenen Klassen verwendet wird.

Ce label est utilisé lorsque la lampe est livrée sans ampoules. Le client peut décider lui-même quel ampoule des classes indiquées est utilisé.

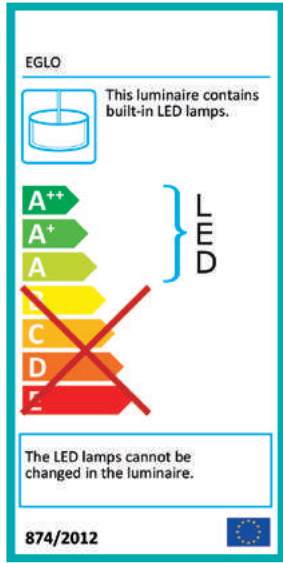

This label indicates that the luminaire is sold with built-in LED lamps that cannot be replaced by the consumer himself.

Dieses Label wird verwendet, wenn Leuchten mit LED-Modulen verkauft werden, die vom Endkunden nicht selbstständig ausgetauscht werden können.

Ce label est utilisé lorsque des lampes sont vendues avec des modules LED ne pouvant pas être changés par les clients finaux eux-mêmes.

EEL BUTTONS

bulbs included

inkl. Leuchtmittel | ampoules comprises



incl. highly efficient LED boards (cannot be replaced by the end consumer)

inkl. hocheffizienter LED Platinen (können nicht vom Endkonsumenten ausgetauscht werden)

incl. platines LED très efficaces (ne peuvent pas être remplacés par le consommateur final)



incl. highly efficient LED bulbs

inkl. hocheffizienter LED Leuchtmittel

ampoules à LED plus efficaces comprises



incl. efficient LED and/or fluorescent bulbs

inkl. effizienter LED und/oder Leuchtstoff-Leuchtmittel

ampoules à LED et/ou fluorescentes efficaces comprises



incl. halogen bulbs

inkl. Halogen-Leuchtmittel

ampoules halogènes comprises

bulbs not included

exkl. Leuchtmittel | ampoules non comprises



The luminaire is compatible with bulbs of all energy classes.

Die Leuchte ist mit Leuchtmitteln aller Energieklassen kompatibel.

compatible avec des ampoules de toutes les classes de l'énergie



The luminaire is only compatible with energy efficient bulbs.



















Die Leuchte ist nur mit energieeffizienten Leuchtmitteln kompatibel.

compatible uniquement avec des ampoules économes en énergie

























LEGEND

PICTOGRAM PIKTOGRAMME PICTOGRAMME

SOCKETS FASSUNGEN DOUILLES

 LED	 G4	 G53
 2G7	 G5	 GU5,3 / MR16
 2G11	 G9	 GU10
 2GX13	 G10Q	 GX53
 E14	 G13	 GY6,35
 E27	 G23	 R7s

BULBS LEUCHTMITTEL AMPOULES

 E14 / C35	 E27 / A60 Halogen	 E27 / E140 Filament
 E14 / C35f	 E27 / R63 Halogen	 E27 / PS160 Filament
 E14 / D45	 E27 / A60 LED	 E27 / T30 Filament
 E14 / C35f LED	 E27 / A60 Filament	 E27 / T32 Filament
 E14 / D45 Halogen	 E27 / A65 LED	 G4 / T9
 E14 / C35 Halogen	 E27 / A75 Filament	 G4 / LT9
 E14 / T22	 E27 / G45 LED	 G4 / LT14
 E14 / C35 Filament	 E27 / G45 Filament	 G9
 E14 / C37 Filament	 E27 / G80 Filament	 G9 LED
 E14 / C35f Filament	 E27 / G95	 GU10
 E14 / C37f Filament	 E27 / G95 Filament	 GU10 LED
 E14 / P45 LED	 E27 / G125	 GU10 SMD LED
 E14 / P45 Filament	 E27 / G95 LED	 GX53 / LF75
 E14 / P50	 E27 / G200 Filament	LED LED board / LED Platine / LED bord
 E14 / ST48 Filament	 E27 / R63 LED	 MR16
 E14 / ST64 Filament	 E27 / ST48 Filament	 MR16 LED
 E14 / T20 LED	 E27 / ST64 Filament	 R7s / 78mm
 E27 / A60	 E27 / B80 Filament	 R7s / 118mm
 E27 / G90	 E27 / BR150 Filament	 R7s / 78mm LED
 E27 / QR63	 E27 / DP165 Filament	 R7s / 118mm LED

LIGHT COLOUR & LUMEN
LICHTFARBE & LUMEN
COULEUR LUMINEUX & LUMEN

The colours of the LED are represented as pictogrammes (see below), their luminous flux directly beneath. The luminous flux is quoted in lumen and describes the amount of light generated by the LED. The higher the value, the brighter is the lamp. Lumens are LED boards and are the light measurement value in bulbs.

Die Farben der LED werden als Piktogramm (siehe unten) dargestellt, deren Lichtstrom direkt darunter. Der Lichtstrom wird in Lumen gemessen und gibt die erzeugte Lichtmenge der LED an. Je höher der Wert, desto heller das Produkt. Lichtstromangaben (Lumen) sind Platinen- bzw. Leuchtmittelwerte.

Les couleurs de LED ont représentés sous forme de pictogrammes, leur flux lumineux directement en dessous. L'unité de flux lumineux est le lumen et il mesure la quantité de lumière générée par les LED. Plus la valeur est élevée, plus la lampe est lumineuse. Les lumens sont l'unité de mesure de l'intensité lumineuse des ampoules et des panneaux led intégrés.

	RGB RGB RGB		RGB + tunable white RGB + tunable white RGB + tunable white
	RGB + white RGB + weiß RGB + blanc		tunable white tunable white tunable white
	RGB + warmwhite RGB + warmweiß RGB + blanc chaud		warm white warmweiß blanc chaud
	RGB + coldwhite RGB + kaltweiß RGB + blanc froid		cold white kaltweiß blanc froid
	RGB + neutralwhite RGB + neutralweiß RGB + blanc neutral		neutral white neutralweiß blanc neutre

SWITCHES & SENSORES
SCHALTER & SENSOREN
INTERRUPTEUR & CAPTEURS

	incl. cable & plug inkl. Kabel & Stecker câble & connecteur inclus		pedal switch Trittschalter interrupteur à pied		swedish plug Stecker Schweden connecteur swede
	internal dimmer eingebauter Dimmer variateur intégré		cable switch Kabelschalter interrupteur à câble		"Touch me" ON/OFF "Touch me" EIN/AUS "Touch me" ON/OFF
	button switch Druckknopf interrupteur de pression		incl. cable & plug transformer inkl. Kabel & Stecktransformator câble & transformateur à prise		"Touch me" ON/OFF & dimm "Touch me" EIN/AUS & Dimmen "Touch me" ON/OFF & graduable
	function switch Funktionsschalter interrupteur fonction		remote control Fernbedienung télécommande		pull switch Zugschalter interrupteur à bascule
	rocker switch Wippschalter interrupteur à bascule		Day & Night Sensor Tag & Nacht Sensor sensor jour & nuit		Timer - automatic on/off Zeitschaltuhr - automatisches Ein- & Ausschalten minuterie - peut être éteint et allumé automatiquement
	pedal dimmer Trittdimmer variateur à pied		sensor Sensor sensor		

FUNKTIONEN & KOMFORT
FUNKTIONEN & KOMFORT
FONCTIONS & CONFORT

	incl. battery inkl. Akku incl. pile		cutout (in mm) Ausschnitt (in mm) perçage du panneau (en mm)		shortable kürzbar réductible
	incl. battery inkl. Batterie incl. pile		dimmmable dimmmbar graduabile		Voltage Volt Voltage
	battery specifications Batteriespezifikationen spécifications des piles		not dimmmable nicht dimmmbar ne pas graduabile		Watt
	beam angle Ausstrahlwinkel angle de rayonnement		replaceable LED austauschbare LED LED remplaçables		
	corner mount possible Eckmontage möglich montage en coin possible		loadable in kg belastbar in kg chargeable en kg		
	Colour Rendering Index		packaging / delivery unit Verpackungs- / Liefereinheit unité d'emballage / de livraison		

PROTECTION CLASS
SCHUTZKLASSE
CLASSE DE PROTECTION

The protection class indicates to what extent the lamp is protected against electric shock. All lamps in this catalogue are at least protected with the protection class 1 - a higher class is specified in the information box of the respective lamp.

Die Schutzklasse gibt an, inwiefern ein Produkt gegen einen elektrischen Schlag gesichert ist. Alle Leuchten in diesem Katalog sind mit mindestens Schutzklasse 1 gesichert, bei höheren Klassen wird das Symbol im Infokasten der Leuchte angegeben.

La classe de protection indique, dans quelle mesure la lampe est protégée contre les chocs électriques. Tous les lampes dans ce catalogue sont protégées au moins avec la classe 1 - une classe plus élevée est indiquée dans l'information de la lampe.

	protection class 1: protective earthing Schutzklasse 1: Schutzerdung classe de protection 1: prise de terre		protection class 2: protective insulation Schutzklasse 2: Schutzisolation classe de protection 2: double isolation ou renforcée		protection class 3: protective low voltage Schutzklasse 3: Schutzkleinspannung classe de protection 3: très basse tension de sécurité
--	-------------------------------------------------------------------------------------------------------------------	--	---------------------------------------------------------------------------------------------------------------------------------------	--	---------------------------------------------------------------------------------------------------------------------------------------------

PROTECTION RATING
SCHUTZGRAD
INDICE DE PROTECTION

The protection rating ensures the operational safety of luminaires. The first number specifies the extent of the protection against the ingress of foreign bodies; the second number identifies the humidity protection grade. All luminaires in this catalogue are at least protected with the rating IP20 - a higher rating is specified in the information box of the luminaire.

Der Schutzgrad gewährleistet die Betriebssicherheit von Leuchten. Die erste Ziffer des IP Grades beschreibt den Schutzzumfang gegen das Eindringen von Fremdkörpern, die zweite Ziffer informiert über den Grad des Feuchtigkeitsschutzes. Alle Leuchten in diesem Katalog sind mit mindestens Schutzgrad IP20 gesichert, bei höheren Graden wird das Symbol im Infokasten der Leuchte angegeben.

L'indice de protection assure la sécurité opérationnelle des luminaires. Le premier chiffre indique à quel point la protection est efficace contre l'insertion de corps étrangers; le second chiffre indique quant à lui le degré de protection par rapport à l'humidité. Tous les luminaires dans ce catalogue sont protégés au moins avec l'indice IP20 - un indice plus élevé est indiqué dans l'information d'article.

	IP33		IP44		IP54		IP65		IP67
--	------	--	------	--	------	--	------	--	------

REGISTER

SERIES NAMES
SERIENNAMEN
NOME DE PRODUITS

NAME NAME NOME	PAGE PRODUCT SEITE PRODUKT PAGE PRODUIT
ARGOLIS-C	54-55
CALDIERO-C	60-61
CAPASSO-C	26-27
CERIGNOLA-C	23
COMBA-C	19
COMPETA-C	26
CONNECT PLUG	11
CONNECT PLUG PLUS	11
CONNECT REMOTE	10
CONNECT SENSOR	52
CORROPOLI-C	30-31
EGLO CONNECT	72-73
FRAIOLI-C	14-15
FRANCARI-C	59

NAME NAME NOME	PAGE PRODUCT SEITE PRODUKT PAGE PRODUIT
FRATTINA-C	16-17
FUEVA-C	36-43,48-49
GIRON-C	26
HORNITOS-C	23
LM_LED_E14	72
LM_LED_E27	73
LM_LED_GU10	73
LOCANA-C	57
MARCHESA-C	59
MONEVA-C	20-21
MONTEROLO-C	66-67
NEMA 1-C	65
NISIA-C	62
OPTICA-C	18

NAME NAME NOME	PAGE PRODUCT SEITE PRODUKT PAGE PRODUIT
PALOMBARE-C	28-29
PIOVE-C	57
RIODEVA-C	19
SALOBRENA-C	34-35
SARSINA-C	32-33
STRIPE-C	44
TABIANO-C	49
TABRIZ-C	12
TORAZZA-C	58
TOTARI-C	24-25
VERLUCCA-C	65
VERRES-C	59
VOLTAGO-C	24

REGISTER

ARTIKEL NUMBER
ARTIKELNUMMER
NUMÉROS D'ARTICLE

NUMBER NUMMER NUMÉRO	PAGE PRODUCT SEITE PRODUKT PAGE PRODUIT
11585	72
11586	72
11659	73
11671	73
11672	72
11684	73
32589	26
32732	10
32733	44
32737	36
32738	36
32741	44
32753	38
32754	38
32881	36
32882	38
88152	68
88153	68
96662	34
96663	34
96664	35
96668	37
96669	40
96671	40
96672	41
96673	41
96676	39
96677	42
96678	42
96679	43
96681	43
96684	24
96686	27
96818	26
96821	26
97219	58

NUMBER NUMMER NUMÉRO	PAGE PRODUCT SEITE PRODUKT PAGE PRODUIT
97237	57
97239	59
97247	62
97248	62
97249	62
97295	57
97299	57
97446	65
97447	65
97475	52
97476	11
97482	60
97483	61
97484	61
97485	61
97629	34
97691	29
97692	28
97693	28
97694	28
97714	31
97715	30
97716	30
97717	30
97811	16
97812	16
97813	16
97814	17
97906	14
97907	14
97908	15
97909	15
97911	14
97918	24
97921	24
97922	25

NUMBER NUMMER NUMÉRO	PAGE PRODUCT SEITE PRODUKT PAGE PRODUIT
97936	11
97958	32
97959	32
97961	32
98041	20
98042	20
98043	20
98044	21
98045	19
98046	19
98047	19
98052	65
98089	35
98105	66
98106	67
98107	67
98108	67
98145	59
98171	54
98172	54
98173	54
98174	55
98234	59
98371	18
98372	18
98427	23
98451	49
98452	49
98459	25
98468	12
98469	12
98559	48
98561	49
98566	33
98605	23
98606	23

All previous catalogues and price lists are no longer valid with the issue of this catalogue. Errors, misprints, model and price changes and technical modifications are reserved. We deliver based on our terms of delivery and payment. Our products comply with the European light norm EN60598. Products with the ENEC test mark are conforming to the guide line 2006/95/EG. Products with additional safety remarks (e.g protection class, IP) are identified within the product family with the relevant symbol and number. The content of this catalogue is protected under copyright law for EGLO Leuchten GmbH. All rights reserved. Our specific written consent must be obtained before using any illustrations and texts. The pictures are 4C prints and may differ from the original.

The product pictures and ambiances in this catalogue can deviate from reality, and they do not necessarily concur with the usual application of the product. EGLO does not assume liability for the correctness, completeness or the application depiction of the products and/or the product information.

Design, layout and composition: EGLO GmbH, A-6136 Pill - AUSTRIA, Mariacher & Friends Werbeagentur GmbH, A6130 Schwaz

Print: Samson Druck GmbH, 5581 St. Margarethen

Pictures: EGLO, Adobe Stock, istockphoto.com, Shutterstock

Mit diesem Katalog verlieren alle vorhergehenden Kataloge und Preislisten ihre Gültigkeit. Irrtümer, Druckfehler, Modell- und Preisänderungen sowie technische Änderungen vorbehalten. Wir liefern zu unseren Liefer- und Zahlungsbedingungen. Unsere Produkte entsprechen der europäischen Leuchtnorm EN 60598. Produkte mit dem ENEC Prüfzeichen sind konform mit der Richtlinie 2006/95/EG. Produkte mit weiteren Sicherheitshinweisen (zB. Schutzklasse, IP) sind mit Symbol und Zahl bei der Produktfamilie ausgezeichnet. Der Inhalt dieses Kataloges ist für die EGLO Leuchten GmbH urheberrechtlich geschützt. Alle Rechte sind vorbehalten. Bilder und Texte dürfen nicht ohne vorherige ausdrückliche, schriftliche Genehmigung verwendet werden. Die Abbildungen sind 4C Drucke und können vom Original abweichen.

Die Katalogbilder und die gezeigten Darstellungen der Produkte können von der Wirklichkeit abweichen und nicht den üblichen Produktanwendungen entsprechen. EGLO übernimmt keine Haftung für die Richtigkeit, Vollständigkeit und Anwendungsdarstellung der Produkte und Produktinformationen.

Gestaltung, Layout und Satz: EGLO GmbH, A-6136 Pill - AUSTRIA, Mariacher & Friends Werbeagentur GmbH, A6130 Schwaz

Druck: Samson Druck GmbH, 5581 St. Margarethen

Bilder: EGLO, Adobe Stock, istockphoto.com, Shutterstock

Le présent catalogue remplace tous les catalogues et tarifs précédents. Sous réserve d'erreurs, de fautes d'impression, de modification des modèles et de changement de prix et de technique. Nous livrons sur la base de nos conditions de livraison et de paiement. Nos produits sont conformes aux normes européennes EN 60598 et portent le marquage CE. Les produits portant la marque ENEC sont conformes à la Directive 2006/95/EG. Les produits portant d'autres indications de sécurité (par exemple classe de protection, IP) sont identifiés par le symbole et le nombre correspondants dans la famille de produits.

Le contenu du présent catalogue est protégé pour la société EGLO Leuchten GmbH par un copyright. Tous droits réservés. Toute reproduction d'images et du texte est interdite sans autorisation explicite par écrit préalable. Les images sont imprimées en 4C et peuvent différer de l'original.

Les images des produits et les ambiances dans le catalogue peuvent dévier de la réalité et ne sont pas nécessairement en ligne avec l'usage habituel du produit. EGLO n'engage pas sa responsabilité sur la justesse des images et sur les informations relatives à l'usage pouvant être fait des produits.

Conception, maquette et composition: EGLO GmbH, A-6136 Pill - AUSTRIA, Mariacher & Friends Werbeagentur GmbH, A6130 Schwaz

Presse: Samson Druck GmbH, 5581 St. Margarethen

Images: EGLO, Adobe Stock, istockphoto.com, Shutterstock

08-2019



EGLO Leuchten GmbH
Heiligkreuz 22
A-6136 Pill
Austria
Tel. +43 (0) 5242 6996
Fax +43 (0) 5242 6996-972
info@eglo.com
www.eglo.com

my light | my style