



EGLO
my light | my style



2020/21

OUTDOOR LUMINAIRES

AUSSENLEUCHTEN
LUMINAIRES EXTÉRIEURS



Dear customers and business partners,
our loyal EGLO friends,

We offer you the perfect lighting for your garden, your terrace and balcony. Our assortment of outdoor luminaires ranges from classic, to traditional, modern and extravagant luminaires.

However, outdoor luminaires are not only useful for aesthetic reasons but also provide the necessary security around your home, especially in the dark autumn and winter months. With our Safety & Comfort luminaires, which are all equipped with motion sensors, you can keep uninvited visitors away.

Our Smart Light Bluetooth System "connect" is also an important part of our innovative outdoor lamp range.

Have fun browsing
our catalogue!

Geschätzte Kunden und Geschäfts-
partner, treue EGLO-Freunde,

Wir bieten Ihnen die perfekte Beleuchtung für Ihren Garten, Ihre Terrasse oder Ihren Balkon. Unser Sortiment an Außenleuchten reicht von klassischen bis hin zu modernen, extravaganten und traditionellen Leuchten.

Außenleuchten sind aber nicht nur aus ästhetischen Gründen sinnvoll, sondern sorgen vor allem in den dunklen Herbst- und traditionellen Wintermonaten für die nötige Sicherheit rund um Ihr zu Hause. Mit unseren Leuchten der Linie Safety & Comfort, die alle über Bewegungssensoren verfügen, halten Sie ungebetene Besucher fern.

Auch weiterhin ist unser Smart Light Bluetooth System „connect“ wichtiger Bestandteil unseres innovativen Außenleuchtensortiments.

Viel Vergnügen beim Durchstöbern
unseres Kataloges!

Chers clients, chers partenaires com-
merciaux, chers amis d'EGLO,

Nous vous proposons l'éclairage parfait pour le jardin, la terrasse ou le balcon. Notre palette d'éclairages extérieurs s'étend des modèles classiques et traditionnels aux éclairages modernes et extravagants.

Cependant, les luminaires extérieurs ne sont pas seulement utiles pour des raisons esthétiques, mais également pour assurer la sécurité nécessaire autour de votre maison, en particulier pendant les mois sombres d'automne et d'hiver. Avec nos luminaires Safety & Comfort, tous équipés de capteurs de mouvement, vous pouvez éloigner les visiteurs indésirables.

Notre système Bluetooth de lumière intelligente « connect » est un élément important de notre gamme innovante de luminaires extérieurs.

Nous vous souhaitons beaucoup de plaisir en feuilletant notre catalogue !



CONTENTS

INHALT
CONTENU



EGLO CONNECT

4-27



TOPLINE

108-119



SAFETY & COMFORT

28-37



CLASSIC

KLASSIK
CLASSIQUE

120-163



MODERN

MODERN
MODERNE

38-107



SPOTS, RECESSED & ACCESSOIRES

SPOTS, EINBAULEUCHTEN & ZUBEHÖR
SPOTS, LUMINAIRES ENCASTRÉS & ACCESSOIRES

164-193



GARDEN LIVING

194-197



INDEX & LEGEND

198-208

INDEX & ERKLÄRUNG
INDEX & LÉGENDE

EI	198-199
EGLO WORLDWIDE	200-201
LEGEND	202-205
REGISTER	206-209
MEMO	210-215
IMPRESSUM	216

Light takes a
new direction:
Your direction



EGLO CONNECT

OVERVIEW

EGLO CONNECT



EGLO CONNECT
15



CONNECT REMOTE
16



CONNECT SENSOR
16



PIOVE-C
16



LOCANA-C
16



LOCANA-C
16



ARGOLIS-C
17



ARGOLIS-C
17



ARGOLIS-C
17



ARGOLIS-C
17



TORAZZA-C
18



FRANCARI-C
19



MARCHESA-C
19



LM_LED_E27
20



VERRES-C
20



CALDIERO-C
21



CALDIERO-C
21



CALDIERO-C
21



CALDIERO-C
21



NISIA-C
22



NISIA-C
22



NISIA-C
22



MONTEROLO-C
24



MONTEROLO-C
24



MONTEROLO-C
24



EGLO CONNECT
24



MONTEROLO-C
25



LM_LED_GU10
25



NEMA 1-C
25



LM_LED_E27
26



LM_LED_E27
26



LM_LED_E27
26



1



Luminaire / Bulb
Leuchte / Leuchtmittel
Luminaire / Ampoules

2



Remote Control / App
Fernbedienung / App
Télécommande / App



3

LET'S GO!!!

EASY, SMART & SAFE

EINFACH, INTELLIGENT & SICHER
SIMPLE, INTELLIGENT ET SÛR

If you're looking for easy installation and uncomplicated devices, EGLO connect is the right place for you.

Suchst du leichte Installationen und unkomplizierte Geräte - dann bist du bei EGLO connect genau richtig.

Des installations aisées et des appareils simples – EGLO connect est le bon dispositif pour toi.

Starting is made quick and easy, you only need two components:

Der Einstieg ist schnell und einfach, du benötigst nur zwei Komponenten:

Les premiers pas sont simples et rapides, tu as besoin de deux objets :

- › An EGLO connect luminaire / illuminant
- › An EGLO connect remote control or the free AwoX Smart control App

- › Eine EGLO connect Leuchte / Leuchtmittel
- › Eine EGLO connect Fernbedienung oder die kostenlose AwoX Smart control App

- › Une lampe / ampoule EGLO connect
- › Une télécommande EGLO connect ou l'application gratuite AwoX Smart control

You'll be set to start immediately then!

Schon kann's losgehen!

Prêt à te lancer!

The system's basic advantages are:

Die grundlegenden Vorteile des Systems sind:

Les avantages primordiaux du système sont:



Simple installation

EGLO connect products use Bluetooth technology and do not need any elaborate installations.

Einfache Installation

EGLO connect Produkte verwenden die Bluetooth Technologie und benötigen keine aufwändigen Installationen.

Une installation simple

Les produits EGLO connect emploient la technologie Bluetooth et ne nécessitent pas d'installations complexes.



Smart technology

The EGLO connect items communicate with each other to form a smart, expandable network (MESH technology).

Smarte Technologie

Die EGLO connect Artikel kommunizieren miteinander und bilden ein intelligentes, erweiterbares Netzwerk (MESH-Technologie).

Une technologie intelligente

Les articles EGLO connect communiquent les uns avec les autres et forment un réseau intelligent et extensible (technologie MESH).



Protected network

All EGLO connect products in your home form a closed network and are secured against third-party access.

Geschütztes Netzwerk

Alle EGLO connect Produkte in deinem Zuhause bilden ein geschlossenes Netzwerk und sind vor fremdem Zugriff gesichert.

Un réseau protégé

Tous les produits EGLO connect dans ton foyer forment un réseau fermé et sont ainsi protégés des accès étrangers.

GROWS & LEARNS

WÄCHST & LERNT
APPRENDRE ET ÉVOLUER

EGLO connect grows to match your needs:

BASIC USER:

Use the EGLO connect remote control together with the EGLO connect lamps / luminaires to adjust brightness, colours and mood. These functions are practical, easy to handle and will meet your daily needs.

ADVANCED USER:

Use the App and expand your options: Combine garden areas into groups to control lighting and other devices practically and quickly. Add to the experience of a movie night with the matching light scenario.

POWER USER:

Use the full potential of EGLO connect and the PLUG PLUS: Away from-Home control by integration in your WiFi, control by speech commands via Amazon Echo and Google Home, Day & Night function including motion detection and much more – the future of lighting in your home.

EGLO connect wächst mit deinen Bedürfnissen:

BASIC USER:

Du nutzt die EGLO connect Fernbedienung zusammen mit den EGLO connect Leuchtmitteln / Leuchten. Damit stellst du Helligkeit, Farbe und Stimmung ein. Diese Funktionen sind praktisch, einfach zu handhaben und genügen deinen täglichen Bedürfnissen.

ADVANCED USER:

Du nutzt die App und erweiterst deinen Spielraum: Fasse Gartenbereiche zu Gruppen zusammen, um Licht und andere Geräte praktisch und schnell anzu steuern zu können. Verstärke das Erlebnis eines Grillabends mit dem passenden Lichtszenario.

POWER USER:

Du nutzt das volle Potential von EGLO connect und dem PLUG PLUS. Away from-Home control durch Intergration in dein W-Lan, Steuerung per Sprachbefehl mit Hilfe von Amazon Echo und Google Home, Day & Night Funktion inklusive Bewegungserkennung und vieles mehr – Lichtzukunft in deinem Heim.

EGLO connect évolue avec tes besoins:

UTILISATEUR DE BASE:

Tu utilises la télécommande EGLO connect conjointement avec les ampoules/luminaires EGLO connect. Tu régles ainsi la luminosité, la couleur et l'ambiance. Ces fonctions sont pratiques, faciles à manier et suffisent à tes besoins au quotidien.

UTILISATEUR AVANCÉ:

Tu utilises l'application et accrois ta marge de manoeuvre : tu rassembles des zones de jardins en des groupes afin de pouvoir commander la lumière et les autres appareils de manière rapide et pratique. Renforces l'ambiance d'une soirée barbecue par la scénérie lumineuse correspondante.

UTILISATEUR PUISSANT:

Tu utilises l'ensemble du potentiel d'EGLO connect et PLUG PLUS. Un contrôle hors de chez toi par l'intégration dans ton Wi-Fi, un pilotage par commande vocale avec Amazon Echo et Google Home, une fonction jour & nuit avec détection de mouvements et bien d'autres choses - l'avenir de l'éclairage dans ta maison.

BASIC USER

No WLAN / internet necessary.
Controllable via a remote control.

Kein Wlan / Internet notwendig.
Steuerbar mit Fernbedienung.

Pas de Wifi / Internet nécessaire.
Commandable par télécommande.

BASIC USER EQUIPMENT



ADVANCED USER

Internet connection only needed for the installation of the app, registration and updates.

Controllable via smartphone / tablet (app) and remote control.

Integration of a battery-operated sensor with Day & Night function and motion detection possible.

Internetverbindung wird nur zur App Installation, Registrierung und für Updates benötigt.

Steuerbar mit Smartphone / Tablet (App) und Fernbedienung.

Einbindung eines batteriebetriebenen Sensors mit Day & Night Funktion und Bewegungserkennung möglich.

Connexion Internet requise uniquement pour l'installation de l'appli, l'enregistrement et les mises à jour.

Commandable avec Smartphone / Tablette (appli) et télécommande.

Intégration d'un capteur à batteries avec fonction « Jour et nuit » et détection de mouvement possible.

ADVANCED USER EQUIPMENT



POWER USER

You use the full potential of EGLO connect.

The PLUG PLUS allows Alexa, Google Home and your smartphone / tablet to control the system from home or on the road.

Du nutzt das volle Potential von EGLO connect.

Der PLUG PLUS ermöglicht es mithilfe von Alexa, Google Home und deinem Smartphone/Tablet das System von Zuhause oder unterwegs zu steuern.

Vous utilisez tout le potentiel d'EGLO connect.

Le connecteur PLUS permet à Alexa, Google Home et votre Smartphone / Tablette, de commander le système connect de chez vous ou à distance.

POWER USER EQUIPMENT

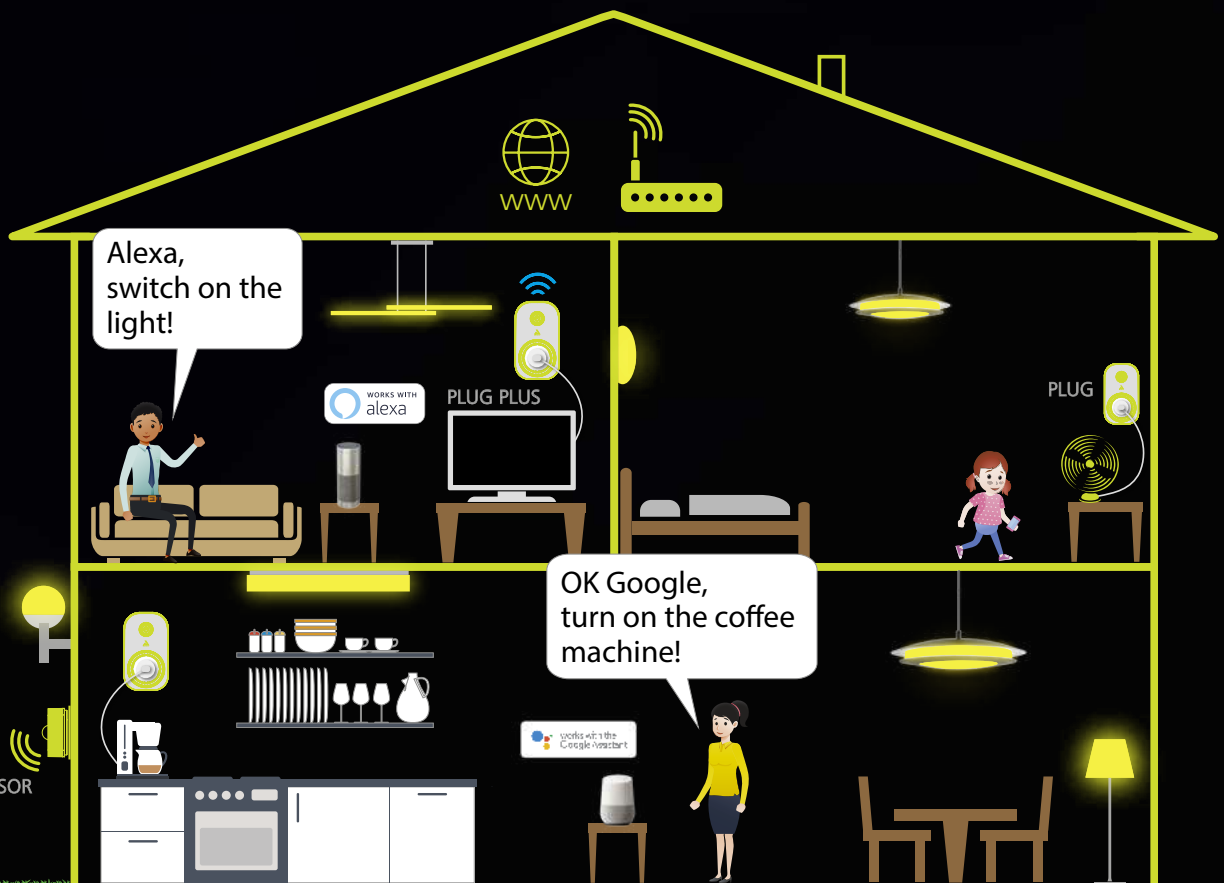



FUNCTION & CONTROL

FUNKTION & BEDIENUNG
FONCTION ET COMMANDE



Connect Sensor
Connect Sensor
Capteur Connect



Remote control
Fernbedienung
Télécommande



App control
App
App



CONNECT
PLUG



CONNECT
PLUG PLUS



Functions
Funktionen
Fonctions

Basic functions / Grundfunktionen / Fonctions de base

Activation / deactivation Ein- / Ausschalten Allumer / éteindre		•	•	•	•
Motion sensor Bewegungssensor Capteur de mouvements	•				
Light colour regulation Lichtfarben regulieren Réguler les teintes lumineuses		16,7 Mio.	16,7 Mio.		16,7 Mio.
Smooth dimming* Stufenloses Dimmen* Graduation continue*		•	•		
Voice control Sprachsteuerung Commande par la voix			(Siri shortcuts)		•

Comfort functions / Komfortfunktionen / Fonctions confort

Pre-set scenarios Voreingestellte Szenarien Scéneries prédéfinies			•		
Saving favourites Favoriten speichern Sauvegarder les favoris		2	4		
Grouping lamps Leuchten gruppieren Regroupement des luminaires			•		
Programming function (on / off) Programmierfunktion (Ein / Aus) Fonction de programmation (marche / arrêt)			•	•	•
Dawn simulation Dämmerungssimulation Simulation de crépuscule			•		
Timer function Timer-Funktion Fonction de minuterie			•	•	•
Day & night function Tag & Nacht-Funktion Fonction jour & nuit	•				
Night light Nachtlicht Veilleuse de nuit			•		
Names & pictures for luminaires Namen & Bilder für Leuchten Noms et photos pour les luminaires			•		
Disco function Diskofunktion Fonction disco			•		
BLE Smart Meter function BLE Smart Meter Funktion BLE Fonction smart meter				•	•

* for EGLO connect luminaires / bulbs only - nur für EGLO connect Leuchten / Leuchtmittel - seulement pour luminaires / ampoules EGLO connect



ADVANTAGES OF THE CONNECT SENSOR

IP44 Safety no cabling necessary

The CONNECT SENSOR is battery-operated, so that no difficult cabling is necessary. The sensor can be mounted directly on the wall. With the mounting bracket (included in the delivery), you can easily adjust the detection range to your needs. This permits fine adjustment by 30 degrees to the left and right.

Night mode

When Night mode is enabled the luminaires receive the indication night or day from the CONNECT SENSOR. Choose from 3 sensitivity settings (25 to 75%).

Night movement detection

When Night movement detection is enabled the CONNECT SENSOR turns on the luminaires with the chosen light intensity when movement is detected. You can choose from 3 movement detection sensitivity settings. The light will turn off after the selected time when no movement is detected.

Combination of Night mode and Night movement detection

VORTEILE DES CONNECT SENSOR

IP44 Schutz Keine Verkabelung notwendig

Der CONNECT SENSOR ist batteriebetrieben, so dass keine schwierige Verkabelung erforderlich ist. Der Sensor kann direkt an die Wand montiert werden. Mit der Montagehalterung (im Lieferumfang enthalten) können Sie den Erfassungsbereich ganz einfach an Ihre Bedürfnisse anpassen. Dadurch ist eine Feinjustierung von 30 Grad nach links und rechts möglich.

Nachtmodus

Wenn der Nachtmodus aktiviert ist, erhalten die Leuchten die Anzeige Nacht oder Tag vom CONNECT SENSOR. Wählen Sie aus 3 Empfindlichkeitseinstellungen (25 bis 75%).

Nachtbewegungserkennung

Wenn die Nachtbewegungserkennung aktiviert ist, schaltet der CONNECT SENSOR die Leuchten mit der gewählten Lichtintensität ein, wenn die Bewegung erkannt wird. Sie können aus 3 Bewegungserkennungssensitivitätseinstellungen wählen. Das Licht schaltet sich nach der gewählten Zeit aus, wenn keine Bewegung erkannt wird.

Kombination von Night mode und Night movement detection

ADVANTAGES DE LA CAPTEUR CONNECT

Protection IP44 Aucun câble nécessaire

Le CONNECT SENSOR est alimenté par batterie, donc aucun câblage difficile n'est nécessaire. Avec le support de montage (inclus dans la livraison), vous pouvez facilement ajuster l'étendue de la détection à vos besoins. Ce réglage fin de 30 degrés à gauche et à droite est possible.

Mode de nuit (Night mode)

Lorsque le mode de nuit est activé, les luminaires reçoivent l'indication du jour ou de la nuit du capteur CONNECT. Choisissez parmi 3 réglages de sensibilité (de 25 à 75%).

Détection de mouvement nocturne

Lorsque la détection de mouvement nocturne est activée, le CONNECT SENSOR allume les luminaires avec l'intensité lumineuse choisie lorsqu'un mouvement est détecté. Vous pouvez choisir parmi 3 réglages de sensibilité de détection de mouvement. Si aucun mouvement n'est détecté, la lumière s'éteindra après la période sélectionnée.

Combinaison du mode de nuit et de la détection de mouvement nocturne



11585 EGLO CONNECT

Bulb; plastic
Leuchtmittel; Kunststoff
Ampoule; plastique

L 118, Ø 60

E27	1x 9W	RGB-TW 2700-6500K	25000h	CONTROL UNIT Remote, App
220-240V, 50/60Hz	15000x	CRI >80		



A+



EGLO CONNECT ILLUMINANT

One illuminant – numerous possibilities: 16.7 million colours and over 50,000 white tones ensure the right atmosphere in your home at all times. The illuminant can be controlled via remote control or app using Bluetooth technology: You can control the brightness or adjust colour tones – and all this without complicated installation and comfortably from the sofa.

But the illuminant can do much more: it can be expanded at will using intelligent mesh technology, and up to 50 illuminants can be grouped together. This makes it easy to create and program a wide variety of lighting scenarios. You can also use the app to select from a large number of pre-set lighting scenes.

Security is not neglected either, as the illuminants form a self-contained network and are therefore protected from external access.

EGLO CONNECT LEUCHTMITTEL

Ein Leuchtmittel – zahlreiche Möglichkeiten: 16,7 Millionen Farben und über 50.000 Weißtöne sorgen jederzeit für die richtige Stimmung in Ihrem Heim. Über die Bluetooth-Technologie kann das Leuchtmittel per Fernbedienung oder App gesteuert werden: Sie können die Helligkeit kontrollieren oder Farbtöne einstellen – und das alles ohne aufwändige Installation und bequem vom Sofa aus.

Aber das Leuchtmittel kann noch viel mehr: es lässt sich per intelligenter Mesh-Technologie beliebig erweitern, bis zu 50 Leuchtmittel sind hierbei gruppierbar. So lassen sich problemlos und einfach unterschiedlichste Lichtszenarien erstellen und programmieren. Mit der App können Sie aber auch aus einer Vielzahl vorgegebener Lichtstimmungen auswählen.

Auch die Sicherheit kommt nicht zu kurz, denn die Leuchtmittel bilden ein in sich geschlossenes Netzwerk und sind somit vor Zugriffen von Außen geschützt.

AMPOULE EGLO CONNECT

Une seule ampoule – de nombreuses possibilités : 16,7 millions de couleurs et plus de 50 000 tons de blanc assurent à tout moment la bonne ambiance dans votre maison. L'ampoule peut être commandée via une télécommande ou une appli, utilisant la technologie Bluetooth : Vous pouvez contrôler la luminosité ou régler les tons de couleurs – et tout cela sans installation compliquée et de manière confortablement depuis votre canapé.

Mais l'ampoule peut faire beaucoup plus : elle peut être étendue à volonté grâce à la technologie Mesh intelligentes, et jusqu'à 50 ampoules peuvent être regroupées. Il est ainsi facile de créer et de programmer une grande variété de scène lumineuse. Vous pouvez également utiliser l'appli pour sélectionner un grand nombre d'ambiance lumineuse prédéfinies.

La sécurité n'est pas négligée non plus, car les ampoules forment un réseau fermé et sont donc protégées des accès externes.



32732 CONNECT REMOTE

remote control; plastic, white
Fernbedienung; Kunststoff, weiss
Télécommande; plastique, blanc

L 110, B 53, H 20



AAA,
R03P1,5V



9 002759 327323



B 53



97475 CONNECT SENSOR

accessory; plastic, white
Zubehör; Kunststoff, weiss
accessoire; plastique, blanc

L 60, H 60, A 40



AA,
LR6 HP

2900mA,
1,5V

IP44



9 002759 974756



A 40



30°

Schwenkbereich von
rechts nach links

97475

With the mounting bracket (included in the delivery), you can easily adjust the detection range to your needs. This permits fine adjustment by 30 degrees to the left and right.

Mit der Montagehalterung (im Lieferumfang enthalten) können Sie den Erfassungsbereich ganz einfach an Ihre Bedürfnisse anpassen. Dadurch ist eine Feinjustierung von 30 Grad nach links und rechts möglich.

Avec le support de montage (inclus dans la livraison), vous pouvez facilement ajuster l'étendue de la détection à vos besoins. Ce réglage fin de 30 degrés à gauche et à droite est possible.



97295 PIOVE-C

wall / ceiling light; cast aluminium, black / plastic, white
Wand- / Deckenleuchte; Aluguss, schwarz / Kunststoff, weiss
applique / plafonnier; fonte d'aluminium, noir / plastique, blanc

L 250, H 250, A 80



14W



1400lm



Remote,
App



IP44



9 002759 972950



L 250



97237 LOCANA-C

wall / ceiling light; zinc-plated steel, anthracite / plastic, white
Wand- / Deckenleuchte; Stahl verzinkt, anthrazit / Kunststoff, weiss
applique / plafonnier; acier galvanisé, anthracite / plastique, blanc

H 95, Ø 260



14W



1400lm



Remote,
App



IP44



9 002759 972370



Ø 260



97299 LOCANA-C

wall / ceiling light; zinc-plated steel, silver / plastic, white
Wand- / Deckenleuchte; Stahl verzinkt, silber / Kunststoff, weiss
applique / plafonnier; acier galvanisé, argent / plastique, blanc

H 95, Ø 260



14W



1400lm



Remote,
App



IP44



9 002759 972998



Ø 260



98172 ARGOLIS-C

wall / ceiling light; cast aluminium, white / plastic, white
Wand- / Deckenleuchte; Aluguss, weiss / Kunststoff, weiss
applique / plafonnier; fonte d'aluminium, blanc / plastique, blanc

L 300, B 300, H 35

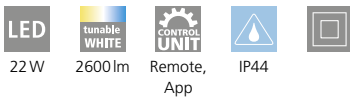

22W 2600lm Remote, App



9 002759 981723



L 300



98171 ARGOLIS-C

wall / ceiling light; cast aluminium, white / plastic, white
Wand- / Deckenleuchte; Aluguss, weiss / Kunststoff, weiss
applique / plafonnier; fonte d'aluminium, blanc / plastique, blanc

H 35, Ø 225

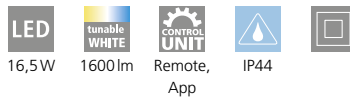

16,5W 1600lm Remote, App



9 002759 981716



Ø 225

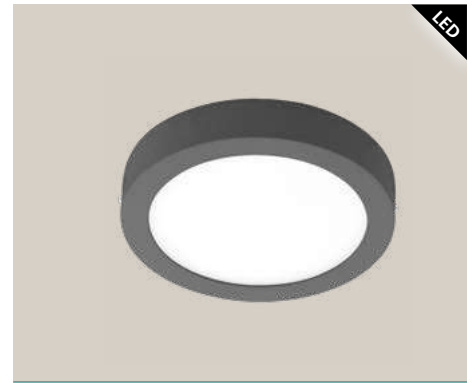

98173 ARGOLIS-C

wall / ceiling light; cast aluminium, anthracite / plastic, white
Wand- / Deckenleuchte; Aluguss, anthrazit / Kunststoff, weiss
applique / plafonnier; fonte d'aluminium, anthracite / plastique, blanc

H 35, Ø 225

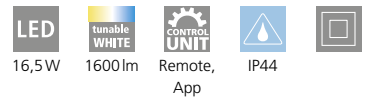

16,5W 1600lm Remote, App



9 002759 981730

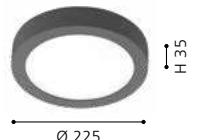

Ø 225



98174 ARGOLIS-C

wall / ceiling light; cast aluminium, anthracite / plastic, white
Wand- / Deckenleuchte; Aluguss, anthrazit / Kunststoff, weiss
applique / plafonnier; fonte d'aluminium, anthracite / plastique, blanc

L 300, B 300, H 35

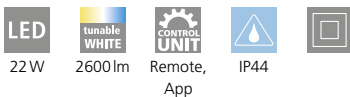

22W 2600lm Remote, App



9 002759 981747

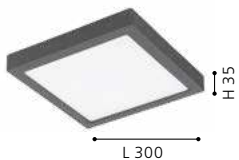

L 300



98172





**DIMMABLE
VIA REMOTE
AND APP**

97219



97219 TORAZZA-C

wall light; plastic, steel, anthracite / plastic, satined
Wandleuchte; Kunststoff, Stahl, anthrazit / Kunststoff, satiniert
applique; plastique, acier, anthracite / plastique, satiné

L 215, H 215, A 70

14W	1400lm	Remote, App	IP44	



97219

This luminaire is delivered with freely positionable ornamental elements which are attached by means of adhesive tape.

Diese Leuchte wird mit frei positionierbaren Zierelementen geliefert, welche mittels Klebeband angebracht werden.

Ce luminaire est livrée avec éléments de décoration qui sont attachés au moyen du ruban adhésif.



9 002759 972196



98234 FRANCARI-C

wall light; cast aluminium, black / plastic, white
Wandleuchte; Aluguss, schwarz / Kunststoff, weiss
applique; fonte d'aluminium, noir / plastique, blanc

L 220, H 255, A 250

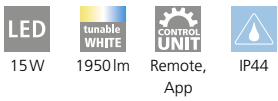

9 002759 982348



98145 MARCHESA-C

wall light; stainless steel, stainless steel / plastic, white
Wandleuchte; Edelstahl, edelstahl / Kunststoff, weiss
applique; acier inoxydable, acier inoxydable / plastique, blanc

H 70, Ø 300

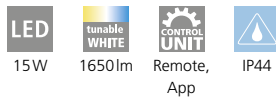

9 002759 981457



EGLO connect

Our EGLO connect outdoor lamps withstand any weather condition. They offer an attractive complimentary package, together with our indoor lamps.

Unsere EGLO connect Außenleuchten halten jeder Witterung stand und bilden zusammen mit unseren Innenleuchten ein attraktives Gesamtpaket.

Nos luminaires extérieurs EGLO connect résistent à toute intempérie et forment communément avec nosres luminaires intérieurs un ensemble attrayant.



1x

A-F

3x

0-9

97219, 98145

Letters and numbers included in delivery.

Buchstaben und Zahlen im Lieferumfang enthalten.

Les lettres et les nombres sont inclus dans la livraison.



98145



806 lm

5 year warranty
5 Jahre Garantie
5 años de garantía
5 anni di garanzia

11684 LED-E27-A60

Bulb; plastic, opal
Leuchtmittel; Kunststoff, opal
Ampoule; plastique, opale

L 118, Ø 60

E27	1x 9W	warm WHITE 3000K	25000h	CONTROL UNIT Remote, App
220-240V, 50/60Hz	15000x	CRI >80		



9 002759 116842



97239 VERRES-C

wall light; stainless steel, plastic, stainless steel, white / plastic, white
Wandleuchte; Edelstahl, Kunststoff, edelstahl, weiss / Kunststoff, weiss
applique; acier inoxydable, plastique, acier inoxydable, blanc / plastique, blanc

L 180, H 290, A 90

E27	1x 9W	warm WHITE 1x 806lm	IP44	
-----	-------	------------------------	------	--



9 002759 972394

9W ~ 60W



EGLO CONNECT E27

The EGLO connect E27 lamp 11684 is included in the delivery of all luminaires on pages 20 to 22.

Das EGLO connect E27 Leuchtmittel 11684 ist bei allen Leuchten auf den Seiten 20 bis 22 im Lieferumfang inkludiert.

L'ampoule EGLO E27 connect de référence 11684 est livrée avec tous les luminaires des pages 20 à 22.





LED

97483 CALDIERO-C

floor light; zinc-plated steel, anthracite / plastic, white
 Stehleuchte; Stahl verzinkt, anthrazit / Kunststoff, weiss
 lampadaire; acier galvanisé, anthracite / plastique, blanc

L 240, B 140, H 965, Base: Ø 140

- E27
- 1x 9W
- warm WHITE
1x
806lm
- IP44

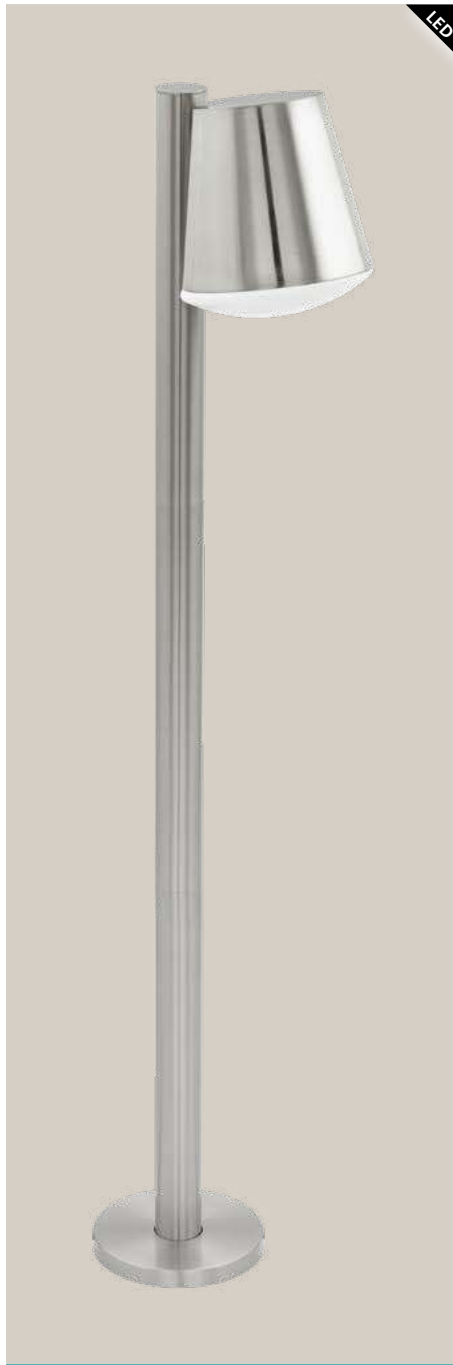
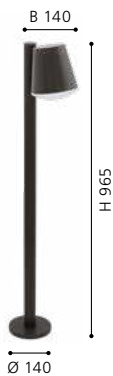

LED

97485 CALDIERO-C

floor light; stainless steel, stainless steel / plastic, white
 Stehleuchte; Edelstahl, edelstahl / Kunststoff, weiss
 lampadaire; acier inoxydable, acier inoxydable / plastique, blanc

L 240, B 140, H 965, Base: Ø 140

- E27
- 1x 9W
- warm WHITE
1x
806lm
- IP44



LED

97482 CALDIERO-C

wall light; zinc-plated steel, anthracite / plastic, white
 Wandleuchte; Stahl verzinkt, anthrazit / Kunststoff, weiss
 applique; acier galvanisé, anthracite / plastique, blanc

L 140, H 240, A 190

- E27
- 1x 9W
- warm WHITE
1x
806lm
- IP44



LED

97484 CALDIERO-C

wall light; stainless steel, stainless steel / plastic, white
 Wandleuchte; Edelstahl, edelstahl / Kunststoff, weiss
 applique; acier inoxydable, acier inoxydable / plastique, blanc

L 140, H 240, A 190

- E27
- 1x 9W
- warm WHITE
1x
806lm
- IP44



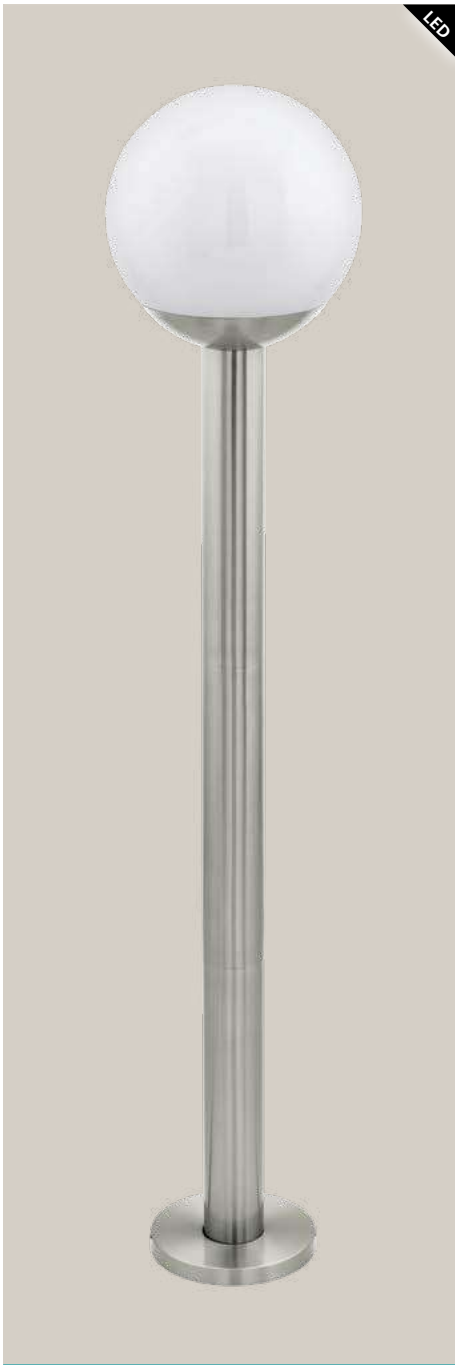

97249 NISIA-C

floor light; stainless steel, stainless steel / plastic, white
 Stehleuchte; Edelstahl, edelstahl / Kunststoff, weiss
 lampadaire; acier inoxydable, acier inoxydable / plastique, blanc

H 980, Ø 200, Base: Ø 140

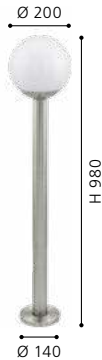
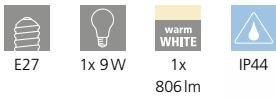

97248 NISIA-C

pedestal light; stainless steel, stainless steel / plastic, white
 Sockelleuchte; Edelstahl, edelstahl / Kunststoff, weiss
 luminaire pour socle; acier inoxydable, acier inoxydable / plastique, blanc

H 525, Ø 200, Base: Ø 140

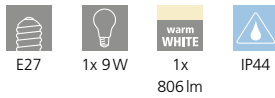

97247 NISIA-C

wall light; stainless steel, stainless steel / plastic, white
 Wandleuchte; Edelstahl, edelstahl / Kunststoff, weiss
 applique; acier inoxydable, acier inoxydable / plastique, blanc

L 200, H 315, A 220

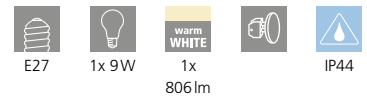



97247

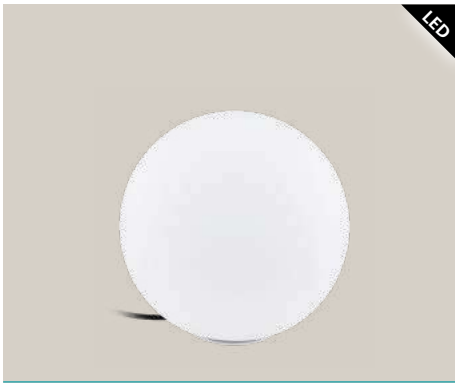

LED

98105 MONTEROLO-C

floor light; plastic, white / plastic, white
 Stehleuchte; Kunststoff, weiss / Kunststoff, weiss
 lampadaire; plastique, blanc / plastique, blanc

H 300, Ø 300, Base: Ø 120

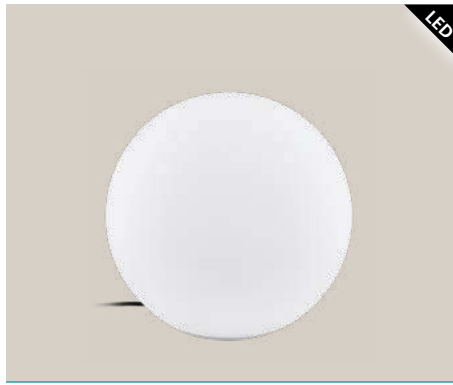
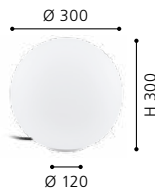
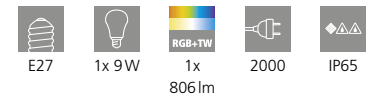

LED

98106 MONTEROLO-C

floor light; plastic, white / plastic, white
 Stehleuchte; Kunststoff, weiss / Kunststoff, weiss
 lampadaire; plastique, blanc / plastique, blanc

H 390, Ø 390, Base: Ø 195

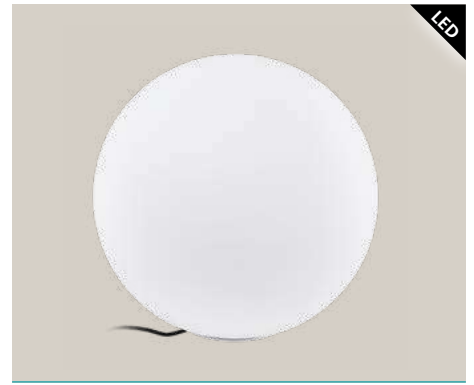
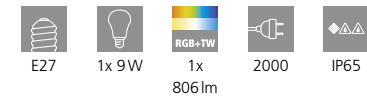

LED

98107 MONTEROLO-C

floor light; plastic, white / plastic, white
 Stehleuchte; Kunststoff, weiss / Kunststoff, weiss
 lampadaire; plastique, blanc / plastique, blanc

H 500, Ø 500, Base: Ø 195

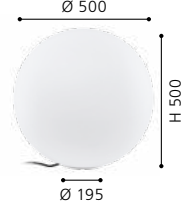

EGLO CONNECT E27 RGBTW

The EGLO connect E27 lamp 11586 is included in the delivery of all luminaires on page 24.

Das EGLO connect E27 Leuchtmittel 11586 ist bei allen Leuchten auf der Seite 24 im Lieferumfang inkludiert.

L'ampoule EGLO E27 connect de référence 11586 est livrée avec tous les luminaires de page 24.

DIMMABLE VIA REMOTE AND APP

98105

98107

98106



LED

806 lm

5 year warranty / 5 años de garantía / 5 años de garantía

11586 E27-LED-RGBTW-A60

Bulb; plastic
 Leuchtmittel; Kunststoff
 Ampoule; plastique

L 118, Ø 60

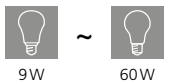
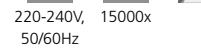



LED

98108 MONTEROLO-C

floor light; plastic, white / plastic, white
 Stehleuchte; Kunststoff, weiss / Kunststoff, weiss
 lampadaire; plastique, blanc / plastique, blanc

H 600, Ø 600, Base: Ø 195

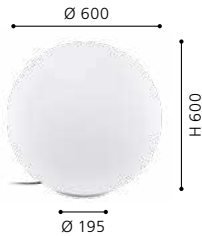
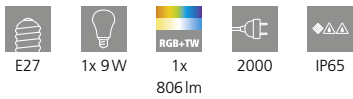

LED

345 lm

5 year warranty
 5 Jahre Garantie
 anni di garanzia
 años de garantía

11856 GU10-LED

Bulb; opal
 Leuchtmittel; opal
 Ampoule; opale

L 59, Ø 50

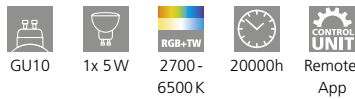

220-240V, 50/60Hz



25000x



45°



>80



DIMMABLE
 VIA REMOTE
 AND APP

EGLO CONNECT GU10 RGBTW

The EGLO connect GU10 lamp 11671 is included in the delivery of 98052 on page 25.

Das EGLO connect GU10 Leuchtmittel 11671 ist bei 98052 auf der Seite 25 im Lieferumfang inkludiert.

L'ampoule EGLO GU10 connect de référence 11671 est livrée avec tous 98052 de page 25.



98052 NEMA 1-C

ground spike; plastic, black / plastic, transparent
 Erdspieß; Kunststoff, schwarz / Kunststoff, transparent
 piquet de terre; plastique, noir / plastique, transparent

L 130, B 60, H 245



98052



500 lm

5 year warranty
Jahre Garantie
anni di garanzia
años de garantía

11864 E27-LED-A60

Bulb; glass, amber
Leuchtmittel; Glas, amber
Ampoule; verre, ambre



500 lm

5 year warranty
Jahre Garantie
anni di garanzia
años de garantía

11865 E27-LED-ST64

Bulb; glass, amber
Leuchtmittel; Glas, amber
Ampoule; verre, ambre



500 lm

5 year warranty
Jahre Garantie
anni di garanzia
años de garantía

12572 E27-LED-G80

Bulb; glass, amber
Leuchtmittel; Glas, amber
Ampoule; verre, ambre

L 105, Ø 60

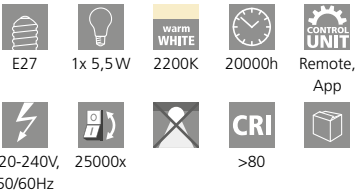

A+

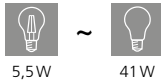

L 142, Ø 64



A+



L 120, Ø 80

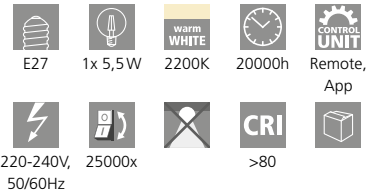

A+



NEW EGLO CONNECT FILAMENT

With these new, noble filament illuminants, you can give your classic outdoor luminaires a perfect look.

Mit diesen neuen, edlen Filamentleuchtmitteln verleihen Sie ihren klassischen Aussenleuchten eine perfekte Optik.

Avec ces nouveaux éclairages à filament nobles, vous pouvez donner à vos luminaires d'extérieur classiques un look parfait.

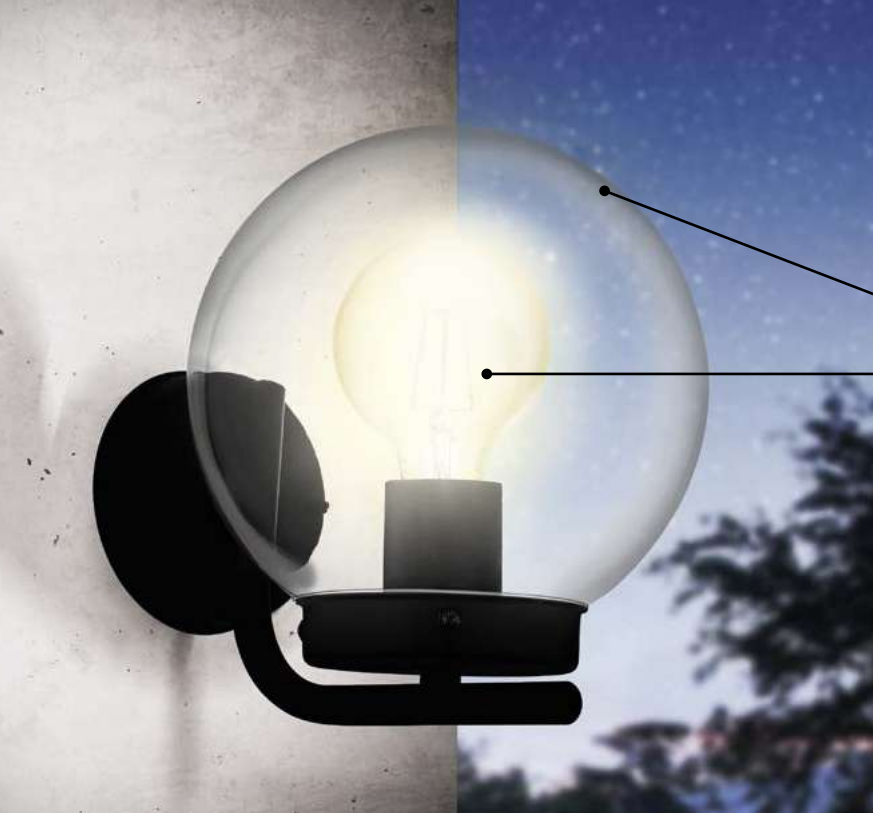

12572
99598



11864
98714



11865
97296



SAFETY & COMFORT





SAFETY & COMFORT



Light at the right time

Smart light activated by movements offers many advantages. EGLO sensor luminaires and sensors provide you with a great deal of comfort in your daily life and increase the safety of your own four walls.

Licht zum richtigen Zeitpunkt

Smartes Licht, das durch Bewegungen aktiviert wird, bietet Ihnen viele Vorteile. Mit den Sensorleuchten und Sensoren von EGLO bringen Sie erheblichen Komfort in Ihren Alltag und erhöhen die Sicherheit rund um Ihr Zuhause.

Lumière au bon moment

Lumière intelligente, qui est activé par le mouvement, offre de nombreux avantages. Avec les lumières des capteurs et des capteurs de EGLO apporter un confort considérable dans votre vie quotidienne et d'augmenter la sécurité de vos propres quatre murs.



1. COMFORT



2. SAFETY



3. SECURITY



4. SAVE MONEY

1. COMFORT

The light comes on – without requiring you to push a button, leaving your hands free to carry your shopping bags. Come home comfortably with the sensors and sensor lamps by EGLO.

2. SAFETY

EGLO sensors and sensor lamps will show you thresholds and tripping hazards in time. Lower your accident risk in and around your home.

3. SECURITY

Motion detection will safely light up badly visible areas when this is necessary. You will always be able to see what is happening and can deter unbidden guests with the EGLO sensors and sensor lamps.

4. SAVE MONEY

Sensors and sensor lamps by EGLO help you save money. Your light will only come on when it is needed, and lower the energy costs for every home.

1. KOMFORT

Das Licht geht an – ohne dass Sie einen Schalter drücken mussten und Sie haben die Hände frei, um die Einkäufe zu tragen. Kommen Sie komfortabel nach Hause mit den Sensoren und Sensorleuchten von EGLO.

2. SICHERHEIT

EGLO Sensoren und Sensorleuchten lassen Sie Schwellen und Stolperfallen rechtzeitig erkennen. Senken Sie dadurch das Unfallrisiko in und um Ihr Zuhause.

3. SCHUTZ

Durch die Erfassung von Bewegung können schlecht einsichtbare Bereiche beleuchtet werden, wenn es notwendig ist. Sehen Sie immer was passiert und schrecken Sie ungebetene Gäste mit EGLO Sensoren und Sensorleuchten ab.

4. GELD SPAREN

Sensoren und Sensorleuchten von EGLO helfen Ihnen bares Geld zu sparen. Das Licht geht nur an wenn es benötigt wird und senkt damit die Energiekosten in Ihrem Zuhause.

1. COMFORT

La lumière s’allume – sans que vous n’avez besoin de presser un interrupteur et vous avez les mains libres pour porter les achats. Entrez confortablement chez vous avec les capteurs et les luminaires à capteurs d’EGLO.

2. SÛRETÉ

Les capteurs et les luminaires à capteurs d’EGO vous permettent de déceler d’avance les seuils et sources de trébuchement. Réduisez ainsi les risques d’accident dans et autour de votre foyer.

3. SÉCURITÉ

Il est possible grâce à la saisie des mouvements d’éclairer au besoin des zones difficiles à voir. Ayez toujours un œil sur ce qu’il se passe et découragez les intrus avec les capteurs et les lampes à capteur d’EGO.

4. DE L’ARGENT EN SÉCURITÉ

Les capteurs et les lampes à capteur d’EGLO vous aident à économiser de l’argent comptant. La lumière ne vient que lorsque celle-ci est requise, ce qui réduit ainsi les dépenses énergétiques de tout foyer.

OVERVIEW

SAFETY & COMFORT

Chapter / Kapitel / Chapitre Modern / Sensor



RIFORANO
42



MANFRIA
46



PALOSCO
51



FIUMICINO
54



CALDIERO
58



CALDIERO
58



NISIA
64



POLIENTO
65



RUBIO
66



SORRONARO
67



MADRIZ
68



CASAZZA
69



FRANCARI
84



PERNATE
84



TRONO STICK
89



RIGA 5
93



RIGA 5
93



RIGA 5
93



SESIMBA 1
96



SESIMBA 1
96



SESIMBA 1
96



BREGANZO 1
100



MUSSOTTO
100



VERRES
100



CITY
103



CITY
103



CERNO
105



CITY
105



HELSINKI
62



HELSINKI
62



HELSINKI
63



CASAZZA
69



SALVANESCO
74



AZZINANO
81



RIGA 5
93



ATOLLARI
95



ATOLLARI
95



BREGANZO 1
100



TRIBANO
102



CERNO
103



OVERVIEW

SAFETY & COMFORT

Chapter / Kapitel / Chapitre **Topline / Sensor**



SAKEDA
112



BELCREDA
116



BELCREDA
116



CHEIRA
118

Chapter / Kapitel / Chapitre **Classic / Sensor**



RAVELLO
130



SIRMIONE
132



SIDNEY
134



LISIO
135



SOSSANO
136



NAVEDO
154



NAVEDO
158



MANERBIO
158



LATERNA 4
161



LATERNA 5
163



OVERVIEW

SAFETY & COMFORT

Chapter / Kapitel / Chapitre

Spots / Recessed & Accessoires / Sensor



PAGINO
168



PAGINO
168



PAGINO
168



CASABAS
168



CASABAS
168



LAMOZZO
170



LAMOZZO 1
170



PALIZZI
172



PASTION
172



CASABAS
172



CASABAS
172



DETECT ME 6
176



DETECT ME 6
176



DETECT ME 3
176



DETECT ME 3
176



DETECT ME 4
176



DETECT ME 4
176



DETECT ME 1
177



DETECT ME 1
177



FAEDO 3
180



FAEDO 3
180



FAEDO 3
180



FAEDO 3
180



FAEDO 3
185



FAEDO 3
185



FAEDO 3
185



FAEDO 3
185



MODERN

MODERN
MODERNE

CLEAR LINES - A straight-lined and minimalist design ensures a modern touch. The luminaires made of stainless steel, aluminium or steel, combined with refined glass elements, will make your outdoor area shine in a modern and yet timeless light.

KLARE LINIEN - Geradliniges und minimalistisches Design sorgt für einen modernen Touch. Die Leuchten aus Edelstahl, Aluminium oder Stahl, kombiniert mit edlen Glaselementen, lassen Ihren Außenbereich modern und dennoch zeitlos erstrahlen.



LIGNES DISTINCTIVES - Un design minimaliste et à lignes droites assure un flair moderne. Associés à de nobles éléments en verre, les luminaires en acier, acier inoxydable ou en aluminium laissent votre extérieur rayonner d'un aspect moderne et pourtant intemporel.



OVERVIEW

MODERN



RIFORANO
42



NEMBRO
44



MANFRIA
46



DONINNI 1
48



BRIANZA
50



PALOSCO
51



MELZO
52



FIUMICINO
54



DONATORI
56



PRATA VECCHIA
57



CALDIERO
58



BASALGO 1
60



HELSINKI
62



NISIA
64



ONCALA
64



POLIENTO
65



CORRIENTES
66



RUBIO
66



SORRONARO
67



MADRIZ
68



CASAZZA
69



ARGOLIS
70



SONELLA
70



INFESTO 1
71



MARCHESA
72



MONGODIO
73



PILONE
73



VENTO 1
73



VENTO 2
73



AMAROSI
74



SALVANESCO
74



CULPINA
75



CORNALE
76



MONTEROS
77



ADAMELLO
78



ALBENZA
78



EREDITA
78



KIBEA
78



NADELA
78



SITIA
79



ACATE
80



CALGARY 1
80



PIAS
80



TABO
80



AZZINANO
81



RALORA
81



JORBA
82



PERAFITA
83



BOSARO
84



FRANCAI
84



PERNATE
84



GORZANO
86



MORINO
86



REDONDO
86



LAGASCO
87



PREDAZZO
87



BEVERLY
88



ROBLEDO
88



STOCKHOLM 1
88



FANTECOLO
89



TRONO STICK
89



AGOLADA
90



RIGA
91



RIGA-LED
92



TONEGO
92



RIGA 5
93



CISTIerna
95



CISTIerna 1
95



ATOLLARI
94



SESIMBA
96



SESIMBA 1
96



TREVILO
98



TREVILO 1
98



CHINOA
99



PASSIRANO
99



BREGANZO
100



BREGANZO 1
100



MUSSOTTO
100



PARK
100



VERRES
100



TRIBANO
102



CERNO
103



CITY
103



DARIL 1
104



LEPUS
106



ONJA
106



MILTON
107



SEVILLA
107



ENTRIMO
107

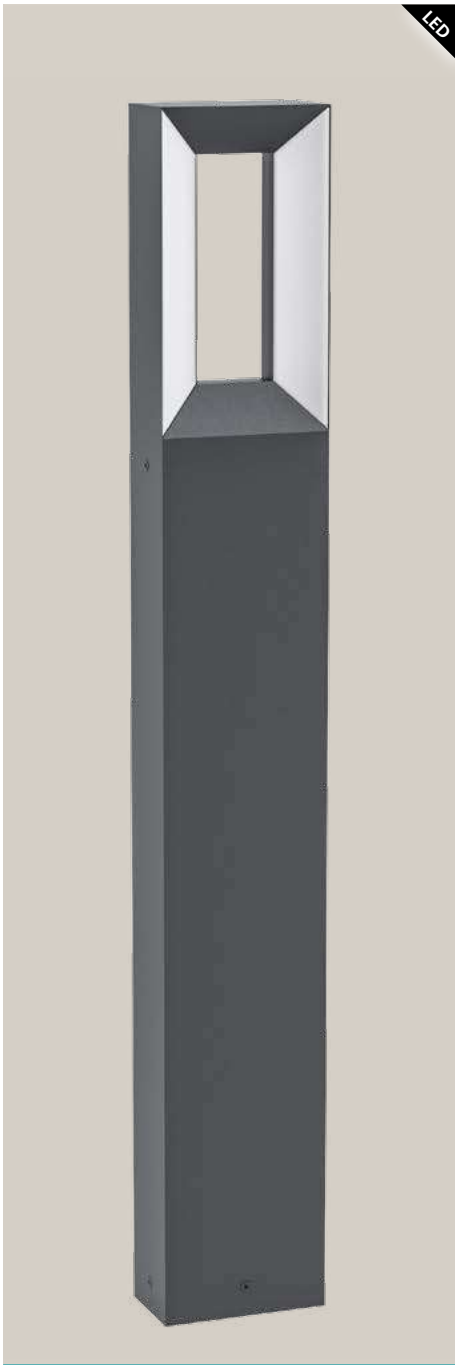

LED



LED

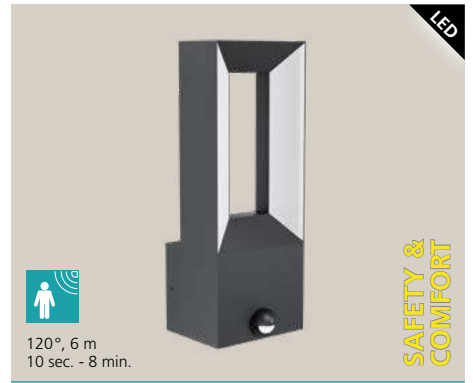

LED



120°, 6 m
10 sec. - 8 min.

SAFETY &
COMFORT

98725 RIFORANO

wall light; cast aluminium, black / plastic, white
Wandleuchte; Aluguss, schwarz / Kunststoff, weiss
applique; fonte d'aluminium, noir / plastique, blanc

L 110, H 290, A 85



2x 5W



2x
550lm



IP44



9 002759 987251



98726 RIFORANO

wall light; cast aluminium, black / plastic, white
Wandleuchte; Aluguss, schwarz / Kunststoff, weiss
applique; fonte d'aluminium, noir / plastique, blanc

L 110, H 290, A 95



2x 5W



2x
550lm



IP44



9 002759 987268



98728 RIFORANO

floor light; cast aluminium, black / plastic, white
Stehleuchte; Aluguss, schwarz / Kunststoff, weiss
lampadaire; fonte d'aluminium, noir / plastique, blanc

L 110, B 60, H 770



2x 5W



2x
550lm



IP44



9 002759 987282



98727 RIFORANO

pedestal light; cast aluminium, black / plastic, white
Sockelleuchte; Aluguss, schwarz / Kunststoff, weiss
luminaire pour socle; fonte d'aluminium, noir / plastique, blanc

L 110, B 60, H 340



2x 5W



2x
550lm



IP44



9 002759 987275





98726

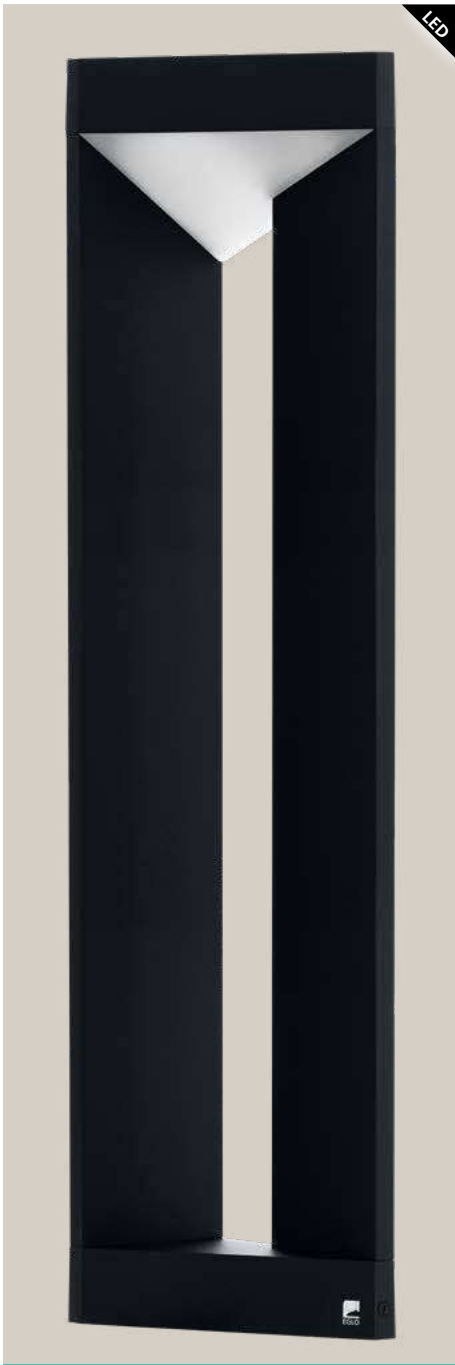

98751 NEMBRO

floor light; cast aluminium, black / plastic, white
 Stehleuchte; Aluguss, schwarz / Kunststoff, weiss
 lampadaire; fonte d'aluminium, noir / plastique, blanc

L 200, B 110, H 800

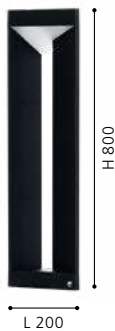

98749 NEMBRO

pedestal light; cast aluminium, black / plastic, white
 Sockelleuchte; Aluguss, schwarz / Kunststoff, weiss
 luminaire pour socle; fonte d'aluminium, noir / plastique, blanc

L 200, B 110, H 380



98748 NEMBRO

wall light; cast aluminium, black / plastic, white
 Wandleuchte; Aluguss, schwarz / Kunststoff, weiss
 applique; fonte d'aluminium, noir / plastique, blanc

L 200, H 290, A 135





98748



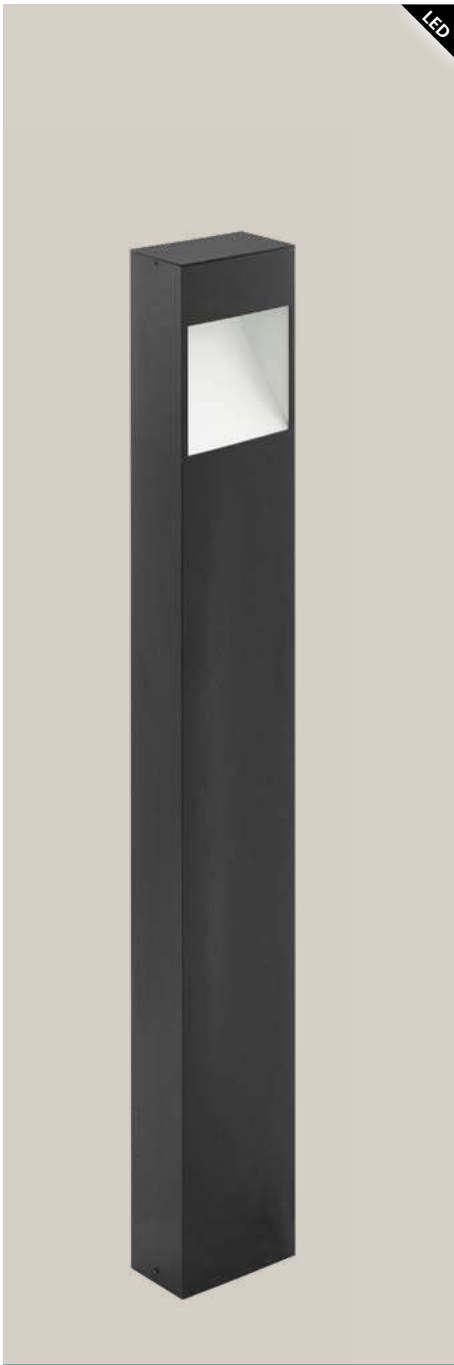

98097 MANFRIA

floor light; aluminium, anthracite, white
 Stehleuchte; Alu, anthrazit, weiss
 lampadaire; aluminium, anthracite, blanc

L 135, B 75, H 870



10W 830lm



9 002759 980979

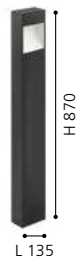

98098 MANFRIA

wall light; aluminium, anthracite, white
 Wandleuchte; Alu, anthrazit, weiss
 applique; aluminium, anthracite, blanc

L 200, H 325, A 80



10W 830lm



9 002759 980986



98095 MANFRIA

wall light; aluminium, anthracite, white
 Wandleuchte; Alu, anthrazit, weiss
 applique; aluminium, anthracite, blanc

L 200, H 300, A 80



10W 830lm



9 002759 980955



98096 MANFRIA

pedestal light; aluminium, anthracite, white
 Sockelleuchte; Alu, anthrazit, weiss
 luminaire pour socle; aluminium, anthracite, blanc

L 135, B 75, H 380



10W 830lm



9 002759 980962





98095

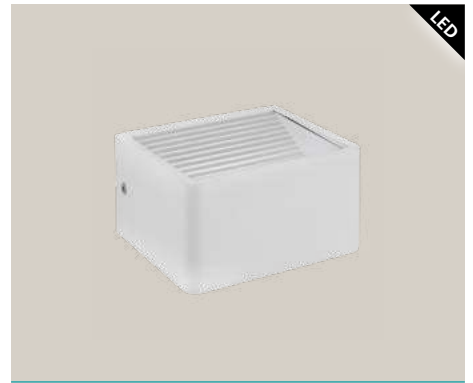
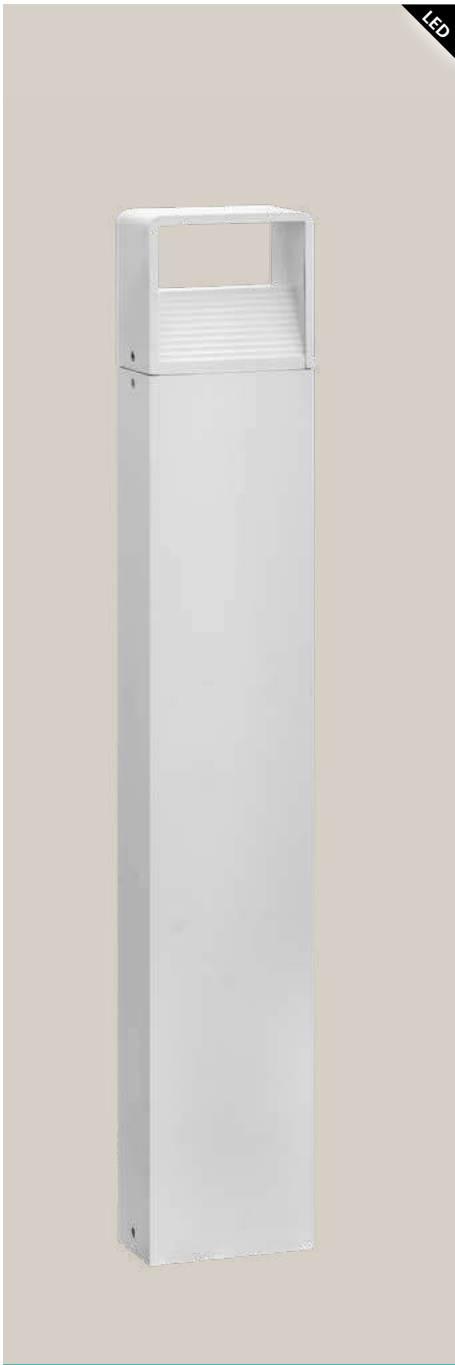

98267 DONINNI 1

pedestal light; aluminium, white / plastic, white
 Sockelleuchte; Alu, weiss / Kunststoff, weiss
 luminaire pour socle; aluminium, blanc / plastique, blanc

L 135, B 75, H 400



98266 DONINNI 1

wall light; aluminium, white / plastic, white
 Wandleuchte; Alu, weiss / Kunststoff, weiss
 applique; aluminium, blanc / plastique, blanc

L 135, B 120, H 75

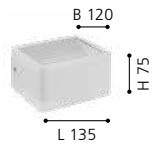

98268 DONINNI 1

floor light; aluminium, white / plastic, white
 Stehleuchte; Alu, weiss / Kunststoff, weiss
 lampadaire; aluminium, blanc / plastique, blanc

L 135, B 75, H 800



98271 DONINNI 1

pedestal light; aluminium, anthracite / plastic, white
 Sockelleuchte; Alu, anthrazit / Kunststoff, weiss
 luminaire pour socle; aluminium, anthracite / plastique, blanc

L 135, B 75, H 400



98269 DONINNI 1

wall light; aluminium, anthracite / plastic, white
 Wandleuchte; Alu, anthrazit / Kunststoff, weiss
 applique; aluminium, anthracite / plastique, blanc

L 135, B 120, H 75

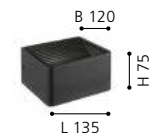



98272 DONINNI 1

floor light; aluminium, anthracite / plastic, white
Stehleuchte; Alu, anthrazit / Kunststoff, weiss
lampadaire; aluminium, anthracite / plastique, blanc

L 135, B 75, H 800

LED

6W

warm
WHITE

600lm



IP44



9 002759 982720



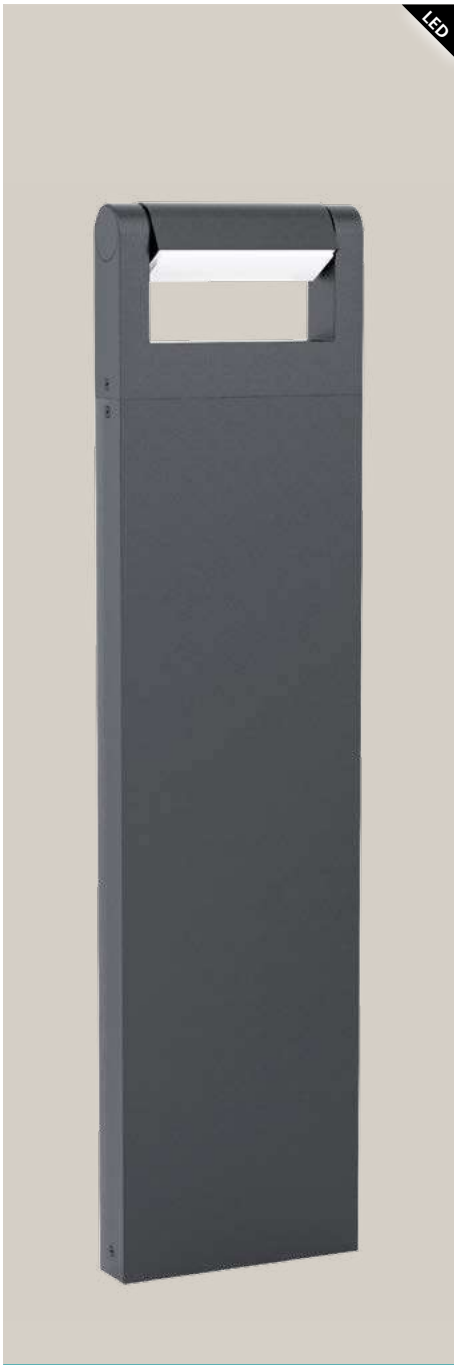

98708 BRIANZA

floor light; cast aluminium, black
 Stehleuchte; Aluguss, schwarz
 lampadaire; fonte d'aluminium, noir

L 200, B 45, H 800



98707 BRIANZA

wall light; cast aluminium, black
 Wandleuchte; Aluguss, schwarz
 applique; fonte d'aluminium, noir

L 200, H 50, A 140

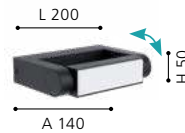

98707

The movable light head allows you to select different lighting scenes as required.

Durch den beweglichen Leuchtenkopf können Sie nach Belieben unterschiedliche Lichtszenen wählen.

La tête de luminaire mobile vous permet de sélectionner différentes scènes lumineuses en fonction de vos besoins.





98739 PALOSCO

floor light; zinc-plated steel, black / plastic, transparent
 Stehleuchte; Stahl verzinkt, schwarz / Kunststoff, transparent
 lampadaire; acier galvanisé, noir / plastique, transparent

L 140, B 220, H 820, Base: Ø 110

LED 6W warm WHITE IP44



9 002759 987398

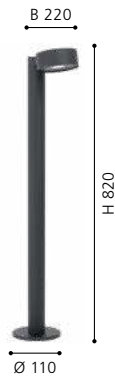

98737 PALOSCO

wall light; zinc-plated steel, black / plastic, transparent
 Wandleuchte; Stahl verzinkt, schwarz / Kunststoff, transparent
 applique; acier galvanisé, noir / plastique, transparent

L 115, H 170, A 155

LED 6W warm WHITE IP44



9 002759 987374



98738 PALOSCO

wall light; zinc-plated steel, black / plastic, transparent
 Wandleuchte; Stahl verzinkt, schwarz / Kunststoff, transparent
 applique; acier galvanisé, noir / plastique, transparent

L 115, H 170, A 155

LED 6W warm WHITE IP44



9 002759 987381





97632 MELZO

pedestal light; cast aluminium, black / plastic, transparent
 Sockelleuchte; Aluguss, schwarz / Kunststoff, transparent
 luminaire pour socle; fonte d'aluminium, noir / plastique, transparent

H 450, Ø 135



1x 11 W
 1x
 950lm



9 002759 976323



97303 MELZO

wall light; cast aluminium, black / plastic, transparent
 Wandleuchte; Aluguss, schwarz / Kunststoff, transparent
 applique; fonte d'aluminium, noir / plastique, transparent

H 130, Ø 135



1x 11 W
 1x
 950lm



9 002759 973032

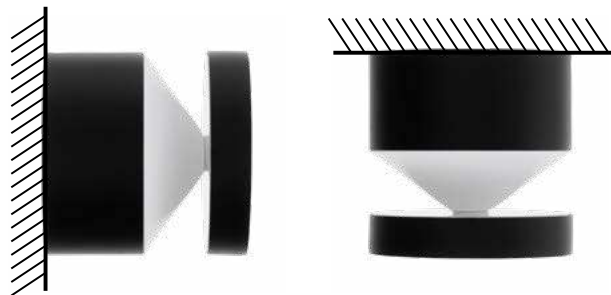

97304 MELZO

floor light; cast aluminium, black / plastic, transparent
 Stehleuchte; Aluguss, schwarz / Kunststoff, transparent
 lampadaire; fonte d'aluminium, noir / plastique, transparent

H 990, Ø 135



1x 11 W
 1x
 950lm



9 002759 973049

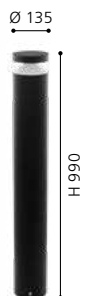

97303

These lamps have diverse uses: They can be installed on the wall or on the ceiling. The lamps variable design also permits floor placement.

Diese Leuchten sind vielseitig einsetzbar: sie können sowohl an der Wand, als auch an der Decke montiert werden. Ebenfalls ist durch das variable Design der Leuchte eine Bodenplatzierung möglich.

Ces luminaires sont d'une application multiple : ils peuvent être aussi bien montés sur le mur qu'attachés au plafond. Un placement au sol est aussi rendu possible par le design variable des luminaires.



97303



97304

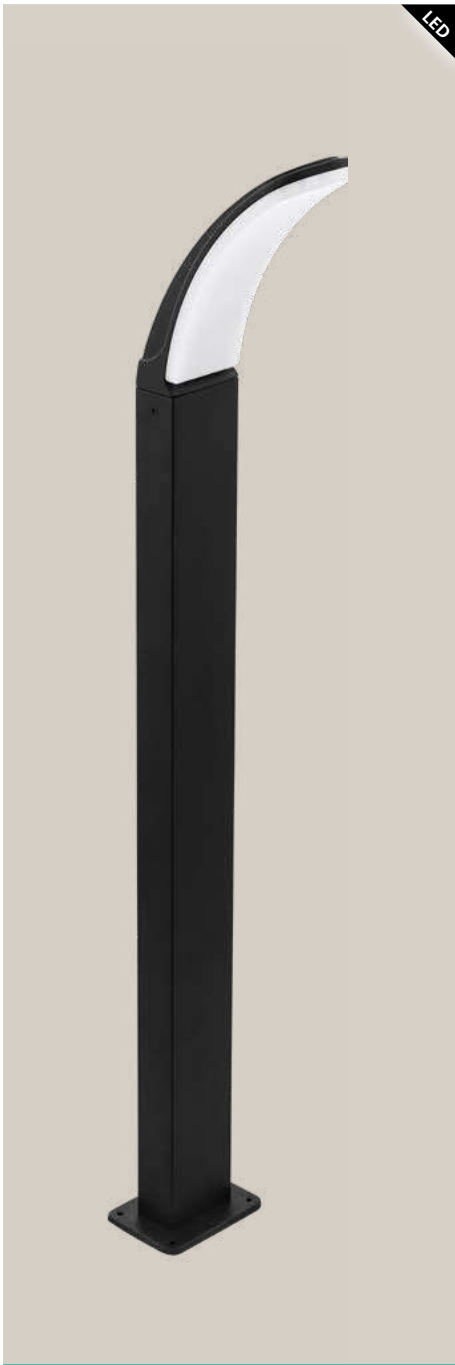

LED



LED



LED

98151 FIUMICINO

pedestal light; aluminium, black / plastic, white
 Sockelleuchte; Alu, schwarz / Kunststoff, weiss
 luminaire pour socle; aluminium, noir / plastique, blanc

H 450, Base: B 110, T 80

- 1x 11 W
- 1x 1300lm
-



9 002759 981518



98148 FIUMICINO

wall light; aluminium, black / plastic, white
 Wandleuchte; Alu, schwarz / Kunststoff, weiss
 applique; aluminium, noir / plastique, blanc

L 70, H 180, A 190

- 1x 11 W
- 1x 1300lm
-



9 002759 981488



LED

100°, 5 m
 5 sec. - 5 min.

SAFETY & COMFORT

98152 FIUMICINO

floor light; aluminium, black / plastic, white
 Stehleuchte; Alu, schwarz / Kunststoff, weiss
 lampadaire; aluminium, noir / plastique, blanc

H 900, Base: B 110, T 80

- 1x 11 W
- 1x 1300lm
-



9 002759 981525



98149 FIUMICINO

wall light; aluminium, black / plastic, white
 Wandleuchte; Alu, schwarz / Kunststoff, weiss
 applique; aluminium, noir / plastique, blanc

L 70, H 180, A 190

- 1x 11 W
- 1x 1300lm
-

IP44



9 002759 981495





98148



98701 DONATORI

wall light; aluminium, plastic, black / glass, clear
Wandleuchte; Alu, Kunststoff, schwarz / Glas, klar
applique; aluminium, plastique, noir / verre, clair

L 155, H 260, A 190



98702 DONATORI

pedestal light; cast aluminium, black / glass, clear
Sockelleuchte; Aluguss, schwarz / Glas, klar
luminaire pour socle; fonte d'aluminium, noir / verre, clair

H 310, Ø 155, Base: Ø 130



98703 DONATORI

floor light; cast aluminium, black / glass, clear
Stehleuchte; Aluguss, schwarz / Glas, klar
lampadaire; fonte d'aluminium, noir / verre, clair

H 990, Ø 155, Base: Ø 130

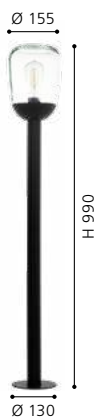

98701



98731 PRATA VECCHIA

wall light; zinc-plated steel, black / plastic, white
Wandleuchte; Stahl verzinkt, schwarz / Kunststoff, weiss
applique; acier galvanisé, noir / plastique, blanc

L 200, H 260, A 285



98732 PRATA VECCHIA

pedestal light; zinc-plated steel, black / plastic, white
Sockelleuchte; Stahl verzinkt, schwarz / Kunststoff, weiss
luminaire pour socle; acier galvanisé, noir / plastique, blanc

L 320, B 200, H 450, Base: B 220, T 40



98733 PRATA VECCHIA

floor light; zinc-plated steel, black / plastic, white
Stehleuchte; Stahl verzinkt, schwarz / Kunststoff, weiss
lampadaire; acier galvanisé, noir / plastique, blanc

L 320, B 200, H 850, Base: B 220, T 40

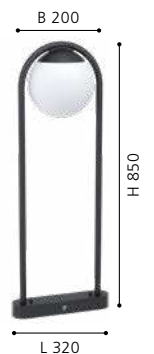



97147 CALDIERO

floor light; zinc-plated steel, anthracite / plastic, white
 Stehleuchte; Stahl verzinkt, anthrazit / Kunststoff, weiss
 lampadaire; acier galvanisé, anthracite / plastique, blanc

L 240, B 140, H 965, Base: Ø 140

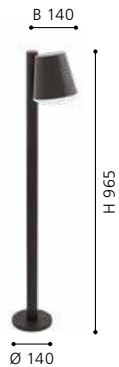

90°, 6 m
 10 sec. - 10 min.

**SAFETY &
 COMFORT**

97451 CALDIERO

wall light; zinc-plated steel, anthracite / plastic, white
 Wandleuchte; Stahl verzinkt, anthrazit / Kunststoff, weiss
 applique; acier galvanisé, anthracite / plastique, blanc

L 140, H 240, A 185



90°, 6 m
 10 sec. - 10 min.

**SAFETY &
 COMFORT**

97453 CALDIERO

wall light; stainless steel, stainless steel / plastic, white
 Wandleuchte; Edelstahl, edelstahl / Kunststoff, weiss
 applique; acier inoxydable, acier inoxydable / plastique, blanc

L 140, H 240, A 185



97146 CALDIERO

wall light; zinc-plated steel, anthracite / plastic, white
 Wandleuchte; Stahl verzinkt, anthrazit / Kunststoff, weiss
 applique; acier galvanisé, anthracite / plastique, blanc

L 140, H 240, A 185





97451





94277 BASALGO 1

wall light; stainless steel, stainless steel / plastic, clear, white
 Wandleuchte; Edelstahl, edelstahl / Kunststoff, klar, weiss
 applique; acier inoxydable, acier inoxydable / plastique, clair, blanc

L 105, H 180, A 210



1x 3,7W 1x 320lm



IP44



9 002759 942779



94278 BASALGO 1

floor light; stainless steel, stainless steel / plastic, clear, white
 Stehleuchte; Edelstahl, edelstahl / Kunststoff, klar, weiss
 lampadaire; acier inoxydable, acier inoxydable / plastique, clair, blanc

H 450, Ø 105



1x 3,7W 1x 320lm



9 002759 942786

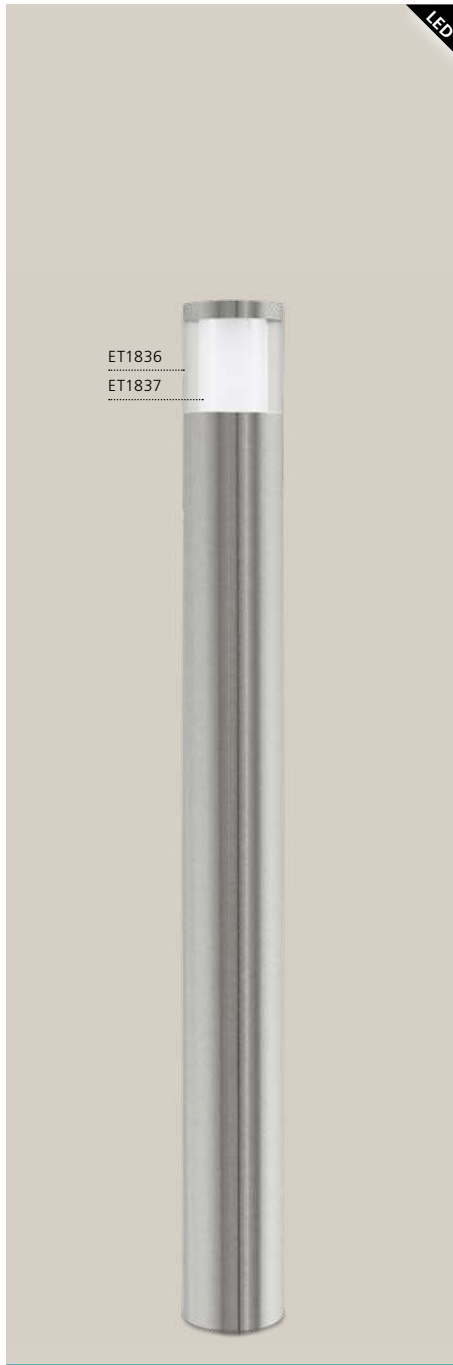

94279 BASALGO 1

floor light; stainless steel, stainless steel / plastic, clear, white
 Stehleuchte; Edelstahl, edelstahl / Kunststoff, klar, weiss
 lampadaire; acier inoxydable, acier inoxydable / plastique, clair, blanc

H 1050, Ø 105



1x 3,7W 1x 320lm



9 002759 942793

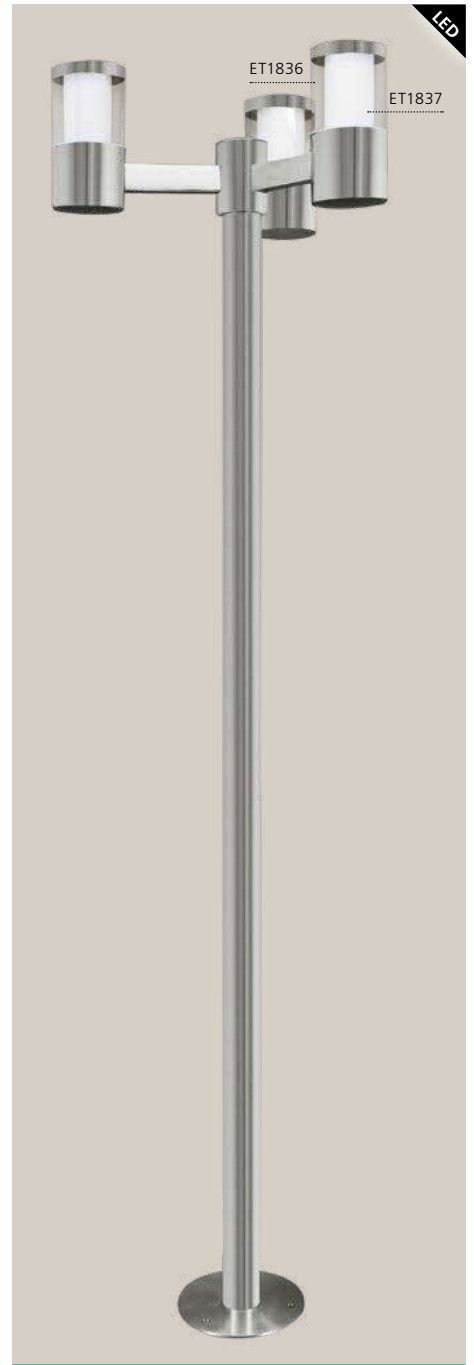

94281 BASALGO 1

floor light; stainless steel, stainless steel / plastic, clear, white
 Stehleuchte; Edelstahl, edelstahl / Kunststoff, klar, weiss
 lampadaire; acier inoxydable, acier inoxydable / plastique, clair, blanc

H 1900, Ø 490, Base: Ø 205



3x 3,7W 3x 320lm

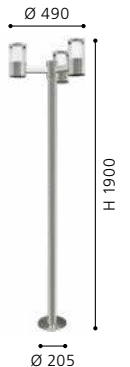

9 002759 942816



94278



94277



ET2436



110°, 5 m
15 sec. - 7 min.

**SAFETY &
COMFORT**

83281 HELSINKI

floor light; stainless steel, stainless steel / plastic, white
Stehleuchte; Edelstahl, edelstahl / Kunststoff, weiss
lampadaire; acier inoxydable, acier inoxydable / plastique, blanc

H 1100, Ø 75, Base: Ø 115



E27



1x 12W



IP44

Ø 75

H 1100

Ø 115



9 002759 832810



ET2436



ET2436



110°, 5 m
15 sec. - 7 min.

**SAFETY &
COMFORT**

83279 HELSINKI

floor light; stainless steel, stainless steel / plastic, white
Stehleuchte; Edelstahl, edelstahl / Kunststoff, weiss
lampadaire; acier inoxydable, acier inoxydable / plastique, blanc

H 450, Ø 75, Base: Ø 115



E27



1x 12W



IP44



9 002759 832797

Ø 75

H 450

Ø 115



ET2436

81751 HELSINKI

floor light; stainless steel, stainless steel / plastic, white
Stehleuchte; Edelstahl, edelstahl / Kunststoff, weiss
lampadaire; acier inoxydable, acier inoxydable / plastique, blanc

H 450, Ø 75, Base: Ø 115



E27



1x 12W



IP44

Ø 75

H 1100

Ø 115

H 1100, Ø 75, Base: Ø 115



E27



1x 12W



IP44



9 002759 817527



9 002759 817510

Ø 75

H 450

Ø 115

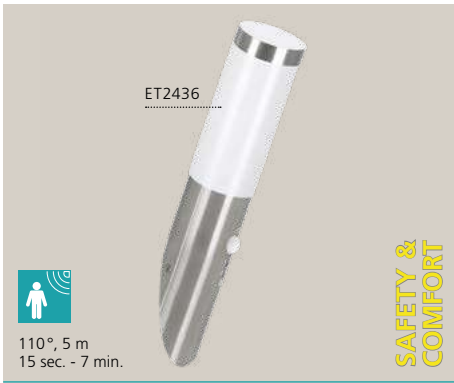

83278 HELSINKI

wall light; stainless steel, stainless steel / plastic, white
Wandleuchte; Edelstahl, edelstahl / Kunststoff, weiss
applique; acier inoxydable, acier inoxydable / plastique, blanc

H 425, Ø 75, A 165

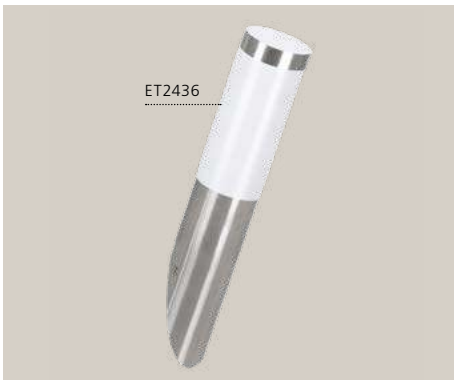

81753 HELSINKI

wall light; stainless steel, stainless steel / plastic, white
Wandleuchte; Edelstahl, edelstahl / Kunststoff, weiss
applique; acier inoxydable, acier inoxydable / plastique, blanc

H 390, Ø 75, A 165





GL2852



GL2852



90°, 8 m
5 sec. - 4 min.

**SAFETY &
COMFORT**



GL2852

27126 NISIA

wall light; stainless steel, stainless steel / glass, white

Wandleuchte; Edelstahl, edelstahl / Glas, weiss

applique; acier inoxydable, acier inoxydable / verre, blanc

L 200, H 355, A 240



E27



1x 60W



IP44



9 002759 271268



30206 NISIA

floor light; stainless steel, stainless steel / satin glass, white

Stehleuchte; Edelstahl, edelstahl / Glas satiniert, weiss

lampadaire; acier inoxydable, acier inoxydable / verre satiné, blanc

H 500, Ø 200, Base: Ø 130



E27



1x 60W



IP44



9 002759 302061



30207 NISIA

floor light; stainless steel, stainless steel / satin glass, white

Stehleuchte; Edelstahl, edelstahl / Glas satiniert, weiss

lampadaire; acier inoxydable, acier inoxydable / verre satiné, blanc

H 1000, Ø 200, Base: Ø 130



E27



1x 60W



IP44



9 002759 302078

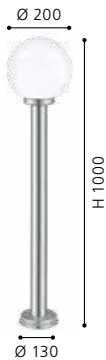

30205 NISIA

wall light; stainless steel, stainless steel / satin glass, white

Wandleuchte; Edelstahl, edelstahl / Glas satiniert, weiss

applique; acier inoxydable, acier inoxydable / verre satiné, blanc

L 200, H 360, A 240



E27



1x 60W



IP44



9 002759 302054



95982 ONCALA

wall light; stainless steel, stainless steel / satin glass, white

Wandleuchte; Edelstahl, edelstahl / Glas satiniert, weiss

applique; acier inoxydable, acier inoxydable / verre satiné, blanc

L 150, H 140, A 190



11W



950lm



IP44



IP44



IP44



IP44



9 002759 959821





90°, 7 m
10 sec. - 4 min.

**SAFETY &
COMFORT**

95017 POLIENTO

wall light; stainless steel, stainless steel /
plastic, glass, clear, white

Wandleuchte; Edelstahl, edelstahl /
Kunststoff, Glas, klar, weiss

applique; acier inoxydable, acier inoxydable /
plastique, verre, clair, blanc

L 150, H 325, A 195



E27



1x 40W



IP44



9 002759 950170



95016 POLIENTO

wall light; stainless steel, stainless steel /
plastic, glass, clear, white

Wandleuchte; Edelstahl, edelstahl /
Kunststoff, Glas, klar, weiss

applique; acier inoxydable, acier inoxydable /
plastique, verre, clair, blanc

L 150, H 325, A 195



E27



1x 40W



IP44



9 002759 950163



95016



120°, 1 m
5 sec. - 6 min.

**SAFETY &
COMFORT**

99573 RUBIO

wall light; cast aluminium, black / plastic, white
Wandleuchte; Aluguss, schwarz / Kunststoff, weiss
applique; fonte d'aluminium, noir / plastique, blanc

L 170, H 170, A 195



9 002759 995737



99572 RUBIO

wall light; cast aluminium, black / plastic, white
Wandleuchte; Aluguss, schwarz / Kunststoff, weiss
applique; fonte d'aluminium, noir / plastique, blanc

L 170, H 150, A 190



9 002759 995720



99581 CORRIENTES

wall light; aluminium, black / plastic, white
Wandleuchte; Alu, schwarz / Kunststoff, weiss
applique; aluminium, noir / plastique, blanc

L 185, H 180, A 160



9 002759 995812

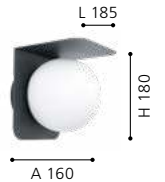

99572



99582 CORRIENTES

wall light; aluminium, white / plastic, white
Wandleuchte; Alu, weiss / Kunststoff, weiss
applique; aluminium, blanc / plastique, blanc

L 185, H 180, A 160



9 002759 995829

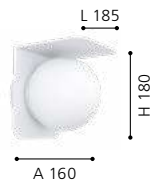



99579 SORRONARO

wall light; aluminium, plastic, black / plastic, transparent
Wandleuchte; Alu, Kunststoff, schwarz / Kunststoff, transparent
applique; aluminium, plastique, noir / plastique, transparent

L 170, H 120, A 140

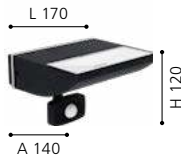

99578 SORRONARO

wall light; aluminium, plastic, black / plastic, transparent
Wandleuchte; Alu, Kunststoff, schwarz / Kunststoff, transparent
applique; aluminium, plastique, noir / plastique, transparent

L 170, H 50, A 140



99578

This luminaire can be mounted upwards or downwards.

Diese Leuchte kann aufwärts oder abwärts montiert werden.

Cette luminaire peut être montée vers le haut ou vers le bas.





99584



99583 MADRIZ

wall light; cast aluminium, black / plastic, white
Wandleuchte; Aluguss, schwarz / Kunststoff, weiss
applique; fonte d'aluminium, noir / plastique, blanc

L 230, H 190, A 50



99584 MADRIZ

wall light; cast aluminium, black / plastic, white
Wandleuchte; Aluguss, schwarz / Kunststoff, weiss
applique; fonte d'aluminium, noir / plastique, blanc

L 230, H 190, A 50





99521 CASAZZA

wall / ceiling light; zinc-plated steel, black / plastic, white
 Wand- / Deckenleuchte; Stahl verzinkt, schwarz / Kunststoff, weiss
 applique / plafonnier; acier galvanisé, noir / plastique, blanc

L 200, H 420, A 65



99522 CASAZZA

wall / ceiling light; zinc-plated steel, black / plastic, white
 Wand- / Deckenleuchte; Stahl verzinkt, schwarz / Kunststoff, weiss
 applique / plafonnier; acier galvanisé, noir / plastique, blanc

L 250, H 570, A 65



99533 CASAZZA

wall / ceiling light; zinc-plated steel, black / plastic, white
 Wand- / Deckenleuchte; Stahl verzinkt, schwarz / Kunststoff, weiss
 applique / plafonnier; acier galvanisé, noir / plastique, blanc

L 200, H 420, A 65



99534 CASAZZA

wall / ceiling light; zinc-plated steel, black / plastic, white
 Wand- / Deckenleuchte; Stahl verzinkt, schwarz / Kunststoff, weiss
 applique / plafonnier; acier galvanisé, noir / plastique, blanc

L 250, H 570, A 65





94871 SONELLA

wall / ceiling light; plastic, white / plastic, white

Wand- / Deckenleuchte; Kunststoff, weiss / Kunststoff, weiss

applique / plafonnier; plastique, blanc / plastique, blanc

L 215, H 215, A 70



8,2W 820lm



94872 SONELLA

wall / ceiling light; plastic, anthracite / plastic, white

Wand- / Deckenleuchte; Kunststoff, anthrazit / Kunststoff, weiss

applique / plafonnier; plastique, anthracite / plastique, blanc

L 215, H 215, A 70



8,2W 820lm



96494 ARGOLIS

wall / ceiling light; cast aluminium, white / plastic, white

Wand- / Deckenleuchte; Aluguss, weiss / Kunststoff, weiss

applique / plafonnier; fonte d'aluminium, blanc / plastique, blanc

L 300, B 300, H 40



22W 2600lm

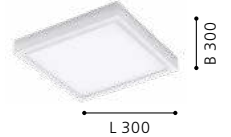

96495 ARGOLIS

wall / ceiling light; cast aluminium, anthracite / plastic, white

Wand- / Deckenleuchte; Aluguss, anthrazit / Kunststoff, weiss

applique / plafonnier; fonte d'aluminium, anthracite / plastique, blanc

L 300, B 300, H 40



22W 2600lm

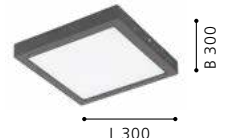



ET2173

94877 INFESTO 1

wall / ceiling light; stainless steel, plastic, stainless steel, silver / plastic, white

Wand- / Deckenleuchte; Edelstahl, Kunststoff, edelstahl, silber / Kunststoff, weiss

applique / plafonnier; acier inoxydable, plastique, acier inoxydable, argent / plastique, blanc

L 250, H 250, A 70

LED

8,2W

warm
WHITE

820lm



IP44



9 002759 948771

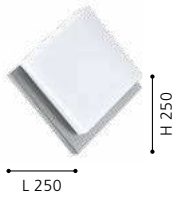

H 250

L 250



94877

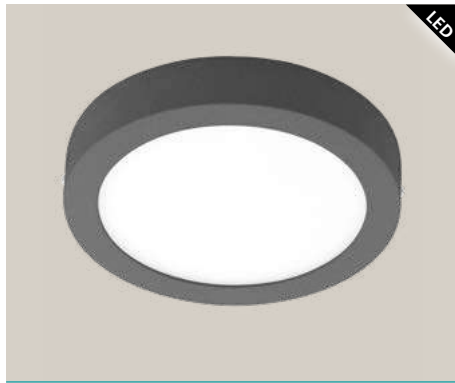
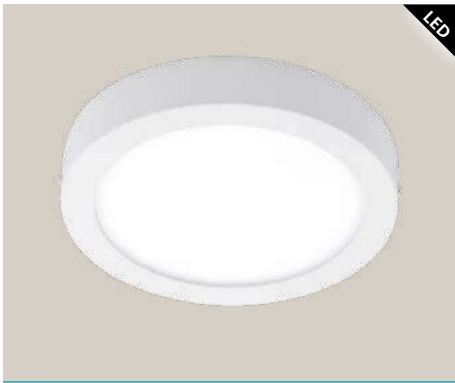

96491 ARGOLIS

wall / ceiling light; cast aluminium, white / plastic, white

Wand- / Deckenleuchte; Aluguss, weiss / Kunststoff, weiss

applique / plafonnier; fonte d'aluminium, blanc / plastique, blanc

H 35, Ø 225



96492 ARGOLIS

wall / ceiling light; cast aluminium, anthracite / plastic, white

Wand- / Deckenleuchte; Aluguss, anthrazit / Kunststoff, weiss

applique / plafonnier; fonte d'aluminium, anthracite / plastique, blanc

H 35, Ø 225



98147 MARCHESA

wall light; stainless steel, stainless steel / plastic, white

Wandleuchte; Edelstahl, edelstahl / Kunststoff, weiss

applique; acier inoxydable, acier inoxydable / plastique, blanc

H 70, Ø 300

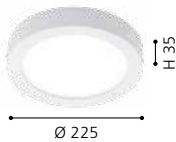

1x **A-F** 3x **0-9**

98147

Letters and numbers included in delivery.

Buchstaben und Zahlen im Lieferumfang enthalten.

Les lettres et les nombres sont inclus dans la livraison.



96365 VENTO 2

wall / ceiling light; stainless steel, stainless steel / plastic, white

Wand- / Deckenleuchte; Edelstahl, edelstahl / Kunststoff, weiss

applique / plafonnier; acier inoxydable, acier inoxydable / plastique, blanc

Ø 185, A 70



1x 5,4W
1x 410lm



9 002759 963651



Ø 185



94121 VENTO 1

wall / ceiling light; stainless steel, stainless steel / glass, white painted

Wand- / Deckenleuchte; Edelstahl, edelstahl / Glas, weiss lackiert

applique / plafonnier; acier inoxydable, acier inoxydable / verre, blanc laqué

Ø 285, A 80



11W
950lm



9 002759 941215



Ø 285



97254 PILONE

wall / ceiling light; steel, plastic, white / plastic, white

Wand- / Deckenleuchte; Stahl, Kunststoff, weiss / Kunststoff, weiss

applique / plafonnier; acier, plastique, blanc / plastique, blanc

H 70, Ø 300



1x 11W
1x 950lm



9 002759 972547

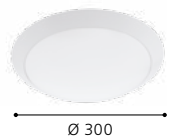

Ø 300



98712 MONGODIO

wall / ceiling light; zinc-plated steel, anthracite / plastic, white

Wand- / Deckenleuchte; Stahl verzinkt, anthrazit / Kunststoff, weiss

applique / plafonnier; acier galvanisé, anthracite / plastique, blanc

H 40, Ø 250



11,5W
1450lm



9 002759 987121



H 40



98712



98704 SALVANESCO

wall light; cast aluminium, black / plastic, white
Wandleuchte; Aluguss, schwarz / Kunststoff, weiss
applique; fonte d'aluminium, noir / plastique, blanc

L 180, H 240, A 90



98705 SALVANESCO

wall light; cast aluminium, black / plastic, white
Wandleuchte; Aluguss, schwarz / Kunststoff, weiss
applique; fonte d'aluminium, noir / plastique, blanc

L 180, H 240, A 90



98091 AMAROSI

wall light; aluminium, black / plastic, white
Wandleuchte; Alu, schwarz / Kunststoff, weiss
applique; aluminium, noir / plastique, blanc

L 170, H 210, A 205



98091, 98088, 98087

Letters and numbers included in delivery.

Buchstaben und Zahlen im Lieferumfang enthalten.

Les lettres et les nombres sont inclus dans la livraison.



98088 CULPINA

wall light; aluminium, anthracite / plastic, white
Wandleuchte; Alu, anthrazit / Kunststoff, weiss
applique; aluminium, anthracite / plastique, blanc

L 190, H 270, A 80



1x 10W



1x

830lm



IP44



9 002759 980887



98087 CULPINA

wall light; aluminium, white / plastic, white
Wandleuchte; Alu, weiss / Kunststoff, weiss
applique; aluminium, blanc / plastique, blanc

L 190, H 270, A 80



1x 10W



1x

830lm



IP44



9 002759 980870



98088



97289 CORNALE

wall light; plastic, anthracite / plastic, white
 Wandleuchte; Kunststoff, anthrazit / Kunststoff, weiss
 applique; plastique, anthracite / plastique, blanc

L 215, H 215, A 70

1x 8,2W	1x			
	820lm			
IP44				

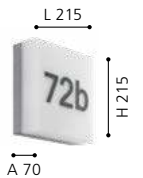

1x
A-F

3x
0-9

97289

Letters and numbers included in delivery.
 Buchstaben und Zahlen im Lieferumfang enthalten.
 Les lettres et les nombres sont inclus dans la livraison.

97289

Automatic illumination: This photoelectric lighting controller is used for controlling lighting systems for building fronts and automatically switches light 'ON' at dusk automatically 'OFF' again at dawn.

Automatische Beleuchtung: Der Day & Night Sensor dient zur Steuerung von Beleuchtungsanlagen an Hausfronten und schaltet bei Dämmerung automatisch Licht AN und am Morgen automatisch wieder AUS.

Un éclairage automatique : Le Interrupteur crépusculaire pour la commande des installations d'éclairage pour les façades de maison e il allume automatiquement la lumière au crépuscule et l'éteint automatiquement à l'aube.



1x 3x
A-F 0-9

98143

Letters and numbers included in delivery.

Buchstaben und Zahlen im Lieferumfang enthalten.

Les lettres et les nombres sont inclus dans la livraison.



98143 MONTEROS

wall light; aluminium, white / glass, plastic, clear, white
Wandleuchte; Alu, weiss / Glas, Kunststoff, klar, weiss
applique; aluminium, blanc / verre, plastique, clair, blanc

L 250, H 335, A 95



E27



1x 28W



IP44



A 95



L 250



9 002759 981433



98143





LED

99585 EREDITA

wall light; stainless steel, plastic, anthracite / satin glass, white
 Wandleuchte; Edelstahl, Kunststoff, anthrazit / Glas satiniert, weiss
 applique; acier inoxydable, plastique, anthracite / verre satiné, blanc

L 180, H 260, A 105



LED

GL3026

93438 NADELA

wall light; stainless steel, stainless steel / satin glass, white
 Wandleuchte; Edelstahl, edelstahl / Glas satiniert, weiss
 applique; acier inoxydable, acier inoxydable / verre satiné, blanc

L 215, H 290, A 90

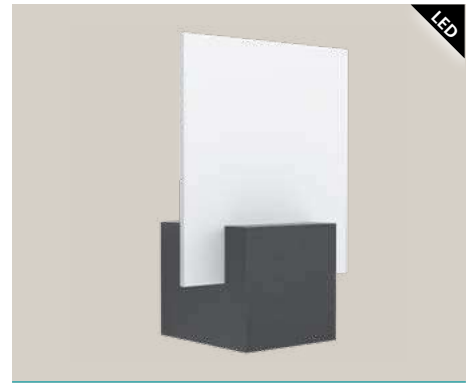

LED

98745 ADAMELLO

wall light; cast aluminium, black / satin glass, white
 Wandleuchte; Aluguss, schwarz / Glas satiniert, weiss
 applique; fonte d'aluminium, noir / verre satiné, blanc

L 200, H 280, A 130



98717



LED

93254 KIBEA

wall light; zinc-plated steel, white, anthracite
 Wandleuchte; Stahl verzinkt, weiss, anthrazit
 applique; acier galvanisé, blanc, anthracite

L 150, H 260, A 75



LED

98717 ALBENZA

wall light; cast aluminium, white, anthracite
 Wandleuchte; Aluguss, weiss, anthrazit
 applique; fonte d'aluminium, blanc, anthracite

L 200, H 300, A 95





95987



95988 SITIA

wall light; zinc-plated steel, anthracite / plastic, white
Wandleuchte; Stahl verzinkt, anthrazit / Kunststoff, weiss
applique; acier galvanisé, anthracite / plastique, blanc

L 180, H 180, A 55



2x 4,8W



2x
550lm



IP44



9 002759 959883

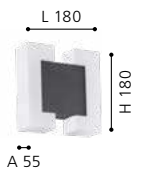

95987 SITIA

wall light; zinc-plated steel, satin nickel / plastic, white
Wandleuchte; Stahl verzinkt, nickel-matt / Kunststoff, weiss
applique; acier galvanisé, nickel mat / plastique, blanc

L 180, H 180, A 55



2x 4,8W



2x
550lm



IP44



9 002759 959876

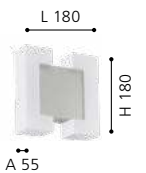



LED

93365 PIAS

wall light; stainless steel, stainless steel
Wandleuchte; Edelstahl, edelstahl
applique; acier inoxydable, acier inoxydable

L 150, H 250, A 55



9 002759 933654

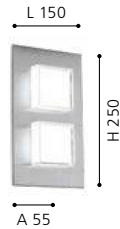

LED

94845 ACATE

wall / ceiling light; aluminium, steel, silver / plastic, white
Wand- / Deckenleuchte; Alu, Stahl, silber / Kunststoff, weiss
applique / plafonnier; aluminium, acier, argent / plastique, blanc

L 100, H 350, A 60



9 002759 948450

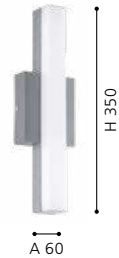

CRI >90



LED

94186 TABO

wall light; aluminium, silver
Wandleuchte; Alu, silber
applique; aluminium, argent

L 75, B 75, H 195, A 105



9 002759 941864



94114



LED

94114 CALGARY 1

wall light; stainless steel, stainless steel / plastic, white
Wandleuchte; Edelstahl, edelstahl / Kunststoff, weiss
applique; acier inoxydable, acier inoxydable / plastique, blanc

L 200, H 200, A 95



9 002759 941147





94086 RALORA

wall light; stainless steel, stainless steel / plastic, white
 Wandleuchte; Edelstahl, edelstahl / Kunststoff, weiss
 applique; acier inoxydable, acier inoxydable / plastique, blanc

L 140, H 240, A 70



3x 2,5W 3x 180lm



9 002759 940867

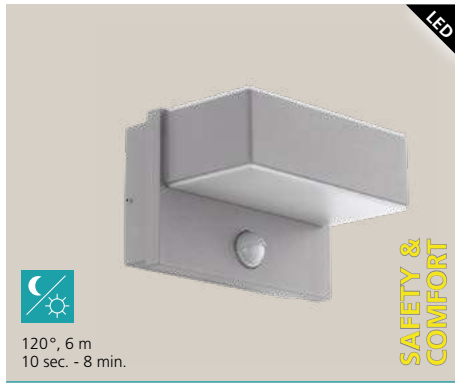

97159 AZZINANO

wall light; zinc-plated steel, silver / plastic, white
 Wandleuchte; Stahl verzinkt, silber / Kunststoff, weiss
 applique; acier galvanisé, argent / plastique, blanc

L 185, H 115, A 125



2x 5,6W 2x 640lm



9 002759 971595

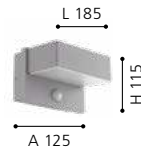

97159



96255



96256 JORBA

wall light; cast aluminium, anthracite / plastic, white
Wandleuchte; Aluguss, anthrazit / Kunststoff, weiss
applique; fonte d'aluminium, anthracite / plastique, blanc

L 110, H 110, A 110

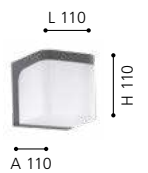

96255 JORBA

wall light; cast aluminium, white / plastic, white
Wandleuchte; Aluguss, weiss / Kunststoff, weiss
applique; fonte d'aluminium, blanc / plastique, blanc

L 110, H 110, A 110

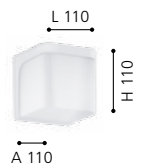



96007



96007 PERAFITA

wall light; cast aluminium, anthracite / plastic, white
Wandleuchte; Aluguss, anthrazit / Kunststoff, weiss
applique; fonte d'aluminium, anthracite / plastique, blanc

L 175, H 170, A 95



2x 6W



2x
500lm



IP44



9 002759 960070

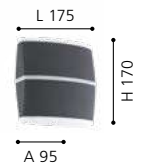



98233 FRANCARI

wall light; cast aluminium, anthracite / plastic, white
 Wandleuchte; Aluguss, anthrazit / Kunststoff, weiss
 applique; fonte d'aluminium, anthracite / plastique, blanc

L 220, H 275, A 225

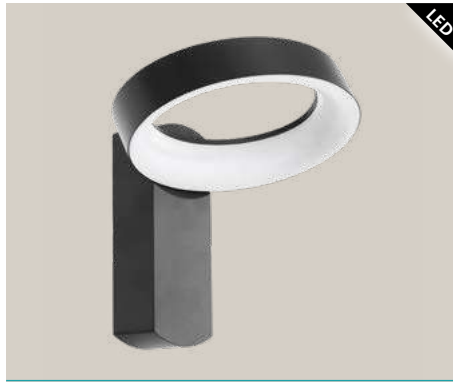
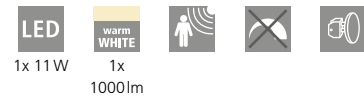

97307 PERNATE

wall light; cast aluminium, anthracite / plastic, white
 Wandleuchte; Aluguss, anthrazit / Kunststoff, weiss

applique; fonte d'aluminium, anthracite / plastique, blanc

L 250, H 235, A 170



97308 PERNATE

wall light; cast aluminium, anthracite / plastic, white
 Wandleuchte; Aluguss, anthrazit / Kunststoff, weiss

applique; fonte d'aluminium, anthracite / plastique, blanc

L 250, H 235, A 170



94779 BOSARO

wall light; stainless steel, stainless steel
 Wandleuchte; Edelstahl, edelstahl
 applique; acier inoxydable, acier inoxydable

L 170, H 270, A 105





97308



LED

93368 REDONDO

wall light; cast aluminium, anthracite
Wandleuchte; Aluguss, anthrazit
applique; fonte d'aluminium, anthracite

L 160, H 175, A 125



2x 2,5W 2x 180lm



IP44



9 002759 933685



LED

93319 MORINO

wall light; cast aluminium, anthracite
Wandleuchte; Aluguss, anthrazit
applique; fonte d'aluminium, anthracite

L 140, H 180, A 105



2x 2,5W 2x 180lm



IP44



9 002759 933197

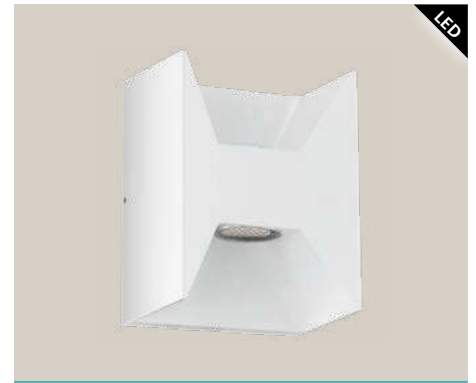
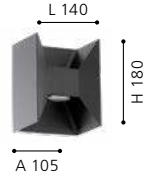

LED

93318 MORINO

wall light; cast aluminium, white
Wandleuchte; Aluguss, weiss
applique; fonte d'aluminium, blanc

L 140, H 180, A 105



2x 2,5W 2x 180lm



IP44



9 002759 933180

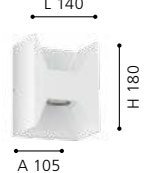

LED

97222 GORZANO

wall light; zinc-plated steel, anthracite / plastic, satined
Wandleuchte; Stahl verzinkt, anthrazit / Kunststoff, satiniert
applique; acier galvanisé, anthracite / plastique, satiné

L 80, H 290, A 105



1x 4,8W 500lm



9 002759 972226

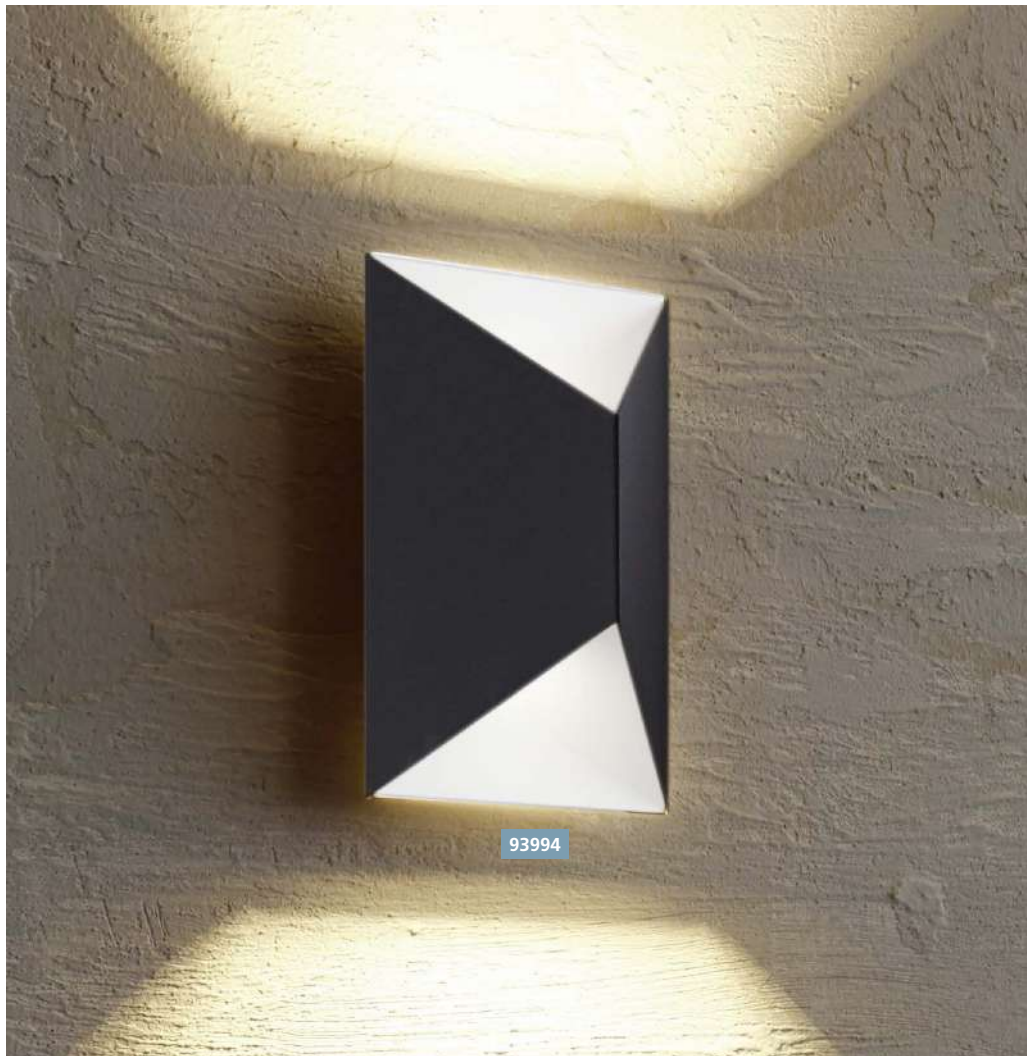

93994

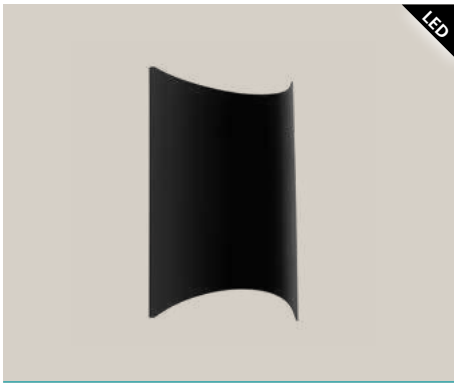

98736 LAGASCO

wall light; zinc-plated steel, black
 Wandleuchte; Stahl verzinkt, schwarz
 applique; acier galvanisé, noir

L 185, H 275, A 85



93994 PREDAZZO

wall light; zinc-plated steel, anthracite, white
 Wandleuchte; Stahl verzinkt, anthrazit, weiss
 applique; acier galvanisé, anthracite, blanc

L 140, H 210, A 75



98736



96013 ROBLEDO

wall light; stainless steel, stainless steel / plastic, transparent
 Wandleuchte; Edelstahl, edelstahl / Kunststoff, transparent
 applique; acier inoxydable, acier inoxydable / plastique, transparent

L 75, H 260, A 120

LED
 2x 3,7W
 warm WHITE
 2x
 320lm
 IP44



9 002759 960131



86541 BEVERLY

wall light; stainless steel, stainless steel, silver / satin glass, white
 Wandleuchte; Edelstahl, edelstahl, silber / Glas satiniert, weiss
 applique; acier inoxydable, acier inoxydable, argent / verre satiné, blanc

L 200, H 350, A 135

E27
 2x 60W
 IP44



9 002759 865412



93268 STOCKHOLM 1

wall light; stainless steel, stainless steel / glass, clear
 Wandleuchte; Edelstahl, edelstahl / Glas, klar
 applique; acier inoxydable, acier inoxydable / verre, clair

Ø 100

GU10
 1x 5W
 warm WHITE
 1x
 400lm
 IP44



9 002759 932688





94127 TRONO STICK

wall light; stainless steel, stainless steel / glass, plastic, clear
 Wandleuchte; Edelstahl, edelstahl / Glas, Kunststoff, klar
 applique; acier inoxydable, acier inoxydable / verre, plastique, clair

L 105, H 350, A 115

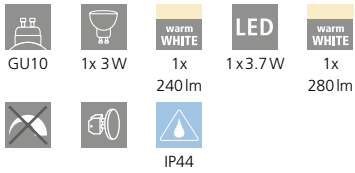

94128 TRONO STICK

wall light; stainless steel, stainless steel / glass, plastic, clear
 Wandleuchte; Edelstahl, edelstahl / Glas, Kunststoff, klar
 applique; acier inoxydable, acier inoxydable / verre, plastique, clair

L 105, H 410, A 175

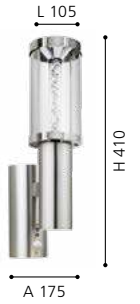

98741 FANTECOLO

wall light; stainless steel, stainless steel / glass, clear
 Wandleuchte; Edelstahl, edelstahl / Glas, klar
 applique; acier inoxydable, acier inoxydable / verre, clair

L 100, H 200, A 145





94803



94804 AGOLADA

wall light; zinc-plated steel, black, copper
Wandleuchte; Stahl verzinkt, schwarz, kupfer
applique; acier galvanisé, noir, cuivre

L 75, H 360, A 110



2x 3,7W



2x
320lm



IP44



9 002759 948047



94803 AGOLADA

wall light; stainless steel, stainless steel, white
Wandleuchte; Edelstahl, edelstahl, weiss
applique; acier inoxydable, acier inoxydable, blanc

L 75, H 360, A 110



2x 3,7W



2x
320lm



IP44



9 002759 948030



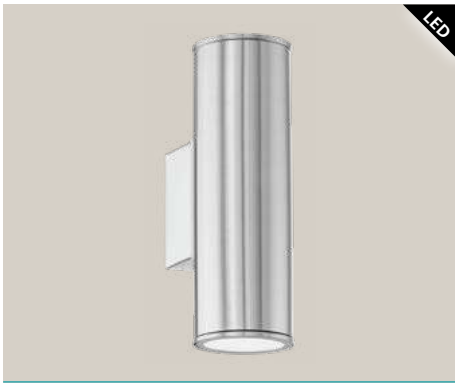

94107 RIGA

wall light; stainless steel, stainless steel
Wandleuchte; Edelstahl, edelstahl
applique; acier inoxydable, acier inoxydable

L 65, H 200, A 95

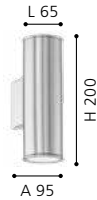
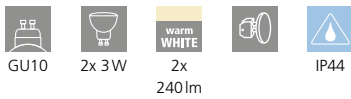

94103 RIGA

wall light; zinc-plated steel, anthracite
Wandleuchte; Stahl verzinkt, anthrazit
applique; acier galvanisé, anthracite

L 65, H 200, A 95

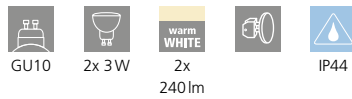

94105 RIGA

wall light; zinc-plated steel, antique-brown
Wandleuchte; Stahl verzinkt, antik-braun
applique; acier galvanisé, marron antique

L 65, H 200, A 95

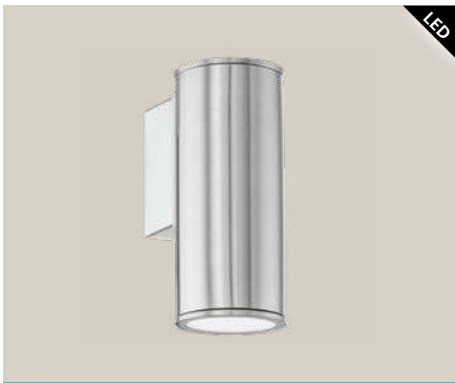
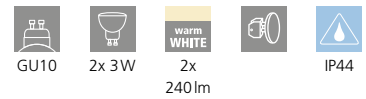

94106 RIGA

wall light; stainless steel, stainless steel
Wandleuchte; Edelstahl, edelstahl
applique; acier inoxydable, acier inoxydable

L 65, H 150, A 95



94102 RIGA

wall light; zinc-plated steel, anthracite
Wandleuchte; Stahl verzinkt, anthrazit
applique; acier galvanisé, anthracite

L 65, H 150, A 95

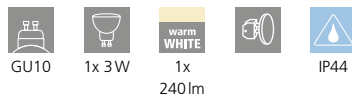

94101 RIGA

wall light; zinc-plated steel, white
Wandleuchte; Stahl verzinkt, weiss
applique; acier galvanisé, blanc

L 65, H 200, A 95





97119 TONEGO

wall light; zinc-plated steel, anthracite / plastic, white
 Wandleuchte; Stahl verzinkt, anthrazit / Kunststoff, weiss
 applique; acier galvanisé, anthracite / plastique, blanc

L 75, H 310, A 100

LED
 2x 6W
 warm WHITE
 2x
 500lm
 IP44



9 002759 971199



92736 RIGA-LED

wall light; stainless steel, stainless steel / plastic, satiné
 Wandleuchte; Edelstahl, edelstahl / Kunststoff, satiniert
 applique; acier inoxydable, acier inoxydable / plastique, satiné

L 65, H 205, A 95

GU10
 2x 3W
 neutral WHITE
 2x
 200lm
 IP44



9 002759 927363



96505 RIGA-LED

wall light; zinc-plated steel, black / plastic, satiné
 Wandleuchte; Stahl verzinkt, schwarz / Kunststoff, satiniert
 applique; acier galvanisé, noir / plastique, satiné

L 65, H 205, A 100

GU10
 2x 5W
 neutral WHITE
 2x
 400lm
 IP44



9 002759 965051



97119



99569 RIGA 5

wall light; stainless steel, stainless steel / glass, clear
 Wandleuchte; Edelstahl, edelstahl / Glas, klar
 applique; acier inoxydable, acier inoxydable / verre, clair

L 65, H 165, A 110

GU10
 1x 3W
 warm WHITE 1x 240lm

IP44

9 002759 995690

INCL



32898 RIGA 5

wall light; stainless steel, stainless steel / glass, clear
 Wandleuchte; Edelstahl, edelstahl / Glas, klar
 applique; acier inoxydable, acier inoxydable / verre, clair

L 65, H 215, A 110

GU10
 2x 3W
 warm WHITE 2x 240lm

IP44

9 002759 328986

INCL



32899 RIGA 5

wall light; zinc-plated steel, anthracite / glass, clear
 Wandleuchte; Stahl verzinkt, anthrazit / Glas, klar
 applique; acier galvanisé, anthracite / verre, clair

L 65, H 215, A 110

GU10
 2x 3W
 warm WHITE 2x 240lm

IP44

9 002759 328993

INCL



99571 RIGA 5

wall light; zinc-plated steel, black / glass, clear
 Wandleuchte; Stahl verzinkt, schwarz / Glas, klar
 applique; acier galvanisé, noir / verre, clair

L 65, H 165, A 110

GU10
 1x 3W
 warm WHITE 1x 240lm

IP44

9 002759 995713

INCL





96276



96276 ATOLLARI

wall light; cast aluminium, anthracite / plastic, white
 Wandleuchte; Aluguss, anthrazit / Kunststoff, weiss
 applique; fonte d'aluminium, anthracite / plastique, blanc

L 100, H 230, A 155

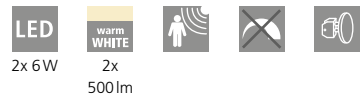

96277 ATOLLARI

wall light; cast aluminium, stainless steel, silver / plastic, white
 Wandleuchte; Aluguss, edelstahl, silber / Kunststoff, weiss
 applique; fonte d'aluminium, acier inoxydable, argent / plastique, blanc

L 100, H 230, A 155





98086 CISTIerna

wall light; zinc-plated steel, anthracite / plastic, white
Wandleuchte; Stahl verzinkt, anthrazit / Kunststoff, weiss
applique; acier galvanisé, anthracite / plastique, blanc

L 180, H 350, A 90



98085 CISTIerna

wall light; stainless steel, stainless steel / plastic, white
Wandleuchte; Edelstahl, edelstahl / Kunststoff, weiss
applique; acier inoxydable, acier inoxydable / plastique, blanc

L 180, H 350, A 90

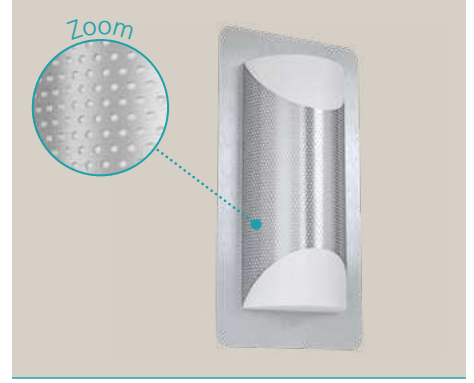

98716 CISTIerna 1

wall light; stainless steel, stainless steel / plastic, white
Wandleuchte; Edelstahl, edelstahl / Kunststoff, weiss
applique; acier inoxydable, acier inoxydable / plastique, blanc

L 180, H 350, A 90

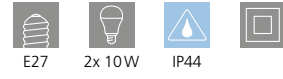

98086





96021 SESIMBA 1

wall light; zinc-plated steel, black / plastic, clear
Wandleuchte; Stahl verzinkt, schwarz / Kunststoff, klar
applique; acier galvanisé, noir / plastique, clair

L 130, H 195, A 140

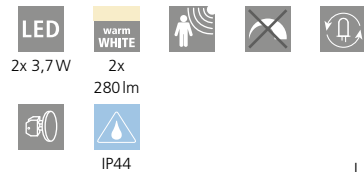

96019 SESIMBA 1

wall light; zinc-plated steel, silver / plastic, clear
Wandleuchte; Stahl verzinkt, silber / Kunststoff, klar
applique; acier galvanisé, argent / plastique, clair

L 130, H 195, A 140



96022 SESIMBA 1

wall light; zinc-plated steel, white / plastic, clear
Wandleuchte; Stahl verzinkt, weiss / Kunststoff, klar
applique; acier galvanisé, blanc / plastique, clair

L 130, H 195, A 140

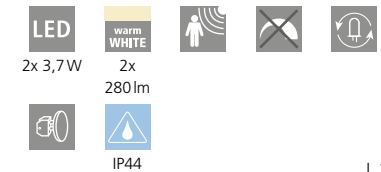

94848 SESIMBA

wall light; zinc-plated steel, black / plastic, clear
Wandleuchte; Stahl verzinkt, schwarz / Kunststoff, klar
applique; acier galvanisé, noir / plastique, clair

L 130, H 195, A 140

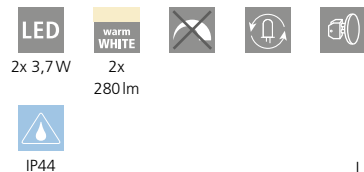

94796 SESIMBA

wall light; zinc-plated steel, silver / plastic, clear
Wandleuchte; Stahl verzinkt, silber / Kunststoff, klar
applique; acier galvanisé, argent / plastique, clair

L 130, H 195, A 140

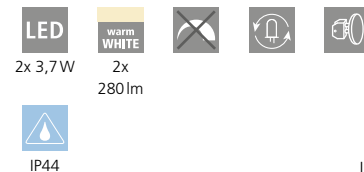



96022



98706 TREVILO 1

wall light; cast aluminium, black / plastic, white
 Wandleuchte; Aluguss, schwarz / Kunststoff, weiss
 applique; fonte d'aluminium, noir / plastique, blanc

L 160, H 85, A 190



98746 TREVILO

wall light; cast aluminium, anthracite / glass, clear
 Wandleuchte; Aluguss, anthrazit / Glas, klar
 applique; fonte d'aluminium, anthracite / verre, clair

L 90, H 85, A 120



98747 TREVILO

wall light; cast aluminium, white / glass, clear
 Wandleuchte; Aluguss, weiss / Glas, klar
 applique; fonte d'aluminium, blanc / verre, clair

L 90, H 85, A 120



98746



98711



98711 CHINOA

wall light; aluminium, steel, anthracite / plastic, transparent
Wandleuchte; Alu, Stahl, anthrazit / Kunststoff, transparent
applique; aluminium, acier, anthracite / plastique, transparent

L 270, H 75, A 135



10W 1100lm



98709 CHINOA

wall light; aluminium, steel, white / plastic, transparent
Wandleuchte; Alu, Stahl, weiss / Kunststoff, transparent
applique; aluminium, acier, blanc / plastique, transparent

L 270, H 75, A 135



10W 1100lm



98729 PASSIRANO

wall light; cast aluminium, black, white / plastic, transparent
Wandleuchte; Aluguss, schwarz, weiss / Kunststoff, transparent
applique; fonte d'aluminium, noir, blanc / plastique, transparent

L 240, H 120, A 110



4,8W 500lm





90°, 7 m
10 sec. - 4 min.

**SAFETY &
COMFORT**

97238 VERRES

wall light; stainless steel, plastic, stainless steel, white / plastic, white

Wandleuchte; Edelstahl, Kunststoff, edelstahl, weiss / Kunststoff, weiss

applique; acier inoxydable, plastique, acier inoxydable, blanc / plastique, blanc

L 180, H 290, A 90



E27 1x 12W IP44



9 002759 972387



GL-803

83433 PARK

wall light; cast aluminium, anthracite / satin glass, white

Wandleuchte; Aluguss, anthrazit / Glas satiniert, weiss

applique; fonte d'aluminium, anthracite / verre satiné, blanc

L 200, H 350, A 145



E27 1x 60W IP44



9 002759 834333



LED

94138 BREGANZO

wall light; zinc-plated steel, anthracite / plastic, white

Wandleuchte; Stahl verzinkt, anthrazit / Kunststoff, weiss

applique; acier galvanisé, anthracite / plastique, blanc

L 180, H 250, A 115



LED warm WHITE 2x 2,5W 180lm IP44



9 002759 941383



180°, 7 m
10 sec. - 15 min.

**SAFETY &
COMFORT**

97218 MUSSOTTO

wall light; stainless steel, plastic, stainless steel, white / plastic, white

Wandleuchte; Edelstahl, Kunststoff, edelstahl, weiss / Kunststoff, weiss

applique; acier inoxydable, plastique, acier inoxydable, blanc / plastique, blanc

L 210, H 305, A 90



E27 1x 28W IP44



9 002759 972189



90°, 6 m
10 sec. - 10 min.

**SAFETY &
COMFORT**

96018 BREGANZO 1

wall light; zinc-plated steel, anthracite / plastic, white

Wandleuchte; Stahl verzinkt, anthrazit / Kunststoff, weiss

applique; acier galvanisé, anthracite / plastique, blanc

L 190, H 300, A 125



LED warm WHITE 2x 2,5W 180lm IP44



9 002759 960186



90°, 6 m
10 sec. - 10 min.

**SAFETY &
COMFORT**

96017 BREGANZO 1

wall light; zinc-plated steel, silver / plastic, white

Wandleuchte; Stahl verzinkt, silber / Kunststoff, weiss

applique; acier galvanisé, argent / plastique, blanc

L 190, H 300, A 125



LED warm WHITE 2x 2,5W 180lm IP44



9 002759 960179





96017



30192



180°, 6 m
10 sec. - 15 min.

**SAFETY &
COMFORT**

97284 TRIBANO

wall light; zinc-plated steel, stainless steel / plastic, transparent
Wandleuchte; Stahl verzinkt, edelstahl / Kunststoff, transparent
applique; acier galvanisé, acier inoxydable / plastique, transparent

L 200, H 260, A 100



E27



1x 60W



IP44



L 200



H 260

A 100



9 002759 972844





30192 CERNO

wall light; stainless steel, stainless steel / satin glass, white
 Wandleuchte; Edelstahl, edelstahl / Glas satiniert, weiss
 applique; acier inoxydable, acier inoxydable / verre satiné, blanc

L 140, H 190, A 110

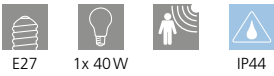

88144 CITY

wall light; stainless steel, stainless steel / plastic, white
 Wandleuchte; Edelstahl, edelstahl / Kunststoff, weiss
 applique; acier inoxydable, acier inoxydable / plastique, blanc

L 235, H 260, A 90

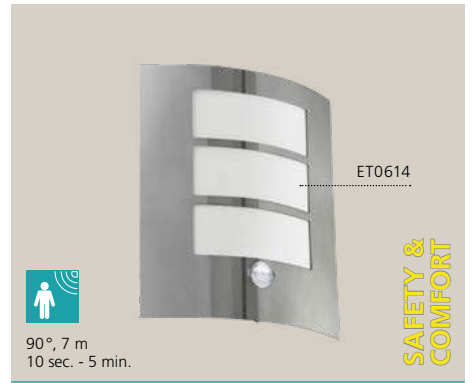

88142 CITY

wall light; stainless steel, stainless steel / plastic, white
 Wandleuchte; Edelstahl, edelstahl / Kunststoff, weiss
 applique; acier inoxydable, acier inoxydable / plastique, blanc

L 235, H 260, A 90



30191 CERNO

wall light; stainless steel, stainless steel / satin glass, white
 Wandleuchte; Edelstahl, edelstahl / Glas satiniert, weiss
 applique; acier inoxydable, acier inoxydable / verre satiné, blanc

L 140, H 165, A 105



82309 CITY

wall light; stainless steel, stainless steel / plastic, white
 Wandleuchte; Edelstahl, edelstahl / Kunststoff, weiss
 applique; acier inoxydable, acier inoxydable / plastique, blanc

L 235, H 260, A 90



88139 CITY

wall light; stainless steel, stainless steel / plastic, white
 Wandleuchte; Edelstahl, edelstahl / Kunststoff, weiss
 applique; acier inoxydable, acier inoxydable / plastique, blanc

L 235, H 260, A 90

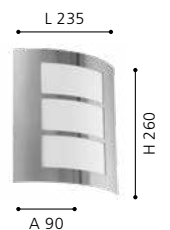
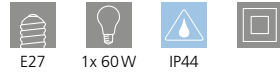



98718 DARIL 1

wall light; zinc-plated steel, black / plastic, transparent
Wandleuchte; Stahl verzinkt, schwarz / Kunststoff, transparent
applique; acier galvanisé, noir / plastique, transparent

L 195, H 240, A 110



E27



1x 28W



IP44



9 002759 987183





99565 CERNO

wall light; zinc-plated steel, black / satin glass, white
Wandleuchte; Stahl verzinkt, schwarz / Glas satiniert, weiss
applique; acier galvanisé, noir / verre satiné, blanc

L 140, H 165, A 105



99566 CERNO

wall light; zinc-plated steel, black / satin glass, white
Wandleuchte; Stahl verzinkt, schwarz / Glas satiniert, weiss
applique; acier galvanisé, noir / verre satiné, blanc

L 140, H 200, A 110

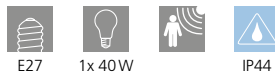

**SAFETY &
COMFORT**

90°, 7 m
10 sec. - 4 min.



99567 CITY

wall light; zinc-plated steel, black / plastic, white
Wandleuchte; Stahl verzinkt, schwarz / Kunststoff, weiss
applique; acier galvanisé, noir / plastique, blanc

L 235, H 260, A 90

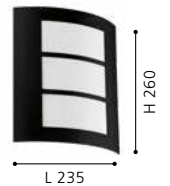
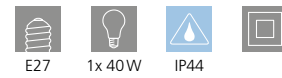

99568 CITY

wall light; zinc-plated steel, black / plastic, white
Wandleuchte; Stahl verzinkt, schwarz / Kunststoff, weiss
applique; acier galvanisé, noir / plastique, blanc

L 235, H 260, A 110

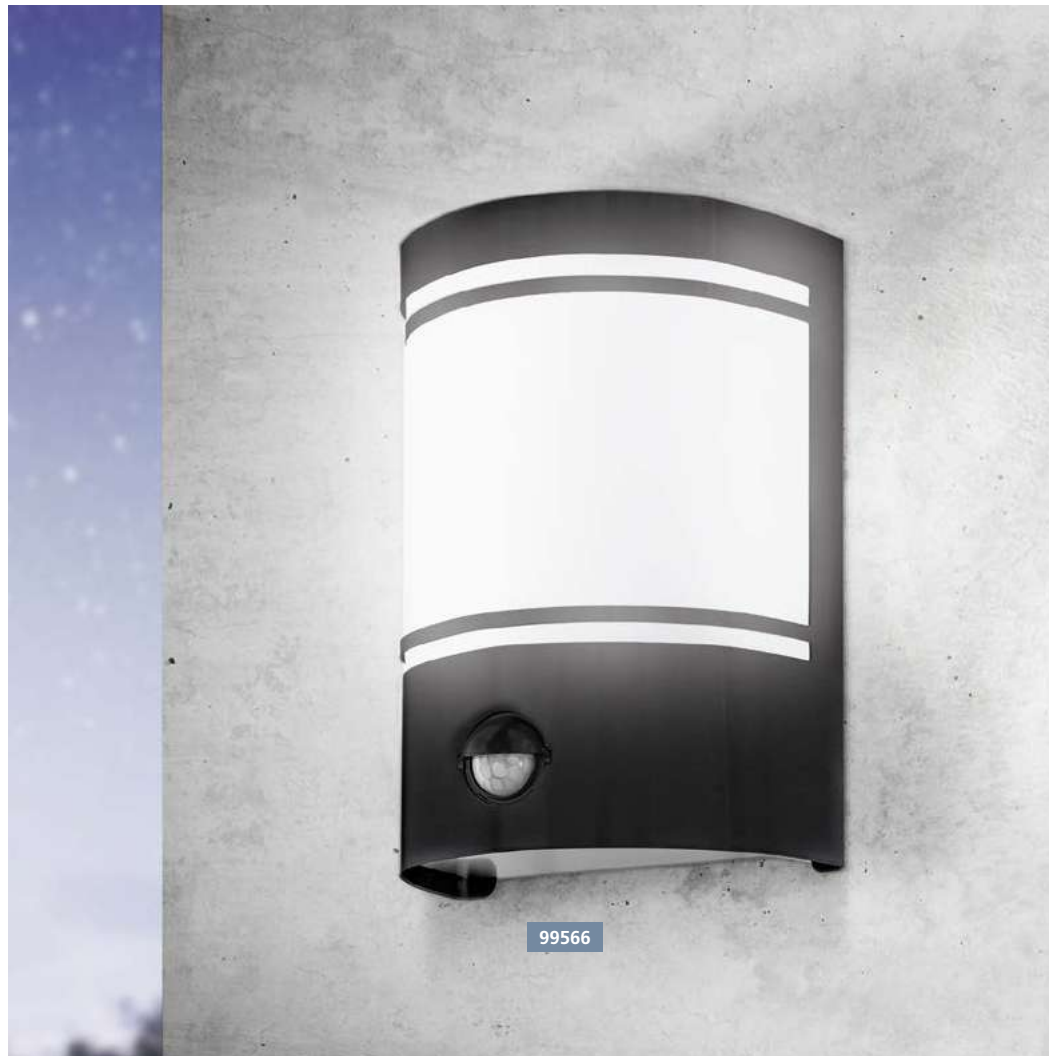

99566



89768 ONJA

wall light; cast aluminium, white / glass fluted, clear
Wandleuchte; Aluguss, weiss / Glas geriffelt, klar
applique; fonte d'aluminium, blanc / verre cannelé, clair

L 220, H 155, A 150

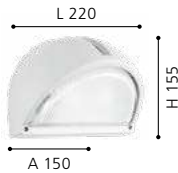

89767 ONJA

wall light; cast aluminium, black / glass fluted, clear
Wandleuchte; Aluguss, schwarz / Glas geriffelt, klar
applique; fonte d'aluminium, noir / verre cannelé, clair

L 220, H 155, A 150



90867 LEPUS

wall light; steel, zinc-plated / plastic, white
Wandleuchte; Stahl, feuerverzinkt / Kunststoff, weiss
applique; acier, galvanisé à chaud / plastique, blanc

L 235, H 120, A 125



89768

ONJA

With direct and indirect light this luminaire creates a spectacular effect.

Diese Leuchten schaffen durch direktes und indirektes Licht einen tollen Effekt.

Ce luminaire crée un effet lumineux special pour une illumination directe et indirecte.



96206 ENTRIMO

wall light; zinc-plated steel, zinc-plated / plastic, white
Wandleuchte; Stahl verzinkt, feuerverzinkt / Kunststoff, weiss
applique; acier galvanisé, galvanisé à chaud / plastique, blanc

L 200, H 185, A 235

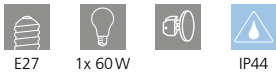

88119 SEVILLA

wall / ceiling light; steel, zinc-plated / satin glass, white
Wand- / Deckenleuchte; Stahl, feuerverzinkt / Glas satiniert, weiss

applique / plafonnier; acier, galvanisé à chaud / verre satiné, blanc

Ø 285, A 83



88489, 88119, 96206, 90867

15 years guarantee against corrosion on the hot dipped galvanized surface.

15 Jahre Garantie gegen Korrosion der feuerverzinkten Oberfläche.

Garantie de 15 ans contre la corrosion de la surface galvanisée à chaud.



88489 MILTON

wall light; steel, zinc-plated / glass, clear
Wandleuchte; Stahl, feuerverzinkt / Glas, klar
applique; acier, galvanisé à chaud / verre, clair

H 310, A 310

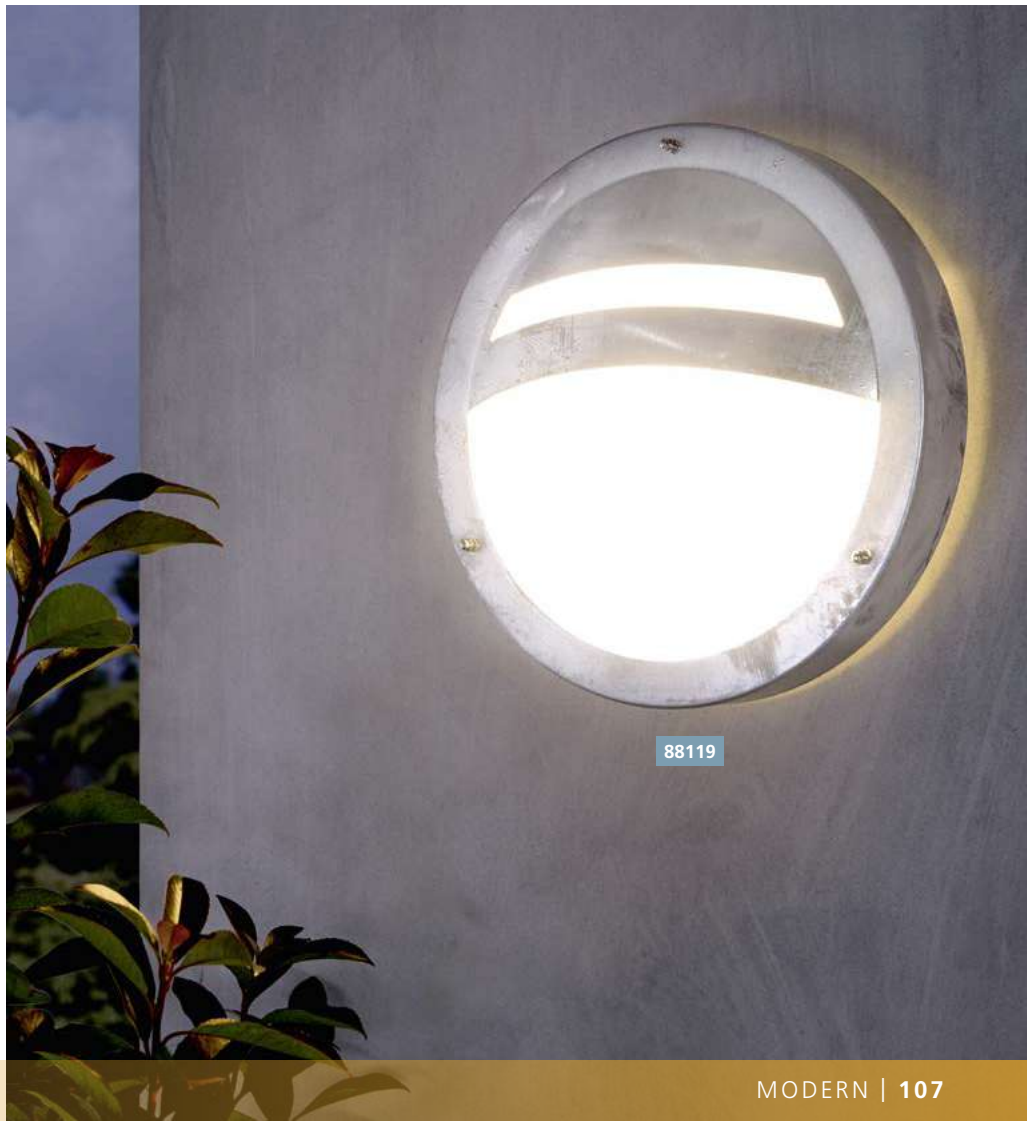
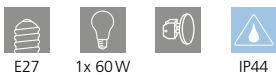

88119

TOPLINE

TOPLINE - Purist design and high quality materials characterize the exterior lighting program for extraordinary expectations. We are supporting the architecture that creates wellness spaces. Treat yourself to the topline of EGLO.

TOPLINE - Puristisches Design und Hochwertigkeit der Materialien zeichnen das Außenleuchten-Programm für gehobene Ansprüche besonders aus. Wir setzen damit Akzente für die Architektur des Wohlfühl-Raums. Gönnen Sie sich die Topline von EGLO.



TOPLINE - Conception puriste et matériaux de haute qualité caractérisent le programme d'éclairage extérieur pour les clients avec des attentes élevées. Nous avons donc donné le ton pour l'architecture de l'espace bien-être. Offrez-vous la Topline de EGLO.



OVERVIEW

TOPLINE





SAKEDA
112



SAKEDA
112



SAKEDA
112



IPHIAS
113



IPHIAS
113



CALPINO
114



CALPINO
114



DESELLA 1
115



BELCREDA
116



BELCREDA
116



EMOLLIO
117



BEVERLY 1
118



BRIONES
118



CHEIRA
118

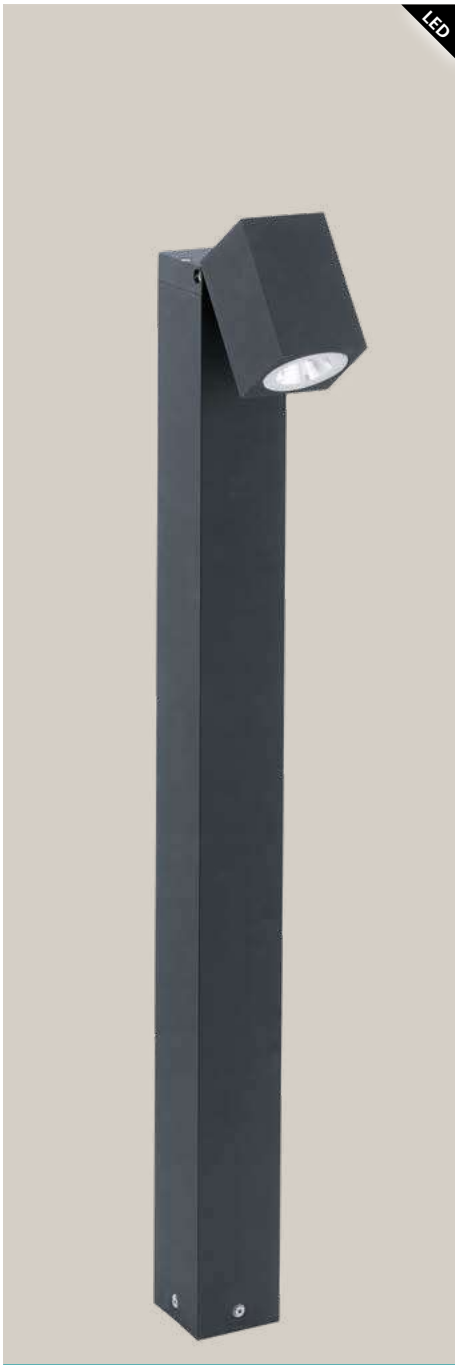

96288 SAKEDA

floor light; cast aluminium, anthracite
 Stehleuchte; Aluguss, anthrazit
 lampadaire; fonte d'aluminium, anthracite

L 135, B 70, H 780, Base: B 70, T 70

- LED 1x 5W
- warm WHITE 1x 650lm
- IP44



9 002759 962883

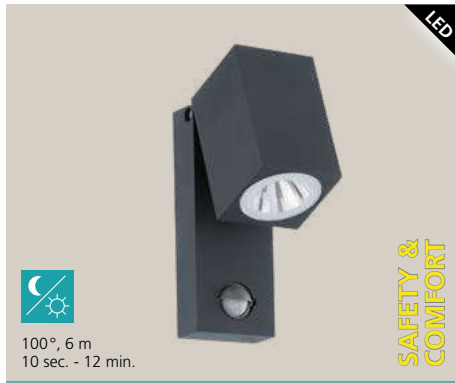

100°, 6 m
 10 sec. - 12 min.

**SAFETY &
 COMFORT**

96287 SAKEDA

wall light; cast aluminium, anthracite
 Wandleuchte; Aluguss, anthrazit
 applique; fonte d'aluminium, anthracite

L 70, H 170, A 100

- LED 1x 5W
- warm WHITE 1x 650lm
- IP44



9 002759 962876



96286 SAKEDA

wall light; cast aluminium, anthracite
 Wandleuchte; Aluguss, anthrazit
 applique; fonte d'aluminium, anthracite

L 70, H 170, A 100

- LED 1x 5W
- warm WHITE 1x 650lm
- IP44



9 002759 962869



96286



96488

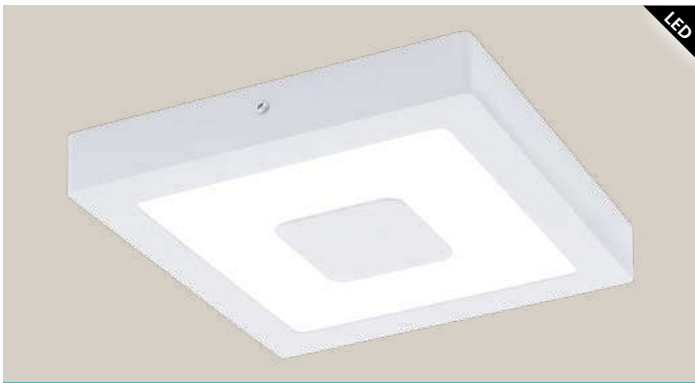

96488 IPHIAS

wall / ceiling light; cast aluminium, white / plastic, white
 Wand- / Deckenleuchte; Aluguss, weiss / Kunststoff, weiss
 applique / plafonnier; fonte d'aluminium, blanc / plastique, blanc

L 225, B 225, H 40



16,5W 1700lm

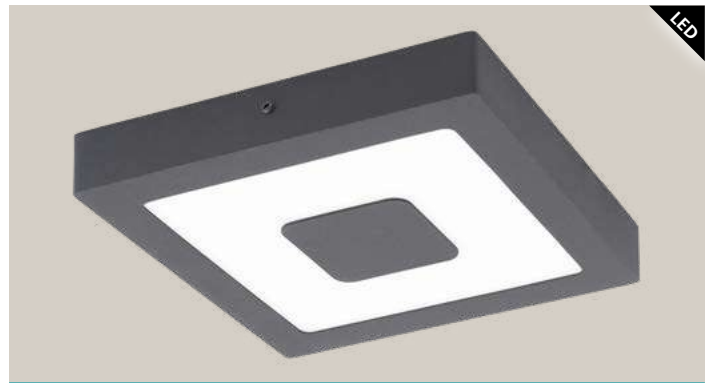

96489 IPHIAS

wall / ceiling light; cast aluminium, anthracite / plastic, white
 Wand- / Deckenleuchte; Aluguss, anthrazit / Kunststoff, weiss
 applique / plafonnier; fonte d'aluminium, anthracite / plastique, blanc

L 225, B 225, H 40



16,5W 1700lm

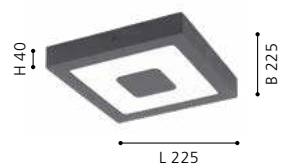



97241 CALPINO

wall light; cast aluminium, white
 Wandleuchte; Aluguss, weiss
 applique; fonte d'aluminium, blanc

L 105, H 105, A 110

LED
 2x 3,3W
 warm WHITE
 2x
 340lm
 IP54



9 002759 972417

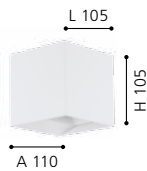

97241



97242 CALPINO

wall light; cast aluminium, anthracite
 Wandleuchte; Aluguss, anthrazit
 applique; fonte d'aluminium, anthracite

L 105, H 105, A 110

LED
 2x 3,3W
 warm WHITE
 2x
 340lm
 IP54



9 002759 972424

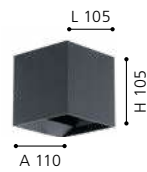



95097 DESELLA 1

wall light; cast aluminium, anthracite / plastic, white
Wandleuchte; Aluguss, anthrazit / Kunststoff, weiss
applique; fonte d'aluminium, anthracite / plastique, blanc

L 160, H 160, A 190

LED

10W

warm
WHITE

900lm



IP54





97312 BELCREDA

wall light; cast aluminium, anthracite / plastic, white
 Wandleuchte; Aluguss, anthrazit / Kunststoff, weiss
 applique; fonte d'aluminium, anthracite / plastique, blanc

L 330, H 125, A 165

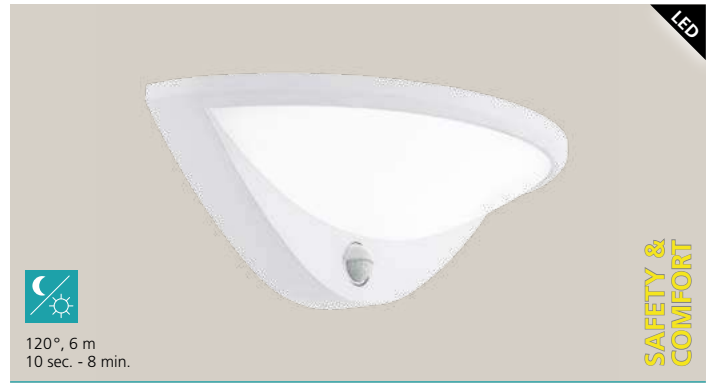
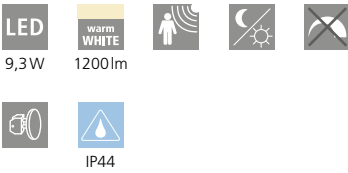

97311 BELCREDA

wall light; cast aluminium, white / plastic, white
 Wandleuchte; Aluguss, weiss / Kunststoff, weiss
 applique; fonte d'aluminium, blanc / plastique, blanc

L 330, H 125, A 165

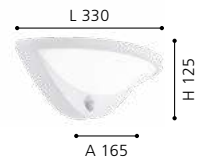
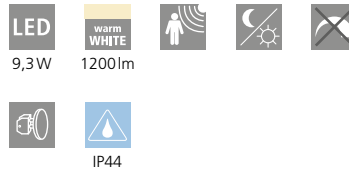



96274 EMOLLIO

wall light; cast aluminium, white / plastic, white
Wandleuchte; Aluguss, weiss / Kunststoff, weiss
applique; fonte d'aluminium, blanc / plastique, blanc

L 200, H 160, A 80

LED

10W

warm
WHITE

1000lm



IP44



9 002759 962746

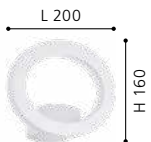



94799 BEVERLY 1

wall light; stainless steel, stainless steel / plastic, white, clear
 Wandleuchte; Edelstahl, edelstahl / Kunststoff, weiss, klar
 applique; acier inoxydable, acier inoxydable / plastique, blanc, clair

L 200, H 270, A 130

LED
 2x 3,7W
 warm WHITE
 2x
 280lm
 IP44



9 002759 947996



95079 BRIONES

wall light; cast aluminium, stainless steel / plastic, white
 Wandleuchte; Aluguss, edelstahl / Kunststoff, weiss
 applique; fonte d'aluminium, acier inoxydable / plastique, blanc

L 85, H 95, A 125

LED
 2x 3W
 warm WHITE
 500lm
 IP44



9 002759 950798

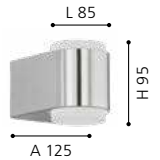

94799



97297 CHEIRA

wall light; cast aluminium, silver / plastic, white
 Wandleuchte; Aluguss, silber / Kunststoff, weiss
 applique; fonte d'aluminium, argent / plastique, blanc

L 295, H 300, A 60

LED
 2x 2,7W
 warm WHITE
 2x
 300lm
 LED
 1x 3,6W
 warm WHITE
 1x
 430lm
 IP44



9 002759 972974

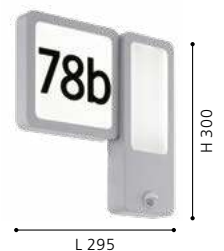

SAFETY & COMFORT



97297



CLASSIC

KLASSIK
CLASSIQUE

TIMELESS CLASSICS - Romantic and nostalgic elements from different materials create unique luminaires for your outdoor area. True classics for a real wellness ambience.

ZEITLOSE KLASSIKER - Romantische und nostalgische Elemente aus unterschiedlichen Materialien kreieren einzigartige Leuchten für Ihren Außenbereich. Wahre Klassiker für echtes Wohlfühlambiente.

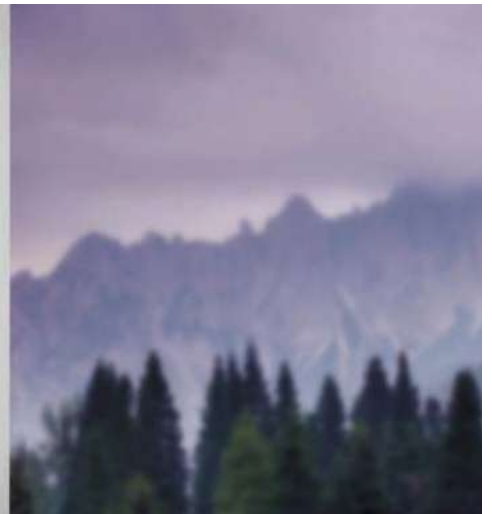

CLASSIQUE INTEMPOREL - Des éléments romantiques et nostalgiques issus de différents matériaux forment d' uniques luminaires pour votre extérieur. De véritables classiques pour une vraie ambiance de bien-être.



OVERVIEW

CLASSIC





VILLAGRAZIA
124



CASCINETTA
125



ALAMONTE 1
126



ALAMONTE
126



SONCINO
128



MIRANDOLA
128



CIVIDINO
129



RAVELLO
130



SIRMIONE
132



SIDNEY
134



LISIO
135



SOSSANO
136



TAVERNA
136



HILBURN
138



HILBURN 1
138



MELGOA
140



BARROSELA
140



PULFERO
140



CANOVE
140



PULFERO 1
143



MILTON
142



SAN TELMO
143



VALDEO
143



ALBACETE
143



BOVOLONE
144



TREKATE
144



MONREALE
146



ALORIA
150



ALORIA
152



NAVEDO
154



NAVEDO
157



MANERBIO
158



LATERNA 4
160



LATERNA 5
162

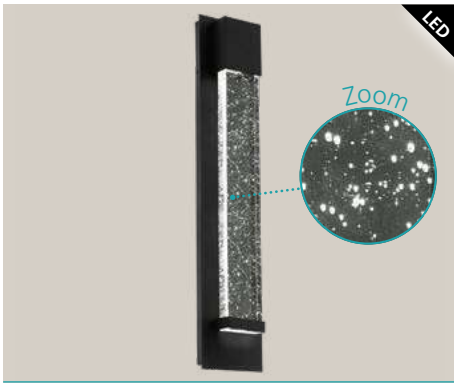

98154 VILLAGRAZIA

wall light; aluminium, black / glass with air inclusions, clear
 Wandleuchte; Alu, schwarz / Glas mit Lufteinschlüssen, klar
 applique; aluminium, noir / verre avec inclusions d'air, clair

L 120, H 400, A 70



2x 3,3W



2x
340lm



IP44

L 120



H 400



9 002759 981549

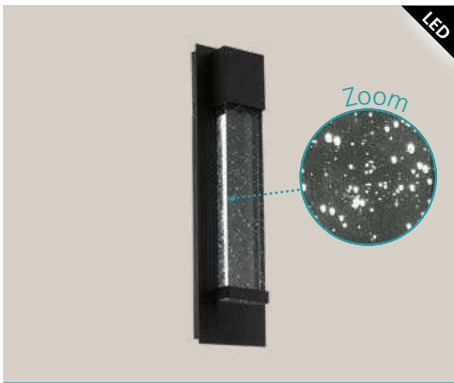

98153 VILLAGRAZIA

wall light; aluminium, black / glass with air inclusions, clear
 Wandleuchte; Alu, schwarz / Glas mit Lufteinschlüssen, klar
 applique; aluminium, noir / verre avec inclusions d'air, clair

L 120, H 300, A 70



2x 3,3W



2x
340lm



IP44

L 120



H 300



9 002759 981532





98715 CASCINETTA

floor light; cast aluminium, black / glass, clear
 Stehleuchte; Aluguss, schwarz / Glas, klar
 lampadaire; fonte d'aluminium, noir / verre, clair

L 150, B 150, H 795



98713 CASCINETTA

wall light; zinc-plated steel, black / glass, clear
 Wandleuchte; Stahl verzinkt, schwarz / Glas, klar
 applique; acier galvanisé, noir / verre, clair

L 165, H 280, A 165



98714 CASCINETTA

pedestal light; cast aluminium, black / glass, clear
 Sockelleuchte; Aluguss, schwarz / Glas, klar
 luminaire pour socle; fonte d'aluminium, noir / verre, clair

L 150, H 305, A 150





94833 ALAMONTE 1

floor light; zinc-plated steel, black / glass, clear
 Stehleuchte; Stahl verzinkt, schwarz / Glas, klar
 lampadaire; acier galvanisé, noir / verre, clair

L 150, B 150, H 1015, Base: Ø 110



94831 ALAMONTE 1

wall light; zinc-plated steel, black / glass, clear
 Wandleuchte; Stahl verzinkt, schwarz / Glas, klar
 applique; acier galvanisé, noir / verre, clair

L 170, H 260, A 100



99587 ALAMONTE

wall light; steel, black / glass, clear
 Wandleuchte; Stahl, schwarz / Glas, klar
 applique; acier, noir / verre, clair

L 170, H 295, A 100



94832 ALAMONTE 1

wall / ceiling light; zinc-plated steel, black / glass, clear
 Wand- / Deckenleuchte; Stahl verzinkt, schwarz / Glas, klar
 applique / plafonnier; acier galvanisé, noir / verre, clair

L 290, H 290, A 130



98273 ALAMONTE 1

wall light; zinc-plated steel, black / glass, clear
 Wandleuchte; Stahl verzinkt, schwarz / Glas, klar
 applique; acier galvanisé, noir / verre, clair

L 150, H 380, A 100





94788 ALAMONTE 1

pendant light; zinc-plated steel, black / glass, clear
 Hängeleuchte; Stahl verzinkt, schwarz / Glas, klar
 luminaire en suspension; acier galvanisé, noir / verre, clair

L 150, B 150, H 1285



E27 1x 60W IP44



9 002759 947880

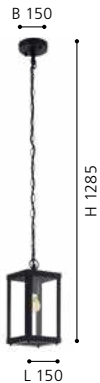



98719 MIRANDOLA

wall light; cast aluminium, black / glass, clear
Wandleuchte; Aluguss, schwarz / Glas, klar
applique; fonte d'aluminium, noir / verre, clair

L 180, H 270, A 225



97294 SONCINO

wall light; cast aluminium, black / glass, clear
Wandleuchte; Aluguss, schwarz / Glas, klar
applique; fonte d'aluminium, noir / verre, clair

L 265, H 330, A 120

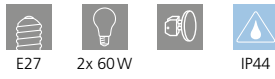

97294



98744 CIVIDINO

wall light; cast aluminium, black / satin glass, white
 Wandleuchte; Aluguss, schwarz / Glas satiniert, weiss
 applique; fonte d'aluminium, noir / verre satiné, blanc

L 120, H 260, A 115



9 002759 987442



94827 ALAMONTE

wall light; stainless steel, stainless steel / glass, clear
 Wandleuchte; Edelstahl, edelstahl / Glas, klar
 applique; acier inoxydable, acier inoxydable / verre, clair

L 170, H 260, A 100



9 002759 948276





98724 RAVELLO

floor light; zinc-plated steel, black / plastic, white
 Stehleuchte; Stahl verzinkt, schwarz / Kunststoff, weiss
 lampadaire; acier galvanisé, noir / plastique, blanc

H 1100, Ø 165, Base: Ø 115



98721 RAVELLO

wall light; zinc-plated steel, black / plastic, white
 Wandleuchte; Stahl verzinkt, schwarz / Kunststoff, weiss
 applique; acier galvanisé, noir / plastique, blanc

L 165, H 275, A 225



98722 RAVELLO

wall light; zinc-plated steel, black / plastic, white
 Wandleuchte; Stahl verzinkt, schwarz / Kunststoff, weiss
 applique; acier galvanisé, noir / plastique, blanc

L 165, H 320, A 225

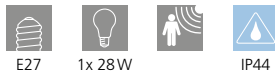

98723 RAVELLO

pedestal light; zinc-plated steel, black / plastic, white
 Sockelleuchte; Stahl verzinkt, schwarz / Kunststoff, weiss
 luminaire pour socle; acier galvanisé, noir / plastique, blanc

H 450, Ø 165, Base: Ø 115





98722



97287 SIRMIONE

floor light; zinc-plated steel, black, gold / glass opal-matt, white
 Stehleuchte; Stahl verzinkt, schwarz, gold / Glas opal-matt, weiss
 lampadaire; acier galvanisé, noir, or / verre opale mat, blanc

L 340, B 270, H 1200, Base: Ø 110

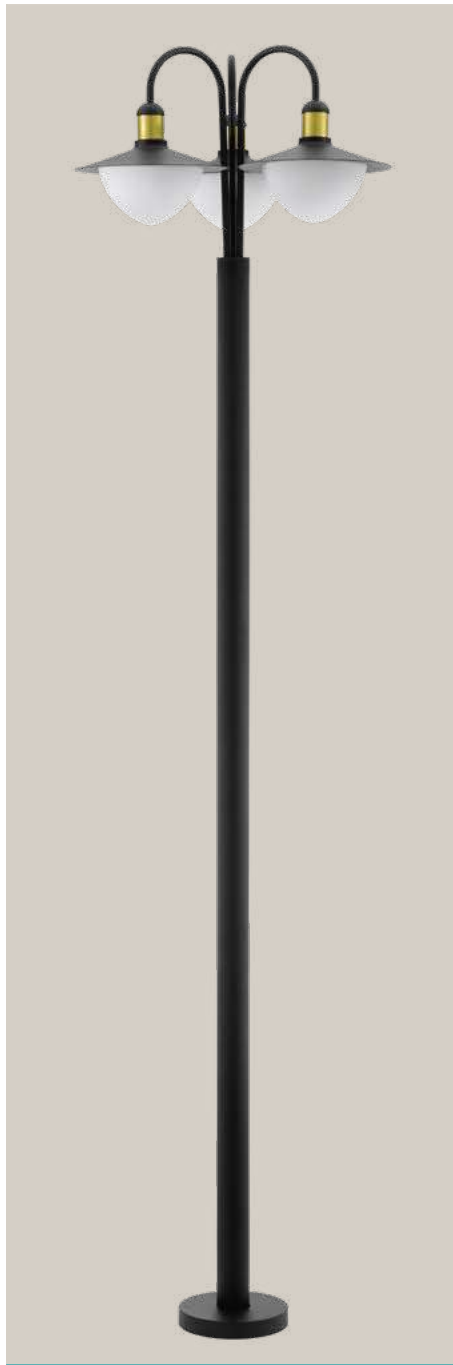

97288 SIRMIONE

floor light; zinc-plated steel, black, gold / glass opal-matt, white
 Stehleuchte; Stahl verzinkt, schwarz, gold / Glas opal-matt, weiss
 lampadaire; acier galvanisé, noir, or / verre opale mat, blanc

H 2200, Ø 550, Base: Ø 200



97285 SIRMIONE

wall light; zinc-plated steel, black, gold / glass opal-matt, white
 Wandleuchte; Stahl verzinkt, schwarz, gold / Glas opal-matt, weiss
 applique; acier galvanisé, noir, or / verre opale mat, blanc

L 270, H 375, A 330

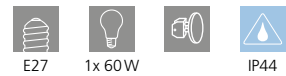

100°, 8 m
 10 sec. - 15 min.

**SAFETY &
 COMFORT**

97286 SIRMIONE

wall light; zinc-plated steel, black, gold / glass opal-matt, white
 Wandleuchte; Stahl verzinkt, schwarz, gold / Glas opal-matt, weiss
 applique; acier galvanisé, noir, or / verre opale mat, blanc

L 270, H 375, A 330

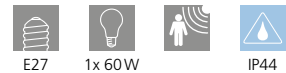



97285

97287

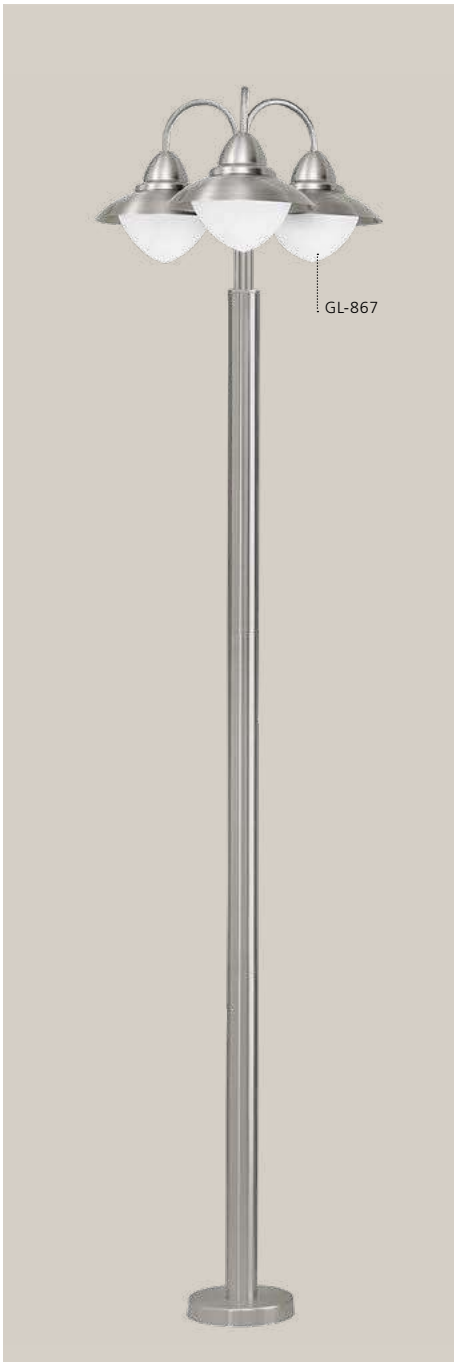

GL-867



GL-867



120°, 6 m
5 sec. - 8 min.

**SAFETY &
COMFORT**

83966 SIDNEY

wall light; stainless steel, stainless steel / glass opal-matt, white
Wandleuchte; Edelstahl, edelstahl / Glas opal-matt, weiss
applique; acier inoxydable, acier inoxydable / verre opale mat, blanc

H 375, Ø 270, A 325



E27



1x 60W



IP44



9 002759 839666



87105 SIDNEY

wall light; stainless steel, stainless steel / glass opal-matt, white
Wandleuchte; Edelstahl, edelstahl / Glas opal-matt, weiss
applique; acier inoxydable, acier inoxydable / verre opale mat, blanc

H 375, Ø 270, A 325



E27



1x 60W



IP44



9 002759 871055



83971 SIDNEY

floor light; stainless steel, stainless steel / glass opal-matt, white
Stehleuchte; Edelstahl, edelstahl / Glas opal-matt, weiss
lampadaire; acier inoxydable, acier inoxydable / verre opale mat, blanc

H 2200, Ø 600, Base: Ø 200



E27



3x 60W



IP44



9 002759 839710

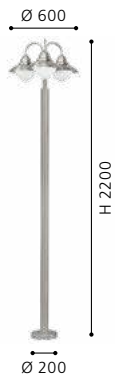

30187



30188 LISIO

floor light; stainless steel, stainless steel / glass, clear
 Stehleuchte; Edelstahl, edelstahl / Glas, klar
 lampadaire; acier inoxydable, acier inoxydable / verre, clair

H 1000, Ø 175, Base: Ø 130

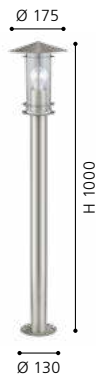
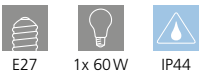

30184 LISIO

wall light; stainless steel, stainless steel / glass, clear
 Wandleuchte; Edelstahl, edelstahl / Glas, klar
 applique; acier inoxydable, acier inoxydable / verre, clair

L 175, H 300, A 225

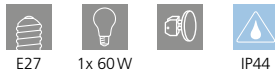

30185 LISIO

wall light; stainless steel, stainless steel / glass, clear
 Wandleuchte; Edelstahl, edelstahl / Glas, klar
 applique; acier inoxydable, acier inoxydable / verre, clair

L 175, H 360, A 225



SAFETY &
COMFORT



30187 LISIO

floor light; stainless steel, stainless steel / glass, clear
 Stehleuchte; Edelstahl, edelstahl / Glas, klar
 lampadaire; acier inoxydable, acier inoxydable / verre, clair

H 500, Ø 175, Base: Ø 130





99586 TAVERNA

wall light; zinc-plated steel, black / plastic, black-transparent
 Wandleuchte; Stahl verzinkt, schwarz / Kunststoff, schwarz-transparent
 applique; acier galvanisé, noir / plastique, noir transparent

L 200, H 230, A 255



99598 TAVERNA

wall light; zinc-plated steel, black / plastic, transparent
 Wandleuchte; Stahl verzinkt, schwarz / Kunststoff, transparent
 applique; acier galvanisé, noir / plastique, transparent

L 200, H 230, A 255



99155 SOSSANO

wall light; plastic, white / glass with air inclusions, clear
 Wandleuchte; Kunststoff, weiss / Glas mit Lufteneinschlüssen, klar
 applique; plastique, blanc / verre avec inclusions d'air, clair

L 200, H 335, A 210



SAFETY & COMFORT

180°, 6 m
 10 sec. - 15 min.



1



2

99586 & 99598

This luminaires can be mounted upwards or downwards.

Diese Leuchten können aufwärts oder abwärts montiert werden.

Ces luminaires peut être montée vers le haut ou vers le bas.



99598



94842 HILBURN

wall light; zinc-plated steel, black / plastic, transparent
Wandleuchte; Stahl verzinkt, schwarz / Kunststoff, transparent
applique; acier galvanisé, noir / plastique, transparent

L 200, H 375, A 170

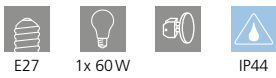

9 002759 948429

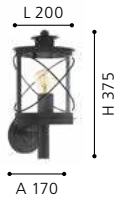

94843 HILBURN

wall light; zinc-plated steel, black / plastic, transparent
Wandleuchte; Stahl verzinkt, schwarz / Kunststoff, transparent
applique; acier galvanisé, noir / plastique, transparent

L 200, H 280, A 200

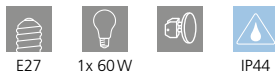

9 002759 948436



94864 HILBURN

pedestal light; zinc-plated steel, black / plastic, transparent
Sockelleuchte; Stahl verzinkt, schwarz / Kunststoff, transparent
luminaire pour socle; acier galvanisé, noir / plastique, transparent

L 200, B 135, H 410, Base: Ø 110



9 002759 948641



94865 HILBURN 1

wall light; zinc-plated steel, silver-antique / plastic, transparent
Wandleuchte; Stahl verzinkt, silber-antik / Kunststoff, transparent
applique; acier galvanisé, argent antique / plastique, transparent

L 200, H 375, A 170

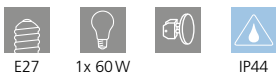

9 002759 948658

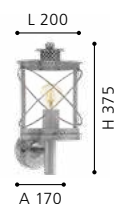

94866 HILBURN 1

wall light; zinc-plated steel, silver-antique / plastic, transparent
Wandleuchte; Stahl verzinkt, silber-antik / Kunststoff, transparent
applique; acier galvanisé, argent antique / plastique, transparent

L 200, H 280, A 200

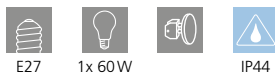

9 002759 948665

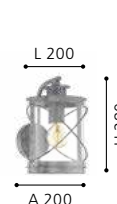



94865



GL3396

94792 MELGOA

wall light; zinc-plated steel, black / glass, clear
Wandleuchte; Stahl verzinkt, schwarz / Glas, klar
applique; acier galvanisé, noir / verre, clair

L 300, H 250, A 380



9 002759 947927



ET2397

94805 BARROSELA

wall light; zinc-plated steel, black / plastic, white
Wandleuchte; Stahl verzinkt, schwarz / Kunststoff, weiss
applique; acier galvanisé, noir / plastique, blanc

L 220, H 240, A 230



9 002759 948054



97226 CANOVE

wall light; zinc-plated steel, black / glass, clear, satiné
Wandleuchte; Stahl verzinkt, schwarz / Glas, klar, satiniert
applique; acier galvanisé, noir / verre, clair, satiné

L 230, H 240, A 235

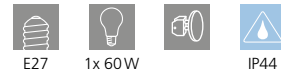

9 002759 972264

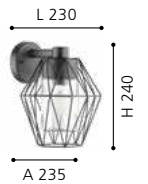

94792



ET2131

94841 PULFERO

wall light; zinc-plated steel, black / plastic, transparent
Wandleuchte; Stahl verzinkt, schwarz / Kunststoff, transparent
applique; acier galvanisé, noir / plastique, transparent

L 220, H 280, A 280

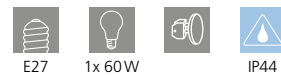

9 002759 948412





94841



94863 MELGOA

wall light; zinc-plated steel, copper-coloured antique / glass, clear
 Wandleuchte; Stahl verzinkt, kupferfarben-antik / Glas, klar
 applique; acier galvanisé, cuivré antique / verre, clair

L 300, H 250, A 380

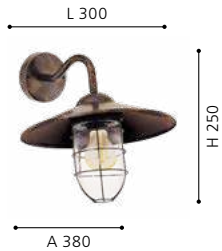

94858 BARROSELA

wall light; zinc-plated steel, copper-coloured antique / plastic, white
 Wandleuchte; Stahl verzinkt, kupferfarben-antik / Kunststoff, weiss

applique; acier galvanisé, cuivré antique / plastique, blanc

L 220, H 240, A 230

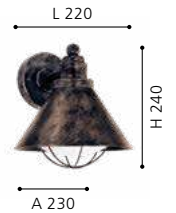

83589 MILTON

wall light; zinc-plated steel, antique-brown / glass, clear
 Wandleuchte; Stahl verzinkt, antik-braun / Glas, klar
 applique; acier galvanisé, marron antique / verre, clair

B 240, H 310, A 300

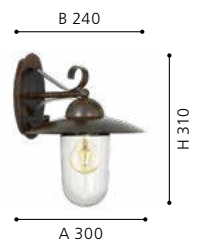
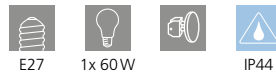



90184 SAN TELMO

wall light; zinc-plated steel, cast aluminium, antique-brown / glass with air inclusions, clear
 Wandleuchte; Stahl verzinkt, Aluguss, antik-braun / Glas mit Lufteinschlüssen, klar
 applique; acier galvanisé, fonte d'aluminium, marron antique / verre avec inclusions d'air, clair

L 180, H 350, A 240

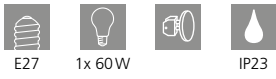

96241 VALDEO

wall light; zinc-plated steel, copper-coloured antique / glass, clear
 Wandleuchte; Stahl verzinkt, kupferfarben-antik / Glas, klar
 applique; acier galvanisé, cuivré antique / verre, clair

L 165, H 275, A 200

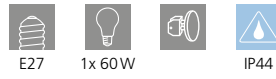

96262 ALBACETE

wall light; zinc-plated steel, brown, copper / glass with air inclusions, clear
 Wandleuchte; Stahl verzinkt, braun, kupfer / Glas mit Lufteinschlüssen, klar
 applique; acier galvanisé, marron, cuivre / verre avec inclusions d'air, clair

L 265, H 255, A 280



94855 PULFERO 1

wall light; zinc-plated steel, brown / plastic, transparent
 Wandleuchte; Stahl verzinkt, braun / Kunststoff, transparent
 applique; acier galvanisé, marron / plastique, transparent

L 220, H 280, A 280





97261 BOVOLONE

wall light; zinc-plated steel, black / glass, clear
Wandleuchte; Stahl verzinkt, schwarz / Glas, klar
applique; acier galvanisé, noir / verre, clair

L 110, H 340, A 155

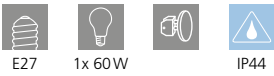

9 002759 972615



96239 VALDEO

wall light; zinc-plated steel, black / glass, clear
Wandleuchte; Stahl verzinkt, schwarz / Glas, klar
applique; acier galvanisé, noir / verre, clair

L 165, H 275, A 200

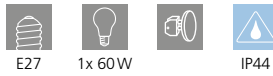

9 002759 962395



97296 TRECATE

wall light; zinc-plated steel, black / glass, clear
Wandleuchte; Stahl verzinkt, schwarz / Glas, klar
applique; acier galvanisé, noir / verre, clair

L 160, H 355, A 130

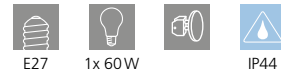

9 002759 972967



96207 ENTRIMO

wall light; zinc-plated steel, black / plastic, white
Wandleuchte; Stahl verzinkt, schwarz / Kunststoff, weiss
applique; acier galvanisé, noir / plastique, blanc

L 200, H 185, A 235

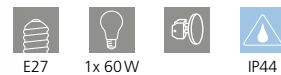

9 002759 962074





97296



98123 MONREALE

floor light; cast aluminium, black / plastic, transparent
 Stehleuchte; Aluguss, schwarz / Kunststoff, transparent
 lampadaire; fonte d'aluminium, noir / plastique, transparent

H 995, Ø 230, Base: Ø 110

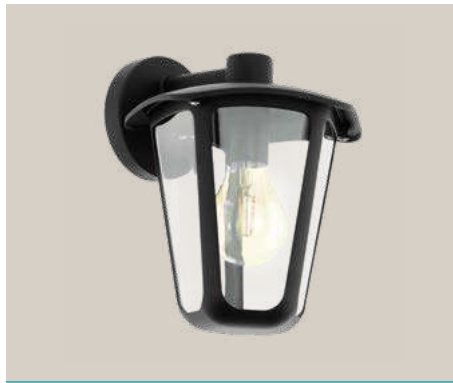
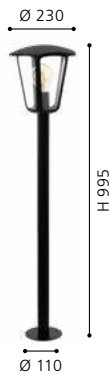

98121 MONREALE

wall light; cast aluminium, black / plastic, transparent
 Wandleuchte; Aluguss, schwarz / Kunststoff, transparent
 applique; fonte d'aluminium, noir / plastique, transparent

L 230, H 275, A 255

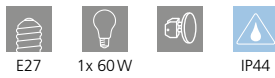

98119 MONREALE

wall light; cast aluminium, black / plastic, transparent
 Wandleuchte; Aluguss, schwarz / Kunststoff, transparent
 applique; fonte d'aluminium, noir / plastique, transparent

L 230, H 275, A 255

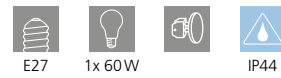

98122 MONREALE

pedestal light; cast aluminium, black / plastic, transparent
 Sockelleuchte; Aluguss, schwarz / Kunststoff, transparent
 luminaire pour socle; fonte d'aluminium, noir / plastique, transparent

H 335, Ø 230, Base: Ø 110





98121



98118 MONREALE

floor light; cast aluminium, white / plastic, transparent
 Stehleuchte; Aluguss, weiss / Kunststoff, transparent
 lampadaire; fonte d'aluminium, blanc / plastique, transparent

H 995, Ø 230, Base: Ø 110

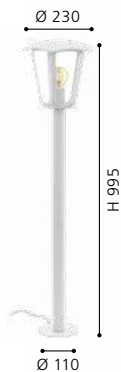

98115 MONREALE

wall light; cast aluminium, white / plastic, transparent
 Wandleuchte; Aluguss, weiss / Kunststoff, transparent
 applique; fonte d'aluminium, blanc / plastique, transparent

L 230, H 275, A 255

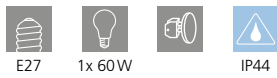

98117 MONREALE

pedestal light; cast aluminium, white / plastic, transparent
 Sockelleuchte; Aluguss, weiss / Kunststoff, transparent
 luminaire pour socle; fonte d'aluminium, blanc / plastique, transparent

H 335, Ø 230, Base: Ø 110



167

98118





93406 ALORIA

pendant light; cast aluminium, black / plastic, clear
 Hängeleuchte; Aluguss, schwarz / Kunststoff, klar
 luminaire en suspension; fonte d'aluminium, noir / plastique, clair

L 170, B 170, H 685



93409 ALORIA

floor light; cast aluminium, black / plastic, clear
 Stehleuchte; Aluguss, schwarz / Kunststoff, klar
 lampadaire; fonte d'aluminium, noir / plastique, clair

H 1800, Ø 480, Base: Ø 215



93408 ALORIA

floor light; cast aluminium, black / plastic, clear
 Stehleuchte; Aluguss, schwarz / Kunststoff, klar
 lampadaire; fonte d'aluminium, noir / plastique, clair

L 170, B 170, H 940, Base: Ø 170

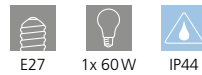



93097 ALORIA

wall light; cast aluminium, black / plastic, clear
 Wandleuchte; Aluguss, schwarz / Kunststoff, klar
 applique; fonte d'aluminium, noir / plastique, clair

L 170, H 225, A 190

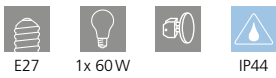

93098 ALORIA

wall light; cast aluminium, black / plastic, clear
 Wandleuchte; Aluguss, schwarz / Kunststoff, klar
 applique; fonte d'aluminium, noir / plastique, clair

L 170, H 225, A 190

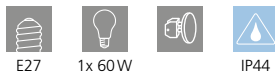

93407 ALORIA

wall light; cast aluminium, black / plastic, clear
 Wandleuchte; Aluguss, schwarz / Kunststoff, klar
 applique; fonte d'aluminium, noir / plastique, clair

L 180, H 200, A 120

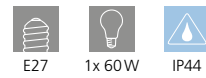

93099 ALORIA

pedestal light; cast aluminium, black / plastic, clear
 Sockelleuchte; Aluguss, schwarz / Kunststoff, klar
 luminaire pour socle; fonte d'aluminium, noir / plastique, clair

L 170, B 170, H 300, Base: Ø 170





93404 ALORIA

floor light; cast aluminium, white / plastic, clear
 Stehleuchte; Aluguss, weiss / Kunststoff, klar
 lampadaire; fonte d'aluminium, blanc / plastique, clair

L 170, B 170, H 940, Base: Ø 170

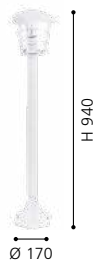

93094 ALORIA

wall light; cast aluminium, white / plastic, clear
 Wandleuchte; Aluguss, weiss / Kunststoff, klar
 applique; fonte d'aluminium, blanc / plastique, clair

L 170, H 225, A 190

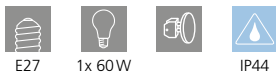

93095 ALORIA

wall light; cast aluminium, white / plastic, clear
 Wandleuchte; Aluguss, weiss / Kunststoff, klar
 applique; fonte d'aluminium, blanc / plastique, clair

L 170, H 225, A 190

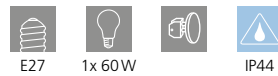

93403 ALORIA

wall light; cast aluminium, white / plastic, clear
 Wandleuchte; Aluguss, weiss / Kunststoff, klar
 applique; fonte d'aluminium, blanc / plastique, clair

L 180, H 200, A 120



93096 ALORIA

pedestal light; cast aluminium, white / plastic, clear
 Sockelleuchte; Aluguss, weiss / Kunststoff, klar
 luminaire pour socle; fonte d'aluminium, blanc / plastique, clair

L 170, B 170, H 300, Base: Ø 170





93403



93456 NAVEDO

wall light; cast aluminium, black, silver-patina / glass, clear
Wandleuchte; Aluguss, schwarz, silber-patina / Glas, klar
applique; fonte d'aluminium, noir, argent patiné / verre, clair

L 200, H 475, A 285

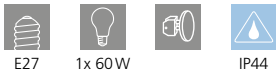

93457 NAVEDO

wall light; cast aluminium, black, silver-patina / glass, clear
Wandleuchte; Aluguss, schwarz, silber-patina / Glas, klar
applique; fonte d'aluminium, noir, argent patiné / verre, clair

L 200, H 475, A 285

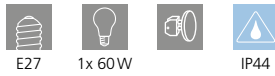

93458 NAVEDO

wall light; cast aluminium, black, silver-patina / glass, clear
Wandleuchte; Aluguss, schwarz, silber-patina / Glas, klar
applique; fonte d'aluminium, noir, argent patiné / verre, clair

L 200, H 425, A 285



93459 NAVEDO

wall light; cast aluminium, black, silver-patina / glass, clear
Wandleuchte; Aluguss, schwarz, silber-patina / Glas, klar
applique; fonte d'aluminium, noir, argent patiné / verre, clair

L 290, H 430, A 130



93462 NAVEDO

pedestal light; cast aluminium, black, silver-patina / glass, clear
Sockelleuchte; Aluguss, schwarz, silber-patina / Glas, klar
luminaire pour socle; fonte d'aluminium, noir, argent patiné / verre, clair

H 470, Ø 230, Base: Ø 170



93455 NAVEDO

pendant light; cast aluminium, black, silver-patina / glass, clear
Hängeleuchte; Aluguss, schwarz, silber-patina / Glas, klar
luminaire en suspension; fonte d'aluminium, noir, argent patiné / verre, clair

H 1045, Ø 230





93457





93465 NAVEDO

floor light; cast aluminium, black, silver-patina / glass, clear
 Stehleuchte; Aluguss, schwarz, silber-patina / Glas, klar
 lampadaire; fonte d'aluminium, noir, argent patiné / verre, clair

H 2200, Ø 560, Base: Ø 230



93464 NAVEDO

floor light; cast aluminium, black, silver-patina / glass, clear
 Stehleuchte; Aluguss, schwarz, silber-patina / Glas, klar
 lampadaire; fonte d'aluminium, noir, argent patiné / verre, clair

H 2000, Ø 230, Base: Ø 245



93463 NAVEDO

floor light; cast aluminium, black, silver-patina / glass, clear
 Stehleuchte; Aluguss, schwarz, silber-patina / Glas, klar
 lampadaire; fonte d'aluminium, noir, argent patiné / verre, clair

H 1200, Ø 230, Base: Ø 170





93454 NAVEDO

floor light; cast aluminium, white / glass, clear
 Stehleuchte; Aluguss, weiss / Glas, klar
 lampadaire; fonte d'aluminium, blanc / verre, clair

H 2200, Ø 560, Base: Ø 230



93453 NAVEDO

floor light; cast aluminium, white / glass, clear
 Stehleuchte; Aluguss, weiss / Glas, klar
 lampadaire; fonte d'aluminium, blanc / verre, clair

H 2000, Ø 230, Base: Ø 245



93452 NAVEDO

floor light; cast aluminium, white / glass, clear
 Stehleuchte; Aluguss, weiss / Glas, klar
 lampadaire; fonte d'aluminium, blanc / verre, clair

H 1200, Ø 230, Base: Ø 170





93445 NAVEDO

wall light; cast aluminium, white / glass, clear
Wandleuchte; Aluguss, weiss / Glas, klar
applique; fonte d'aluminium, blanc / verre, clair

L 200, H 475, A 285

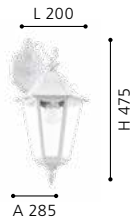
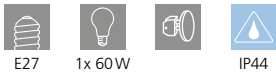

93446 NAVEDO

wall light; cast aluminium, white / glass, clear
Wandleuchte; Aluguss, weiss / Glas, klar
applique; fonte d'aluminium, blanc / verre, clair

L 200, H 475, A 285

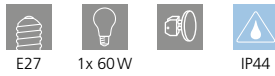

93447 NAVEDO

wall light; cast aluminium, white / glass, clear
Wandleuchte; Aluguss, weiss / Glas, klar
applique; fonte d'aluminium, blanc / verre, clair

L 200, H 425, A 285



SAFETY & COMFORT

110°, 7 m
5 sec. - 5 min.



93448 NAVEDO

wall light; cast aluminium, white / glass, clear
Wandleuchte; Aluguss, weiss / Glas, klar
applique; fonte d'aluminium, blanc / verre, clair

L 290, H 430, A 130



93451 NAVEDO

pedestal light; cast aluminium, white / glass, clear
Sockelleuchte; Aluguss, weiss / Glas, klar
luminaire pour socle; fonte d'aluminium, blanc / verre, clair

H 470, Ø 230, Base: Ø 170



97258 MANERBIO

wall light; cast aluminium, white / glass, clear
Wandleuchte; Aluguss, weiss / Glas, klar
applique; fonte d'aluminium, blanc / verre, clair

L 240, H 410, A 125



SAFETY & COMFORT

110°, 7 m
5 sec. - 5 min.



93445



22471 LATERNA 4

pendant light; cast aluminium, black / glass, clear
 Hängeleuchte; Aluguss, schwarz / Glas, klar
 luminaire en suspension; fonte d'aluminium, noir / verre, clair

H 900, Ø 205

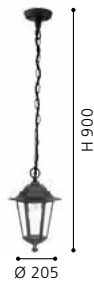

22145 LATERNA 4

floor light; cast aluminium, black / glass, clear
 Stehleuchte; Aluguss, schwarz / Glas, klar
 lampadaire; fonte d'aluminium, noir / verre, clair

H 1920, Ø 550, Base: Ø 260



22144 LATERNA 4

floor light; cast aluminium, black / glass, clear
 Stehleuchte; Aluguss, schwarz / Glas, klar
 lampadaire; fonte d'aluminium, noir / verre, clair

H 1000, Ø 205, Base: Ø 170

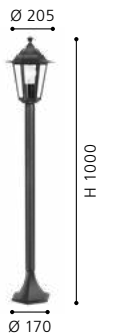



22467 LATERNA 4

wall light; cast aluminium, black / glass, clear
Wandleuchte; Aluguss, schwarz / Glas, klar
applique; fonte d'aluminium, noir / verre, clair

L 165, H 350, A 210



22468 LATERNA 4

wall light; cast aluminium, black / glass, clear
Wandleuchte; Aluguss, schwarz / Glas, klar
applique; fonte d'aluminium, noir / verre, clair

L 165, H 320, A 230

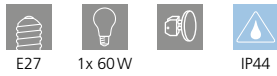

22469 LATERNA 4

wall light; cast aluminium, black / glass, clear
Wandleuchte; Aluguss, schwarz / Glas, klar
applique; fonte d'aluminium, noir / verre, clair

120°, 8 m
5 sec. - 9 min.

**SAFETY &
COMFORT**

L 165, H 360, A 215



22472 LATERNA 4

pedestal light; cast aluminium, black / glass, clear
Sockelleuchte; Aluguss, schwarz / Glas, klar
luminaire pour socle; fonte d'aluminium, noir / verre, clair

H 385, Ø 195, Base: Ø 170





22996 LATERNA 5

floor light; cast aluminium, white / glass, clear
 Stehleuchte; Aluguss, weiss / Glas, klar
 lampadaire; fonte d'aluminium, blanc / verre, clair

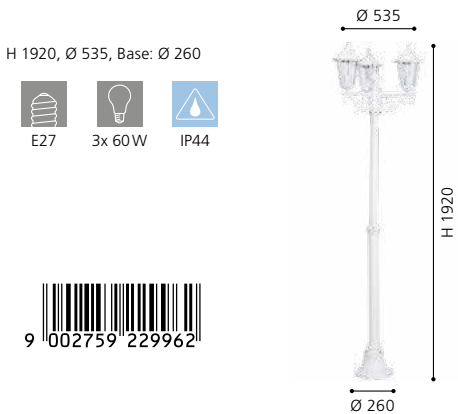

22995 LATERNA 5

floor light; cast aluminium, white / glass, clear
 Stehleuchte; Aluguss, weiss / Glas, klar
 lampadaire; fonte d'aluminium, blanc / verre, clair

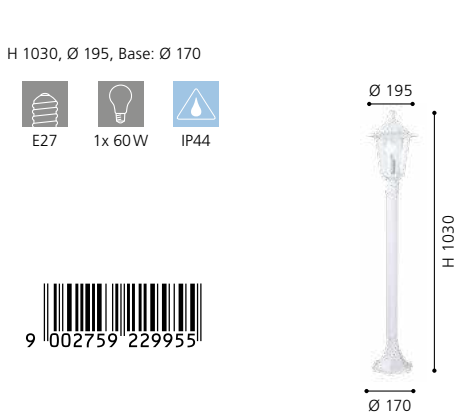

22462 LATERNA 5

wall light; cast aluminium, white / glass, clear
 Wandleuchte; Aluguss, weiss / Glas, klar
 applique; fonte d'aluminium, blanc / verre, clair

L 165, H 350, A 210

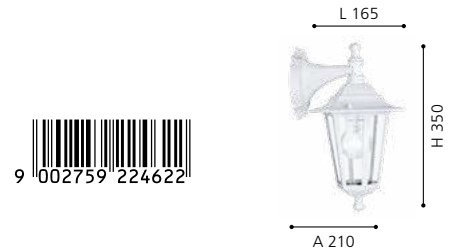
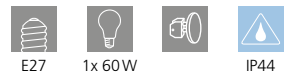

22463 LATERNA 5

wall light; cast aluminium, white / glass, clear
 Wandleuchte; Aluguss, weiss / Glas, klar
 applique; fonte d'aluminium, blanc / verre, clair

L 165, H 320, A 230

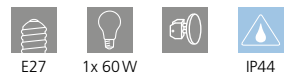



22464 LATERNA 5

wall light; cast aluminium, white / glass, clear
 Wandleuchte; Aluguss, weiss / Glas, klar
 applique; fonte d'aluminium, blanc / verre, clair

L 165, H 360, A 215



22466 LATERNA 5

pedestal light; cast aluminium, white / glass, clear
 Sockelleuchte; Aluguss, weiss / Glas, klar
 luminaire pour socle; fonte d'aluminium, blanc / verre, clair

H 385, Ø 195, Base: Ø 170



SPOTS, RECESSED & ACCESSOIRES

SPOTS, EINBAULEUCHTEN & ZUBEHÖR

SPOTS, LUMINAIRES ENCASTRÉS & ACCESSOIRES

HIGHLIGHTS FOR

OUTDOORS - Any outdoor area can be skilfully presented with spots, fitted lamps and the associated accessories. Stairwells, paths or the favourite spot in your garden will become a highlight this way.

HIGHLIGHTS FÜR DRAUSSEN - Mit Spots, Einbauleuchten und den dazugehörigen Accessoires lässt sich jeder Außenbereich gekonnt in Szene setzen. Treppenaufgänge, Wege oder der Lieblingsplatz im Garten werden so zum Highlight.



POINTS FORTS POUR



















L'EXTÉRIEUR - Des spots, les luminaires encastrables et les accessoires associés mettent en scène avec savoir tout espace extérieur. Les accès à des escaliers, les chemins ou bien votre emplacement préféré deviennent ainsi le centre des attentions.



OVERVIEW

SPOTS, RECESSED & ACCESSOIRES



							
PAGINO 168	CASABAS 168	LAMOZZO 170	LAMOZZO 1 170	PALIZZI 172	PASTION 172	LUNANO 174	LM_LED_E27 175
							
DETECT ME 5 175	DETECT ME 6 176	DETECT ME 3 176	DETECT ME 4 176	DETECT ME 1 177	NEMA 1 178	NEMA 178	FAEDO 4 178
							
SPINETOLI 179	FAEDO 3 180	FAEDO 3 184	LAMEDO 186	TRONTO 186	RIGA 3 187	ZIMBA 188	ZIMBA-LED 188
							
ARACENA 188	MARGO 190	PINEDA-IP 190	PARK 4 191	CONNECTOR BOX 191	- 192	CUBA 192	



4 x C batteries (not included)
4 x C Batterien (nicht inklusive)
4 x batterie C (non inclus)

LED

SAFETY & COMFORT

140°, 8 m
3 sec. - 7 min.

98194 CASABAS

wall light; plastic, white / plastic, satiné
Wandleuchte; Kunststoff, weiss / Kunststoff, satiniert
applique; plastique, blanc / plastique, satiné

L 190, H 240, A 120

LED **cold WHITE** **IP44**
2x 3,75W 800lm



9 002759 981945

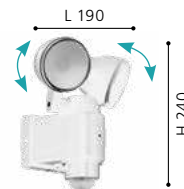

LED

SAFETY & COMFORT

150°, 12 m
5 sec. - 3 min.

98177 PAGINO

wall light; plastic, white
Wandleuchte; Kunststoff, weiss
applique; plastique, blanc

L 180, H 260, A 160

LED **neutral WHITE** **IP44**
13W 2300lm



9 002759 981778

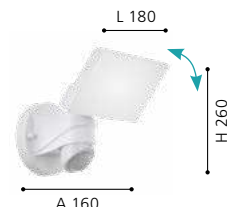

LED

SAFETY & COMFORT

150°, 12 m
5 sec. - 3 min.

98176 PAGINO

wall light; plastic, black
Wandleuchte; Kunststoff, schwarz
applique; plastique, noir

L 245, H 220, A 180

LED **neutral WHITE** **IP44**
2x 6W 1800lm



9 002759 981761



4 x C batteries (not included)
4 x C Batterien (nicht inklusive)
4 x batterie C (non inclus)

LED

SAFETY & COMFORT

140°, 8 m
3 sec. - 7 min.

98189 CASABAS

wall light; plastic, black / plastic, satiné
Wandleuchte; Kunststoff, schwarz / Kunststoff, satiniert
applique; plastique, noir / plastique, satiné

L 190, H 240, A 120

LED **cold WHITE** **IP44**
2x 3,75W 800lm



9 002759 981891



LED

SAFETY & COMFORT

150°, 12 m
5 sec. - 3 min.

98178 PAGINO

wall light; plastic, black
Wandleuchte; Kunststoff, schwarz
applique; plastique, noir

L 180, H 260, A 160

LED **neutral WHITE** **IP44**
13W 2300lm



9 002759 981785





98178



98757 LAMOZZO

wall light; plastic, white / plastic, transparent
 Wandleuchte; Kunststoff, weiss / Kunststoff, transparent
 applique; plastique, blanc / plastique, transparent

L 140, H 210, A 110



98757

Mode A: Automatically turns on at the dusk (< 30 lux) and remains 20% bright, up to 5 hours after which it turns off.
Mode B: Automatically turns on to full brightness (400 lm) when motion is detected in the range < 6 m and then turns to 3% brightness in 20 seconds of no motion.
Mode C: Automatically turns on to full brightness (400 lm) when motion is detected in the range < 6 m and then turns off in 30 seconds of no motion.

Mode A: Schaltet sich automatisch in den Dämmermodus (< 30 Lux) und bleibt bis zu 5 Stunden bei 20% der Helligkeit, bevor sie automatisch ausschaltet.
Mode B: Schaltet sich automatisch auf volle Helligkeit (400 lm), wenn eine Bewegung im Umkreis von 6 Metern erkannt wird, um nach 20 Sekunden ohne Bewegung auf 3% Helligkeit abzdimmern.
Mode C: Schaltet sich automatisch auf volle Helligkeit (400 lm), wenn eine Bewegung im Umkreis von 6 Metern erkannt wird, um nach 30 Sekunden ohne Bewegung abzuschalten.

Mode A: Allume automatiquement le crépuscule (< 30 lux) et conserve 20% de luminosité, jusqu'à 5 heures, après lesquelles il s'éteint
Mode B: Allume automatiquement en pleine luminosité (400 lm) lorsqu'un mouvement est détecté au sein d'une portée de 6 mètres, puis passe à 3% de luminosité, lors d'une absence de mouvement pendant 20 secondes.
Mode C: Allume automatiquement en pleine luminosité (400 lm) lorsqu'un mouvement est détecté au sein d'une portée de 6 mètres, puis s'éteint, lors d'une absence de mouvement pendant 30 secondes.



98758 LAMOZZO 1

wall light; plastic, black / plastic, transparent
 Wandleuchte; Kunststoff, schwarz / Kunststoff, transparent
 applique; plastique, noir / plastique, transparent

L 105, H 200, A 90

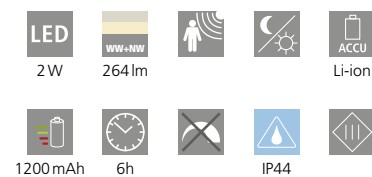



98758

	Battery above 30%		Battery below 30%	
	Front light*	Back light*	Front light	Back light
Motion detected	100 %	100 %	100 %	100 %
Motion out of range	weak	weak	off	weak

Automatically turns on to full brightness (400lm) when motion is detected in the range <6m and then turns to 3% brightness in 10 seconds if no motion is detected.

	Batterie über 30 %		Batterie unter 30 %	
	vorne	hinten	vorne	hinten
Bewegung erkannt	100 %	100 %	100 %	100 %
außerhalb Bereich	schwach	schwach	aus	schwach

Schaltet sich automatisch auf volle Helligkeit (400 lm), wenn eine Bewegung im Umkreis von 6 Metern erkannt wird, um nach 10 Sekunden ohne Bewegung auf 3% Helligkeit abzumindern.

	Batterie de plus de 30 %		Batterie moins de 30 %	
	de face	retour	de face	retour
Mouvement détecté	100 %	100 %	100 %	100 %
hors de portée	faible	faible	éteint	faible

Allume automatiquement en pleine luminosité (400 lm) lorsqu'un mouvement est détecté au sein d'une portée de 6 mètres, puis passe à 3 % de luminosité, lors d'une absence de mouvement pendant 10 secondes.



98195 CASABAS

wall light; plastic, black / plastic, white
Wandleuchte; Kunststoff, schwarz / Kunststoff, weiss
applique; plastique, noir / plastique, blanc

L 115, H 155, A 130

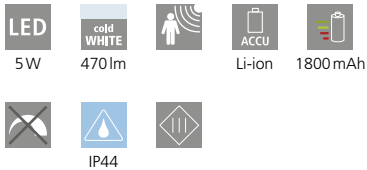

98196 CASABAS

wall light; plastic, white / plastic, white
Wandleuchte; Kunststoff, weiss / Kunststoff, weiss
applique; plastique, blanc / plastique, blanc

L 115, H 155, A 130

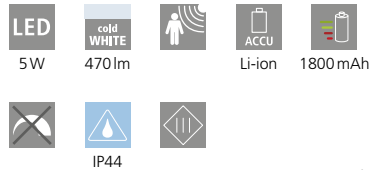

98187 PALIZZI

wall light; plastic, black / plastic, transparent
Wandleuchte; Kunststoff, schwarz / Kunststoff, transparent
applique; plastique, noir / plastique, transparent

L 155, H 145, A 110

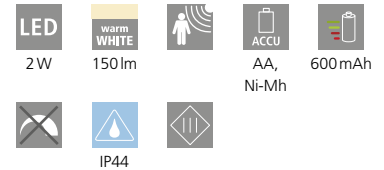

98196



98191 PASTION

wall light; plastic, black
Wandleuchte; Kunststoff, schwarz
applique; plastique, noir

L 180, H 120, A 130

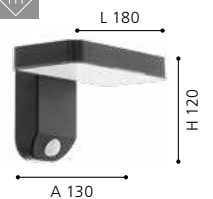
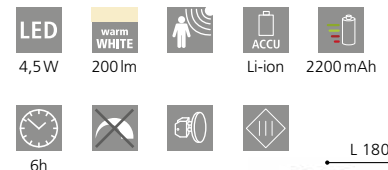



98191



97339 LUNANO

wall light; plastic, silver / plastic, white
 Wandleuchte; Kunststoff, silber / Kunststoff, weiss
 applique; plastique, argent / plastique, blanc

L 200, H 215, A 75



97339

Security and Comfort without electricity

This luminaire has a solar panel (full capacity with 6 h sun).
 No difficult cabling necessary, battery operated.

2 operation modes:

ECO mode: 3 lm / 40h bright life

Standard mode: 20lm / 8h bright life

Sicherheit und Komfort ohne Strom

Diese Leuchte hat ein Solarpanel (volle Kapazität nach 6 Sonnenstunden). Keine aufwändige Verkabelung notwendig, da batteriebetrieben.

2 Einstellungsmodi:

ECO mode: 3 lm / 40h Leuchtdauer

Standard mode: 20 lm / 8h Leuchtdauer

Sécurité et confort sans électricité

Ce luminaire dispose d'un panneau solaire (pleine capacité avec 6 h de soleil). Pas de câblage difficile nécessaire, à la batterie.

2 operation modes:

ECO mode: 3 lm / 40h vie lumineuse

Standard mode: 20lm / 8h vie lumineuse



1x

A-F

3x

0-9

97339

Letters and numbers included in delivery.

Buchstaben und Zahlen im Lieferumfang enthalten.

Les lettres et les nombres sont inclus dans la livraison.





SAFETY & COMFORT

97418 DETECT ME 5

Sensor; plastic, white
Sensor; Kunststoff, weiss
Sensor; plastique, blanc



SAFETY & COMFORT

97419 DETECT ME 5

Sensor; plastic, black
Sensor; Kunststoff, schwarz
Sensor; plastique, noir



806 lm
5 year warranty
Jahre Garantie
ans de garantie
años de garantía

SAFETY & COMFORT

11714 LM_LED_E27E27-LED-A60

Bulb; plastic, opal
Leuchtmittel; Kunststoff, opal
Ampoule; plastique, opale

L 65, H 95, A 35



IP44



9 002759 974183

L 65, H 95, A 35



IP44



9 002759 974190

L 115, Ø 60



E27

1x 9,5 W

warm WHITE

3000K

25000h

220-240V, 15000x

50/60Hz

CRI >80

10



9 002759 117146



A+



9,5 W

60 W



DAY & NIGHT
Sensor

DETECT ME 5

Automatic illumination. This photo-electric lighting controller is used for controlling lighting systems for building fronts. It automatically switches light 'ON' at dusk automatically 'OFF' again at dawn. Of course, the light-level threshold at which the sensor responds and turns the light 'ON' is defined by no other than you yourself.

Automatische Beleuchtung. Der Day & Night Sensor dient zur Steuerung von Beleuchtungsanlagen an Hausfronten und schaltet bei Dämmerung automatisch das Licht AN und am Morgen automatisch wieder AUS. Die Dämmerungsschwelle, bei der der Sensor reagiert und die Beleuchtung schaltet, definieren Sie natürlich selbst.

Un éclairage automatique. Un éclairage automatique. L'interrupteur crépusculaire pour la commande des installations d'éclairage pour les façades de maison. Il allume automatiquement la lumière au crépuscule et l'éteint automatiquement à l'aube. C'est naturellement à vous de définir le seuil de luminosité auquel doit réagir le détecteur et allumer la lumière.



DAY & NIGHT
Sensor

11714

Security and Comfort for little money

This bulb has a Day&Night sensor and switches on automatically at dusk or off at dawn. Thanks to the E27 socket the bulb can easily be exchanged for existing luminaires. With an average electricity price of € 0,16/KWh and an average lighting time of 8 hours/day, the costs amount to approx. € 5,00 per year.

Sicherheit und Komfort für wenig Geld

Dieses Leuchtmittel verfügt über einen Day&Night-Sensor und schaltet sich selbständig bei Dunkelheit ein bzw. bei Helligkeit aus. Dank der E27-Fassung kann das Leuchtmittel einfach in bestehende Leuchten getauscht werden. Bei einem durchschnittlichen Strompreis von € 0,16 / KWh und einer durchschnittlichen Leuchtdauer von 8 Stunden/Tag belaufen sich die Kosten auf ca. € 5,00 pro Jahr.

Sécurité et confort pour peu d'argent

Cette ampoule possède un capteur Day & Night et s'allume automatiquement au crépuscule ou à l'aube. Grâce à la prise E27, l'ampoule peut être facilement échangée. Avec un prix moyen de l'électricité de € 0,16 / KWh et un temps d'éclairage moyen de 8 heures / jour, les coûts s'élèvent à env. € 5,00 par an.



160°, 12 m
10 sec. - 15 min.

**SAFETY &
COMFORT**

97464 DETECT ME 3

motion detector; plastic, white
Bewegungsmelder; Kunststoff, weiss
détecteur de mouvement; plastique, blanc

L 100, H 100, A 55



IP44



9 002759 974640

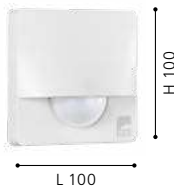

360°, 12 m
10 sec. - 15 min.

**SAFETY &
COMFORT**

97466 DETECT ME 4

motion detector; plastic, white
Bewegungsmelder; Kunststoff, weiss
détecteur de mouvement; plastique, blanc

L 70, H 55, A 100



IP44



9 002759 974664

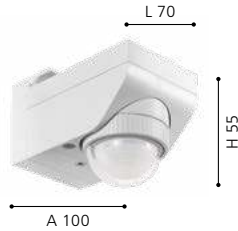

360°, 12 m
10 sec. - 15 min.

**SAFETY &
COMFORT**

97421 DETECT ME 6

motion detector; plastic, white / plastic, white
Bewegungsmelder; Kunststoff, weiss / Kunststoff, weiss
détecteur de mouvement; plastique, blanc / plastique, blanc

Ø 90, A 55



IP44



9 002759 974213



160°, 12 m
10 sec. - 15 min.

**SAFETY &
COMFORT**

97465 DETECT ME 3

motion detector; plastic, black
Bewegungsmelder; Kunststoff, schwarz
détecteur de mouvement; plastique, noir

L 100, H 100, A 55



IP44



9 002759 974657



360°, 12 m
10 sec. - 15 min.

**SAFETY &
COMFORT**

97467 DETECT ME 4

motion detector; plastic, black
Bewegungsmelder; Kunststoff, schwarz
détecteur de mouvement; plastique, noir

L 70, H 55, A 100



IP44



9 002759 974671



360°, 12 m
10 sec. - 15 min.

**SAFETY &
COMFORT**

97422 DETECT ME 6

motion detector; plastic, black / plastic, white
Bewegungsmelder; Kunststoff, schwarz / Kunststoff, weiss
détecteur de mouvement; plastique, noir / plastique, blanc

Ø 90, A 55



IP44



9 002759 974220

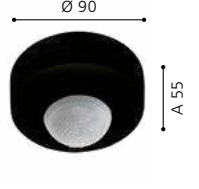



180°, 12 m
10 sec. - 15 min.

**SAFETY &
COMFORT**

96452 DETECT ME 1

motion detector; plastic, white
Bewegungsmelder; Kunststoff, weiss
détecteur de mouvement; plastique, blanc

L 55, H 70, A 80



IP44



9 002759 964528

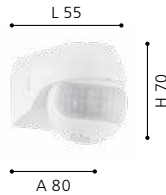

96452



DETECT ME 1

DETECT ME 3

DETECT ME 6

DETECT ME 4



MOUNT ON CEILING



MOUNT ON WALL

		•	•
•	•		•

Accessories incl. / Zubehör inkl. / Accessoires inclus



MOUNT IN CORNER



MOUNT ON CORNER

			 •
			included see page 175
10 sec. - 15 min.	10 sec. - 15 min.	10 sec. - 15 min.	10 sec. - 15 min.
12 m	12 m	12 m	12 m
180°	160°	360°	360°
+/- 40° horizontal 45° horizontal	+/- 30° horizontal +/- 90° vertical		
3 - 2000 lx	3 - 2000 lx	3 - 2000 lx	3 - 2000 lx
max. 800 W incandescent max. 400 W flourescent	max. 1200 W incandescent max. 300 W flourescent	max. 1200 W incandescent max. 300 W flourescent	max. 1200 W incandescent max. 300 W flourescent



180°, 12 m
10 sec. - 15 min.

**SAFETY &
COMFORT**

96454 DETECT ME 1

motion detector; plastic, black
Bewegungsmelder; Kunststoff, schwarz
détecteur de mouvement; plastique, noir

L 55, H 70, A 80



IP44



9 002759 964542



Ideal mounting height / Ideale Montagehöhe / Hauteur de montage ideale: ~ 2m



93384 NEMA 1

ground spike; plastic, black / plastic, transparent
 Erdspieß; Kunststoff, schwarz / Kunststoff, transparent
 piquet de terre; plastique, noir / plastique, transparent

L 115, B 60, H 185

GU10
 1x 3W
 warm WHITE
 1x 240lm
 2000
 IP44

9 002759 933845

INCL.



93385 NEMA 1

ground spike; plastic, black / plastic, transparent
 Erdspieß; Kunststoff, schwarz / Kunststoff, transparent
 piquet de terre; plastique, noir / plastique, transparent

L 115, B 115, H 180

GU10
 2x 3W
 warm WHITE
 2x 240lm
 2000
 IP44

9 002759 933852

INCL.

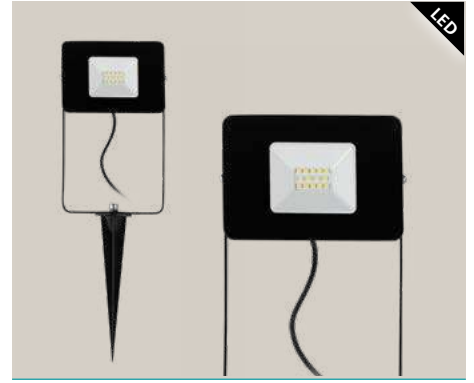

97471 FAEDO 4

ground spike; aluminium, black / glass, clear
 Erdspieß; Alu, schwarz / Glas, klar
 piquet de terre; aluminium, noir / verre, clair

L 115, B 35, H 310

LED
 neutral WHITE
 10W
 900lm
 2000
 IP65

9 002759 974718

INCL.



94111 NEMA

ground spike; stainless steel, stainless steel
 Erdspieß; Edelstahl, edelstahl
 piquet de terre; acier inoxydable, acier inoxydable

L 110, B 85, H 240, ET 165

GU10
 1x 5W
 warm WHITE
 1x 400lm
 1500
 IP54

9 002759 941116

INCL.

94111

NEMA comes with 3 different coloured bulb shades.

NEMA wird mit 3 verschiedenen farbigen Leuchtmittel-abdeckungen ausgeliefert.

NEMA vient avec 3 couvercles d'ampoule en couleurs différentes.

- GL2640 GL2642
- GL2641 GL2643



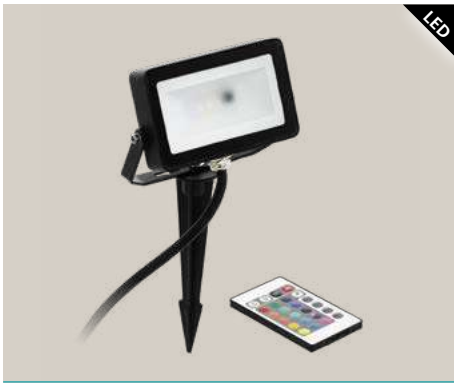

98185 FAEDO 4

flood light; aluminium, black / plastic, white
 Strahler; Alu, schwarz / Kunststoff, weiss
 projecteur; aluminium, noir / plastique, blanc

L 130, H 90, A 25

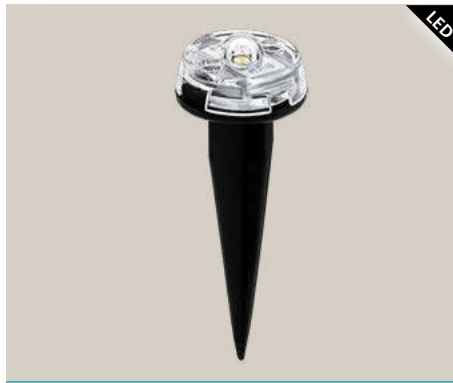

98184 SPINETOLI

ground spike; plastic, transparent / plastic, transparent
 Erdspieß; Kunststoff, transparent / Kunststoff, transparent
 piquet de terre; plastique, transparent / plastique, transparent

L 10000, B 30, H 10, ET 500

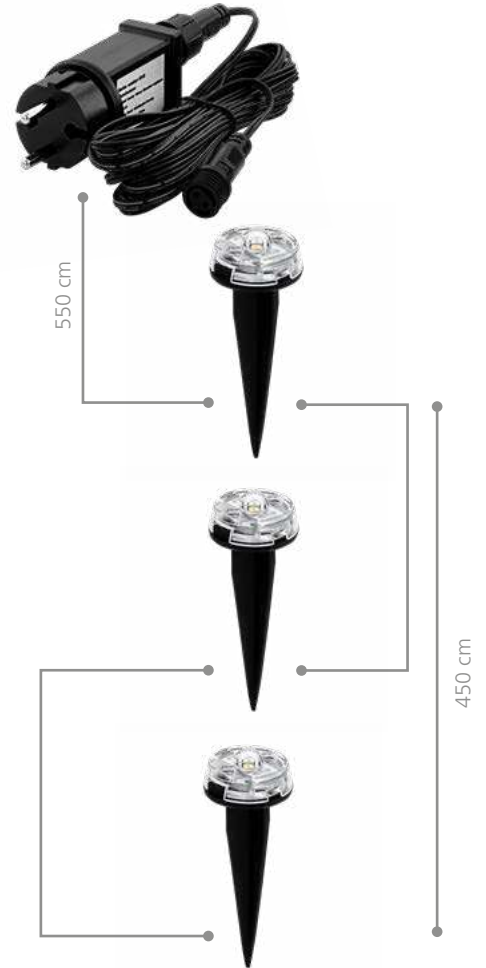



97459 FAEDO 3

wall light; aluminium, black / glass, clear
 Wandleuchte; Alu, schwarz / Glas, klar
 applique; aluminium, noir / verre, clair

L 110, H 135, A 50

LED 10W neutral WHITE 900lm



97461 FAEDO 3

wall light; aluminium, black / glass, clear
 Wandleuchte; Alu, schwarz / Glas, klar
 applique; aluminium, noir / verre, clair

L 130, H 140, A 50

LED 20W neutral WHITE 1800lm



97462 FAEDO 3

wall light; aluminium, black / glass, clear
 Wandleuchte; Alu, schwarz / Glas, klar
 applique; aluminium, noir / verre, clair

L 175, H 190, A 50

LED 30W neutral WHITE 2750lm



97463 FAEDO 3

wall light; aluminium, black / glass, clear
 Wandleuchte; Alu, schwarz / Glas, klar
 applique; aluminium, noir / verre, clair

L 205, H 200, A 50

LED 50W neutral WHITE 4800lm





97463





LED

97455 FAEDO 3

wall light; aluminium, black / glass, clear
 Wandleuchte; Alu, schwarz / Glas, klar
 applique; aluminium, noir / verre, clair

L 110, H 80, A 30



10W 900lm IP65



9 002759 974558



LED

97456 FAEDO 3

wall light; aluminium, black / glass, clear
 Wandleuchte; Alu, schwarz / Glas, klar
 applique; aluminium, noir / verre, clair

L 130, H 95, A 30



20W 1800lm IP65



9 002759 974565



LED

97457 FAEDO 3

wall light; aluminium, black / glass, clear
 Wandleuchte; Alu, schwarz / Glas, klar
 applique; aluminium, noir / verre, clair

L 175, H 135, A 30



30W 2750lm IP65



9 002759 974572



LED

97458 FAEDO 3

wall light; aluminium, black / glass, clear
 Wandleuchte; Alu, schwarz / Glas, klar
 applique; aluminium, noir / verre, clair

L 205, H 145, A 30



50W 4800lm IP65



9 002759 974589





97458



33152 FAEDO 3

wall light; aluminium, white / glass, clear
Wandleuchte; Alu, weiss / Glas, klar
applique; aluminium, blanc / verre, clair

L 110, H 80, A 30



10W 900lm IP65



33153 FAEDO 3

wall light; aluminium, white / glass, clear
Wandleuchte; Alu, weiss / Glas, klar
applique; aluminium, blanc / verre, clair

L 130, H 95, A 30



20W 1800lm IP65

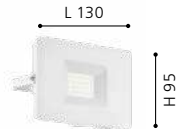

33154 FAEDO 3

wall light; aluminium, white / glass, clear
Wandleuchte; Alu, weiss / Glas, klar
applique; aluminium, blanc / verre, clair

L 175, H 135, A 30



30W 2750lm IP65

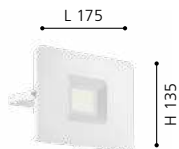

33155 FAEDO 3

wall light; aluminium, white / glass, clear
Wandleuchte; Alu, weiss / Glas, klar
applique; aluminium, blanc / verre, clair

L 205, H 145, A 30



50W 4800lm IP65

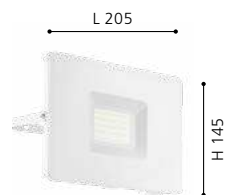



33156 FAEDO 3

wall light; aluminium, white / glass, clear
 Wandleuchte; Alu, weiss / Glas, klar
 applique; aluminium, blanc / verre, clair

L 110, H 135, A 50

LED 10W neutral WHITE 900lm

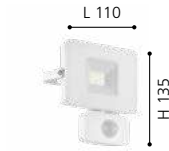

33157 FAEDO 3

wall light; aluminium, white / glass, clear
 Wandleuchte; Alu, weiss / Glas, klar
 applique; aluminium, blanc / verre, clair

L 130, H 140, A 50

LED 20W neutral WHITE 1800lm

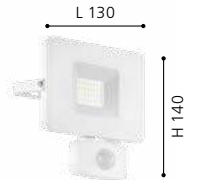

33158 FAEDO 3

wall light; aluminium, white / glass, clear
 Wandleuchte; Alu, weiss / Glas, klar
 applique; aluminium, blanc / verre, clair

L 175, H 190, A 50

LED 30W neutral WHITE 2750lm

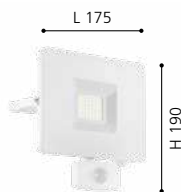

33159 FAEDO 3

wall light; aluminium, white / glass, clear
 Wandleuchte; Alu, weiss / Glas, klar
 applique; aluminium, blanc / verre, clair

L 205, H 200, A 50

LED 50W neutral WHITE 4800lm



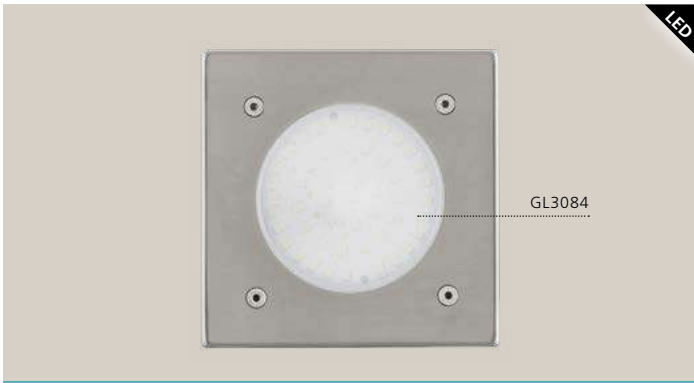

93481 LAMEDO

ground recessed light; stainless steel, stainless steel / satin glass, white
 Bodeneinbauleuchte; Edelstahl, edelstahl / Glas satiniert, weiss
 luminaire encastrable au; acier inoxydable, acier inoxydable / verre satiné, blanc

L 100, B 100, ET 65

LED
 1x 2,5W
 warm WHITE
 1x
 180lm
 IP65/67

 Ø95



9 002759 934811

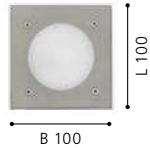

93482 LAMEDO

ground recessed light; stainless steel, stainless steel / satin glass, white
 Bodeneinbauleuchte; Edelstahl, edelstahl / Glas satiniert, weiss
 luminaire encastrable au; acier inoxydable, acier inoxydable / verre satiné, blanc

Ø 100, ET 65

LED
 1x 2,5W
 warm WHITE
 1x
 180lm
 IP65/67

 Ø90



9 002759 934828



98182 TRONTO

ground recessed light; stainless steel, plastic, stainless steel, black / plastic, transparent
 Bodeneinbauleuchte; Edelstahl, Kunststoff, edelstahl, schwarz / Kunststoff, transparent
 luminaire encastrable au; acier inoxydable, plastique, acier inoxydable, noir / plastique, transparent

H 2, Ø 45, ET 70

LED
 1W
 warm WHITE
 50lm
 IP65/67

 Ø45



9 002759 981822



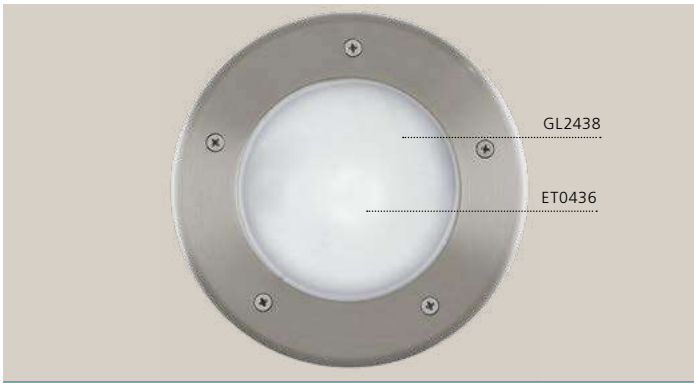

86189 RIGA 3

ground recessed light; stainless steel, stainless steel / plastic, white
 Bodeneinbauleuchte; Edelstahl, edelstahl / Kunststoff, weiss
 luminaire encastrable au; acier inoxydable, acier inoxydable / plastique, blanc

H 285, Ø 170



LAMEDO & RIGA 3 & TRONTO

No more annoying cables in your garden: bury them simply and safely with the CONNECTOR BOX.

Mit der CONNECTOR BOX können Sie störende Kabel einfach und sicher unter der Erde verschwinden lassen.

Tous les câbles incommodants disparaissent simplement et sûrement dans votre jardin avec CONNECTOR BOX.

see page 191
 siehe Seite 191
 voir page 191



86189

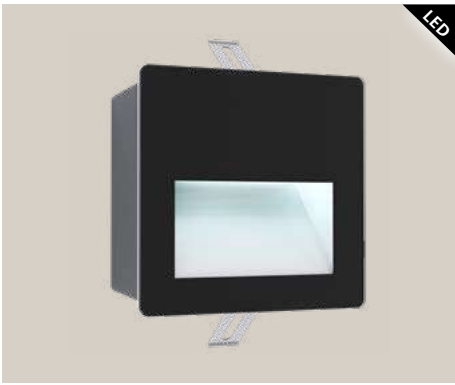

LED

99574 ARACENA

recessed light; aluminium, plastic, white, black / glass, black
 Einbauleuchte; Alu, Kunststoff, weiss, schwarz / Glas, schwarz
 luminaire encastrable; aluminium, plastique, blanc, noir / verre, noir

L 140, B 140, H 5, ET 95

LED 3,7W
 neutral WHITE 400lm

 IP65
 9 002759 995744
 RECESSED
 L 140 B 140



LED

99575 ARACENA

recessed light; aluminium, plastic, white, black / glass, white
 Einbauleuchte; Alu, Kunststoff, weiss, schwarz / Glas, weiss
 luminaire encastrable; aluminium, plastique, blanc, noir / verre, blanc

L 140, B 140, H 5, ET 95

LED 3,7W
 neutral WHITE 400lm

 IP65
 9 002759 995751
 RECESSED
 L 140 B 140



LED

99523 ZIMBA-LED

recessed light; cast aluminium, silver
 Einbauleuchte; Aluguss, silber
 luminaire encastrable; fonte d'aluminium, argent

L 140, B 140, H 5, ET 95

LED 3,7W
 neutral WHITE 400lm

 IP65
 9 002759 952358
 RECESSED
 L 140 B 140

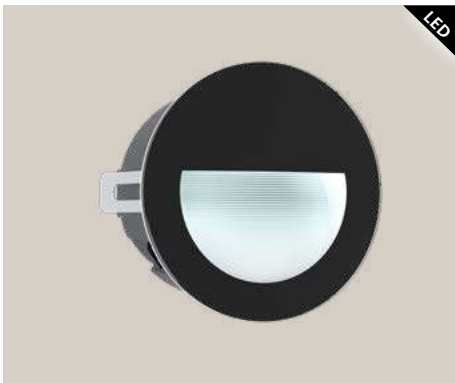

LED

99576 ARACENA

recessed light; aluminium, plastic, white, black / glass, black
 Einbauleuchte; Alu, Kunststoff, weiss, schwarz / Glas, schwarz
 luminaire encastrable; aluminium, plastique, blanc, noir / verre, noir

H 5, Ø 125, ET 95

LED 2,5W
 neutral WHITE 320lm

 IP65
 9 002759 995768
 RECESSED
 Ø 125

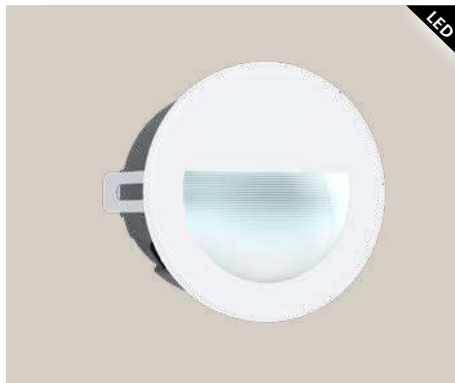

LED

99577 ARACENA

recessed light; aluminium, plastic, white, black / glass, white
 Einbauleuchte; Alu, Kunststoff, weiss, schwarz / Glas, weiss
 luminaire encastrable; aluminium, plastique, blanc, noir / verre, blanc

H 5, Ø 125, ET 95

LED 2,5W
 neutral WHITE 320lm

 IP65
 9 002759 995775
 RECESSED
 Ø 125



ARACENA

These spots come with a installation box.

Bei diesen Leuchten ist eine Einbaudose im Lieferumfang enthalten.

Avec ces lumières, il y a une boîte d'installation inclus.



88575 ZIMBA

recessed light; cast aluminium, silver / satin glass, white
 Einbauleuchte; Aluguss, silber / Glas satiniert, weiss
 luminaire encastrable; fonte d'aluminium, argent / verre satiné, blanc

L 227, B 127, H 13, ET 75

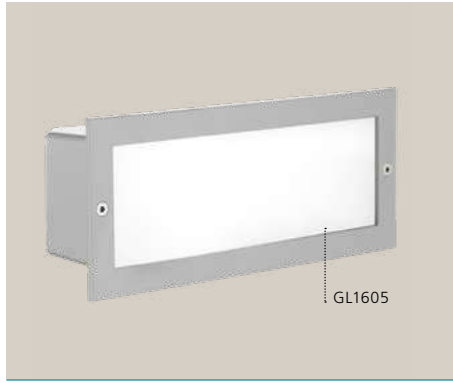
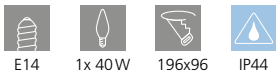

88008 ZIMBA

recessed light; cast aluminium, silver / satin glass, white
 Einbauleuchte; Aluguss, silber / Glas satiniert, weiss
 luminaire encastrable; fonte d'aluminium, argent / verre satiné, blanc

L 243, B 101, H 5, ET 100

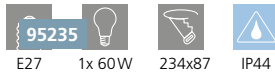

95233 ZIMBA-LED

recessed light; cast aluminium, silver
 Einbauleuchte; Aluguss, silber
 luminaire encastrable; fonte d'aluminium, argent

H 5, Ø 125, ET 95



99574



94093 MARGO

recessed light; cast aluminium, white / satin glass, white

Einbauleuchte; Aluguss, weiss / Glas satiniert, weiss

luminaire encastrable; fonte d'aluminium, blanc / verre satiné, blanc

H 10, Ø 84, ET 125



Ø 84



94092 MARGO

recessed light; cast aluminium, stainless steel / satin glass, white

Einbauleuchte; Aluguss, edelstahl / Glas satiniert, weiss

luminaire encastrable; fonte d'aluminium, acier inoxydable / verre satiné, blanc

H 10, Ø 84, ET 125



Ø 84



96415 PINEDA-IP

recessed light; plastic, satin nickel

Einbauleuchte; Kunststoff, nickel-matt

luminaire encastrable; plastique, nickel mat

Ø 78, ET 35



IP44/20



Ø 78



IP65 / IP44

PINEDA-IP & MARGO

These luminaires are protected with IP65 / IP44 on the frontside and IP20 on the backside.

Diese Leuchten sind mit IP65 / IP44 frontseitig und IP20 rückseitig geschützt.

Disposent d'un degré de protection élevé IP65 / IP44 en face avant et IP20 en face arrière pour l'utilisation.



90748 PARK 4

accessory; stainless steel, stainless steel / plastic, green
 Zubehör; Edelstahl, edelstahl / Kunststoff, grün
 accessoire; acier inoxydable, acier inoxydable / plastique, vert

L 110, B 110, H 400, Base: B 155, T 155



IP44



9 002759 907488



93426 PARK 4

accessory; steel, plastic, black
 Zubehör; Stahl, Kunststoff, schwarz
 accessoire; acier, plastique, noir

L 110, B 110, H 400, Base: B 155, T 155



IP44



9 002759 934262



CONNECTOR BOX

No more annoying cables in your garden: bury them simply and safely with the CONNECTOR BOX.

91206: 1 supply line and 2 distribution lines

91207: 1 supply line and 5 distribution lines

Mit der CONNECTOR BOX können Sie störende Kabel einfach und sicher unter der Erde verschwinden lassen.

91206: 1 Zuleitung und 2 Verteilungsleitungen

91207: 1 Zuleitung und 5 Verteilungsleitungen

Tous les câbles inconfortables disparaissent simplement et sûrement dans votre jardin avec CONNECTOR BOX.

91206: 1 alimentation et 2 lignes de distribution

91207: 1 alimentation et 5 lignes de distribution



91206 CONNECTOR BOX

accessory; plastic, black
 Zubehör; Kunststoff, schwarz
 accessoire; plastique, noir

H 50, Ø 155



IP68



9 002759 912062



Ø 155



91207 CONNECTOR BOX

accessory; plastic, black
 Zubehör; Kunststoff, schwarz
 accessoire; plastique, noir

H 50, Ø 155



IP68



9 002759 912079



Ø 155



88152

accessory; steel, white
Zubehör; Stahl, weiss
accessoire; acier, blanc

H 50, Ø 112



88153

accessory; steel, black
Zubehör; Stahl, schwarz
accessoire; acier, noir

H 50, Ø 112



88744 CUBA

ground spike; steel, zinc-plated
Erdspieß; Stahl, feuerverzinkt
piquet de terre; acier, galvanisé à chaud

H 300, Ø 185



8



9 002759 881528



Ø 112



9 002759 881535



Ø 112



9 002759 887445

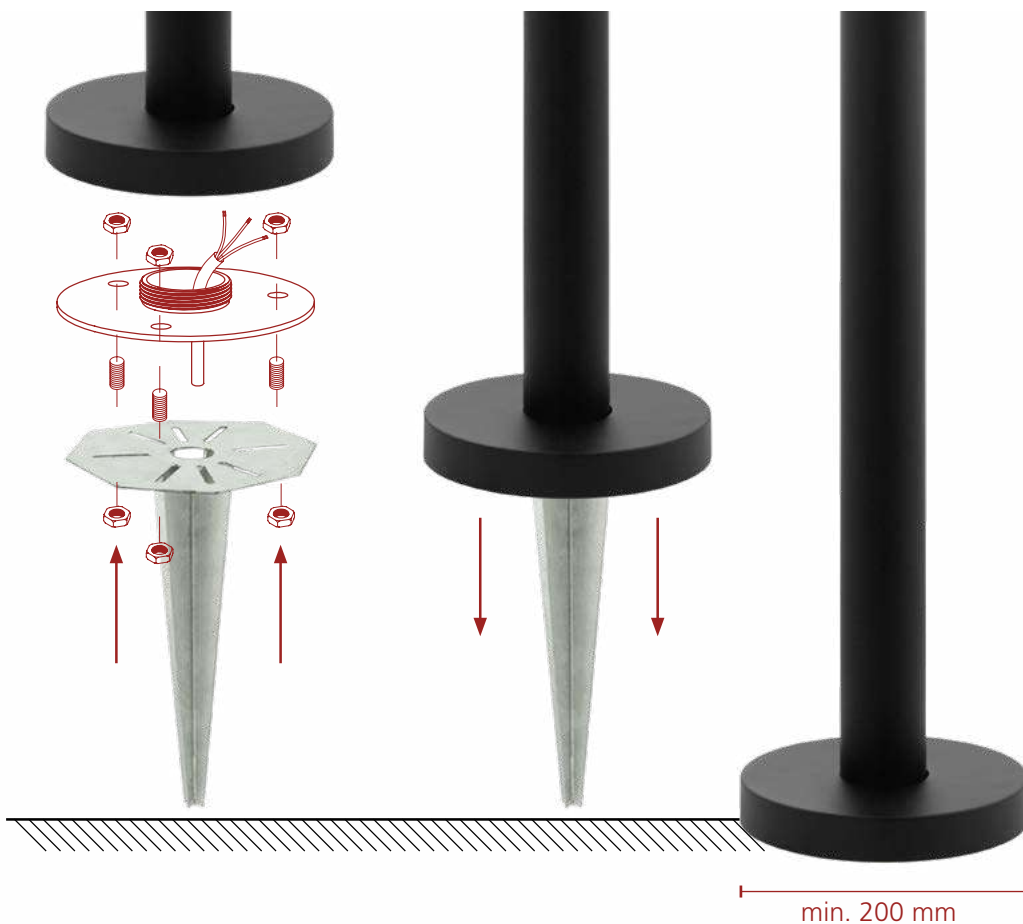
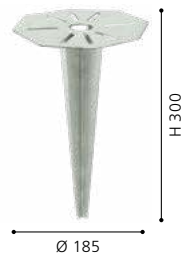

88744

With the CUBA ground spike you can stick your floor luminaire in the ground or set it in concrete.

Mit dem CUBA Erdspieß können Sie Ihre Stehleuchte in den Boden stecken oder einbetonieren.

Avec le piquet de terre CUBA vous pouvez fixer votre lampadaire en sol ou au béton.

min. 200 mm



88152, 88153

The above mentioned pictogram indicates suitable luminaires which can be easily mounted on corners with this accessories.

Das oben gezeigte Piktogramm markiert passende Leuchten, welche mit dem Zubehör einfach an Ecken montiert werden können.

Le pictogramme ci-dessus marque les luminaires correspondant, qui peut être monté avec les accessoires simples dans les coins.

88152

GARDEN LIVING



OVERVIEW

GARDEN LIVING



MONTEROLO
196



MONTEROLO
196



MONTEROLO
196



MONTEROLO
196



98101 MONTEROLO

floor light; plastic, white / plastic, white
Stehleuchte; Kunststoff, weiss / Kunststoff, weiss
lampadaire; plastique, blanc / plastique, blanc

H 300, Ø 300, Base: Ø 120

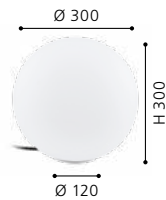
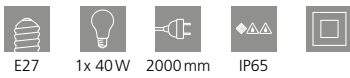

98102 MONTEROLO

floor light; plastic, white / plastic, white
Stehleuchte; Kunststoff, weiss / Kunststoff, weiss
lampadaire; plastique, blanc / plastique, blanc

H 390, Ø 390, Base: Ø 195

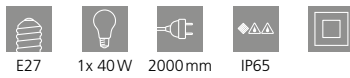

98103 MONTEROLO

floor light; plastic, white / plastic, white
Stehleuchte; Kunststoff, weiss / Kunststoff, weiss
lampadaire; plastique, blanc / plastique, blanc

H 500, Ø 500, Base: Ø 195

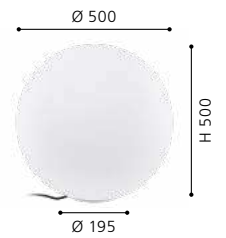

98104 MONTEROLO

floor light; plastic, white / plastic, white
Stehleuchte; Kunststoff, weiss / Kunststoff, weiss
lampadaire; plastique, blanc / plastique, blanc

H 600, Ø 600, Base: Ø 195

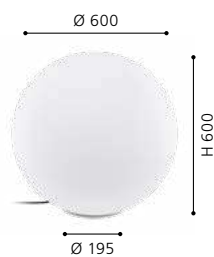



98102

98103

ENERGY EFFICIENCY LABELS

ENERGIEEFFIZIENZ-LABEL

LABEL DE L'EFFICACITÉ ÉNERGÉTIQUE

LED LUMINAIRES - are increasingly popular and the demand for energy-efficient solutions is gaining strength. This has resulted in the adoption of several EU regulations prescribing the energy efficiency labelling of light sources and luminaires. We have prepared a brief overview of the new energy labels.

LED LEUCHTMITTEL - sind am Vormarsch, der Ruf nach energieeffizienten Lösungen wird immer größer. In den letzten Jahren wurden daher mehrere EU-Verordnungen verabschiedet, die die Kennzeichnung der Energieeffizienz bei Leuchtmitteln und Leuchten vorschreibt. Hier finden Sie eine kurze Übersicht der neuen Energieeffizienzkenzeichnung.



LES ÉCLAIRAGES LED - gagnent du terrain, la demande de solutions efficaces en énergie ne cesse de croître. C'est la raison pour laquelle plusieurs directives européennes prescrivant le marquage de l'efficacité énergétique des moyens d'éclairage et des lampes ont été promulguées au cours de ces dernières années. Vous trouverez ici un bref aperçu d'ensemble des nouveaux marquages de l'efficacité énergétique.

EEL BUTTONS

bulbs included

inkl. Leuchtmittel | ampoules comprises



incl. highly efficient LED boards
(cannot be replaced by the end consumer)

inkl. hocheffizienter LED Platinen
(können nicht vom Endkonsumenten
ausgetauscht werden)

incl. platines LED très efficaces (ne
peuvent pas être remplacés par le
consommateur final)



incl. highly efficient LED bulbs

inkl. hocheffizienter LED Leuchtmittel
ampoules à LED plus efficaces comprises



incl. efficient LED and/or fluorescent bulbs

inkl. effizienter LED und/oder
Leuchtstoff-Leuchtmittel

ampoules à LED et/ou fluorescentes
efficaces comprises



incl. halogen bulbs

inkl. Halogen-Leuchtmittel
ampoules halogènes comprises

bulbs not included

exkl. Leuchtmittel | ampoules non comprises



The luminaire is compatible with bulbs of
all energy classes.

Die Leuchte ist mit Leuchtmitteln aller
Energieklassen kompatibel.

compatible avec des ampoules de toutes
les classes de l'énergie



The luminaire is only compatible with
energy efficient bulbs.

Die Leuchte ist nur mit energieeffizienten
Leuchtmitteln kompatibel.

compatible uniquement avec des ampoules
économiques en énergie

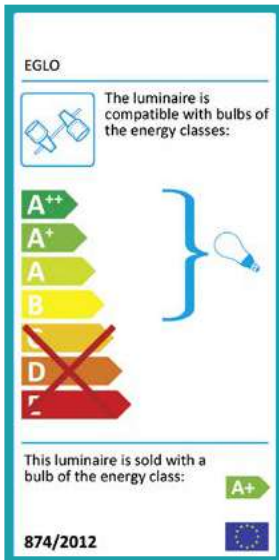

The information in brackets at the centre of the label indicates which bulbs may be used for the luminaire. In this case, the product is only compatible with bulbs with an energy efficiency rating of better than C.

Die Klammer in der Mitte des Labels gibt an, mit welchen Leuchtmitteln die Leuchte kompatibel ist. In diesem Fall dürfen nur Leuchtmittel verwendet werden, deren Energieklasse effizienter als C ist.

La parenthèse au milieu du label indique les moyens d'éclairage avec lesquels la lampe est compatible. Il est seulement permis dans ce cas d'utiliser des moyens d'éclairage dont la classe d'énergie présente une efficacité supérieure à C.

If bulbs are included with the luminaire, their energy classes are indicated at the bottom of the label.

Falls Leuchtmittel inkludiert sind, wird deren Energieklasse im unteren Teil des Labels angegeben.

Si des moyens d'éclairage sont inclus, leur classe énergétique est indiquée dans la partie inférieure du label.

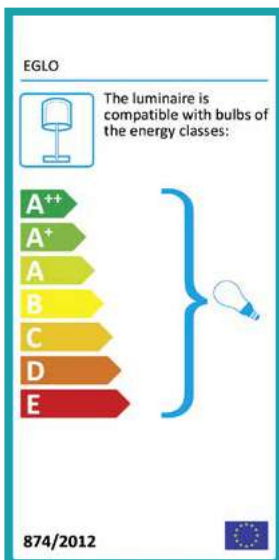

This label indicates that no bulbs are included with the luminaire. Consumers are free to choose their preferred bulb within the indicated energy classes.

Dieses Label wird verwendet, wenn die Leuchte ohne Leuchtmittel ausgeliefert wird. Der Kunde kann selber entscheiden, welches Leuchtmittel der angegebenen Klassen verwendet wird.

Ce label est utilisé lorsque la lampe est livrée sans ampoules. Le client peut décider lui-même quel ampoule des classes indiquées est utilisé.

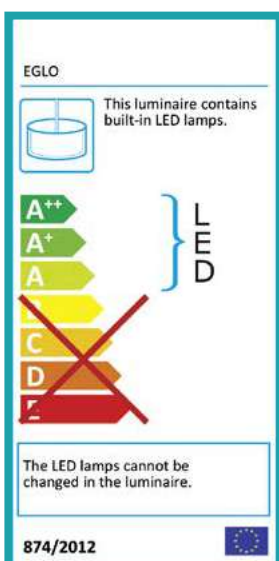

This label indicates that the luminaire is sold with built-in LED lamps that cannot be replaced by the consumer himself.

Dieses Label wird verwendet, wenn Leuchten mit LED-Modulen verkauft werden, die vom Endkunden nicht selbstständig ausgetauscht werden können.

Ce label est utilisé lorsque des lampes sont vendues avec des modules LED ne pouvant pas être changés par les clients finaux eux-mêmes.

EGLO WORLDWIDE

EGLO WELTWEIT
EGLO DANS LE MONDE



 **HEADQUARTERS**
EGLO LEUCHTEN GMBH
Heiligkreuz 22
A-6136 PILL
T: +43 5242 6996 0 | F: +43 5242 6996 972
E: info-austria@eglo.com

 **CANADA**
EGLO CANADA INC.
20700 Route Transcanadienne
Baie-D'Urfé, Québec | H9X 4B7
T: +1 514 457 5483 | F: +1 514 457 5487
E: info-canada@eglo.com

 **CZECH REPUBLIC**
EGLO CZ+SK s.r.o.
Náchodská 2479/63
CZ-193 00 PRAHA 9 Horní Počernice
T: +420 281 924 163 | F: +420 281 925 205
E: info-czechrepublic@eglo.com

 **AUSTRALIA**
EGLO LIGHTING AUSTRALIA
5/339 Archerfield Road
Richlands | Queensland 4077
T: +61 7 3375 1413 | F: +61 7 3375 1412
E: info-australia@eglo.com

 **CHILE - SANTIAGO**
EGLO CHILE ILUMINACION LTDA.
Av. Américo Vespucio 1930
Conchali - SANTIAGO DE CHILE
T: +562 2 595 2222
E: info-chile@eglo.com

 **DENMARK**
EGLO DANMARK A/S
Agerbakken 20
DK-8362 Høring
T: +45 70 22 55 11 | F: +45 70 22 55 21
E: info-denmark@eglo.com

 **BELGIUM**
EGLO BELGIUM B.V.B.A.
Antwerpsesteenweg 247 | B-2950 Kapellen
Visit Address: Innovatiepark 20 |
4906 AA OOSTERHOUT (NL)
T: +32 3 250 60 80 | F: +32 3 219 80 67
E: info-belgium@eglo.com

 **CHINA**
DONGGUAN EGLO CHINA LIGHTING CO., LTD.
No.1 | Shangqiao Industrial Road | Shangqiao,
Dongcheng District
DONGGUAN CITY, GUANZHOU PROVINCE | CHINA
T: +86 769 2203 3866 | F: +86 769 2203 6866
E: info-china@eglo.com

 **ESTONIA**
MOODNE VALGUSTUS AS
Rävala pst. 7
EE-10143 TALLINN
T: +372 667 6670 | F: +372 631 3195
E: info-global@eglo.com

 **BOSNIA-HERZEGOVINA**
EGLO RASVJETA BH D.O.O.
Ormanica bb
BIH-76250 GRADACAC
T: +387 35 86 85 00 | F: +387 35 82 44 41
E: Info-Bosnia-Herzegovina@eglo.com

 **COLOMBIA**
EGLO Colombia
AUTOPISTA NORTE KM 19 LOTE 30 COSTADO ORIEN
TAL CHÍA / COLOMBIA / BOGOTÁ - CHIA
T: +57 1 744 23 39
E: contacto@eglo.com.co

 **FINLAND**
EGLO FINLAND OY
Malminraitti 17A
00700 Helsinki
T: +358 20 7649 820 | F: +358 20 7649 821
E: info-finland@eglo.com

 **BRAZIL**
EGLO DO BRASIL LUMINÁRIAS LTDA.
Villa Lobos Office Park | Av. Queiroz Filho, 1.700,
Torre D, Sala 1, Vila Hamburguesa - São Paulo - Brasil
CEP: 05319-000, T: +55 11 4193 6980
F: +55 11 2337-3921 | E: Info-Brazil@eglo.com

 **COSTA RICA**
EGLO Costa Rica, Centro Comercial Calle Real local #8
Guachipilín de Escazú de la sucursal del BAC
San Jose 800 metros al norte San Jose Costa Rica.
T: +506-2289-4690, +506-2100-6384
E: Info-CostaRica@eglo.com

 **FRANCE**
EGLO FRANCE LUMINAIRE SARL
Z.A. Jeune Bois | 2 Rue de la Martinique
F-68274 WITTENHEIM
T: +33 389 6250 30 | F: +33 389 6250 49
E: info-france@eglo.com

 **BULGARIA**
EGLO BULGARIA EOOD
Main Road Burgas-Sofia, 5th kilometer,
Building KACHIKA, 8000 BOURGAS, Bulgaria
T: +359 56 960 403 | F: +359 56 53 05 95
E: info-bulgaria@eglo.com

 **CROATIA**
EGLO RASVJETA D.O.O.
Josipa Loncara 3
HR-10000 ZAGREB
T: +385 1 379 40 62 | F: +385 1 379 41 04
E: info-croatia@eglo.com

 **GERMANY**
EGLO LEUCHTEN HANDELS GMBH
Kleinbahnstr. 35
D-59759 ARNSBERG
T: +49 2932 6269 0 | F: +49 2932 6269 39
E: info-germany@eglo.com



GREECE
EGLO HELLAS A.E.
Sykias 2 and parodos dekeleias
ACHARNAI, GR-13679
T: +30 210 240 77 10 | F: +30 210 240 07 29
E: info-greece@eglo.com



GREAT BRITAIN
EGLO UK LTD.
Unit 12 Cirrus Park, Lower Farm Road, Moulton Park
Industrial Estate, NORTHAMPTON NN3 6UR
T: +44 1604 790 986 | F: +44 1604 670 282
E: info-greatbritain@eglo.com



HUNGARY - PRODUCTION & LOGISTICS
EGLO MAGYARORSZAG KFT.
Fő út. 155
H-3060 PASZTO
T: + 36 32 560 050 | F: +36 32 560 040
E: info-hungary@eglo.com



INDIA
EGLO INDIA PRIVATE LIMITED
A-307 Ansal Chamber-1, 3 Bhikaji Cama Place,
New Delhi-110066
T: +91 981 108 2205 | F: +91 999 961 0450
E: info-india@eglo.com



ITALY
EGLO ITALIANA S.R.L.
Via Giotto, 4
I-31021 MOGLIANO VENETO (TV)
T: +39 041 45 66 232/245/251 | F: +39 041 45 74 066/071
E: info-italy@eglo.com



KAZAKHSTAN
EGLO KAZAKHSTAN LLP
Office 72, 14th floor, Block 4A, Nurlı-Tau Business Centr,
Al-Farabi Avenue 7, 050059 Almaty, Kazakhstan
T: +7 727 293 25 20 | M: +7 701 031 00 00
E: info-kazakhstan@eglo.com



KOSOVO
EGLO KOSOVO LLC
Lugisht e qytetit pn
20000 PRIZREN- KOSOVO
T: +377 44 2166 87 | Shop: +381 29 2442 84
E: info-kosovo@eglo.com



LITHUANIA
MOODNE VALGUSTUS AS
Rāvala pst. 7
EE-10143 TALLINN
T: +370 652 49923 | T: +372 667 6670
E: info-lithuania@eglo.com



MAGYARORSZÁG – ÉRTÉKESÍTÉS
EGLO LUX KFT.
Fő út. 143/A
H-2120 DUNAKESZI
T: +36 27 341 353 | F: +36 27 341 409
E: info-hungary@eglo.com



MALAYSIA
EGLO ASIA SDN BHD
No. 13, Jalan Pelukis U1/46B, Temasya 18, Glenmarie,
40150 Shah Alam, Selangor Darul Ehsan, Malaysia
T: +6011 1050 2336 | F: +603 5567 9415
E: info-malaysia@eglo.com



MEXICO
EGLO MÉXICO ILUMINACIÓN S DE RL DE CV
Prolongación Avenida López Mateos Sur N°3561,
Fraccionamiento Los Gavilanes.
C.P. 45645, Tlajomulco de Zúñiga, Jalisco, México
T: +52 33 3687 20 95 | E: info-mexico@eglo.com



MIDDLE EAST
EGLO LIGHTING MIDDLE EAST FZE
P.O. BOX 262073, LOB 6, OFFICE G18
JEBEL ALI, DUBAI, UAE
T: +97 148810080 | F: +97 148810081
E: info.me@eglo.com



MOROCCO
EGLO AFRICA
219 Bd Med Zerktouni. Suite: 67
20330 CASABLANCA | Morocco
T: +212 522 98 80 25 / 05
E: info-global@eglo.com / info.africa@eglo.com



THE NETHERLANDS
EGLO VERLICHTING NEDERLAND B.V.
Innovatiepark 20
4906 AA OOSTERHOUT (NBR)
T: +31 162 48 28 30
E: info-nl@eglo.com



NORWAY
ELEKTRO-ARMATUR a.s
Bjørnerudveien 18
N-1266 OSLO
T: +47 2262 9000 | F: +47 2262 9040
E: info-norway@eglo.com



PERU
EGLO PERU S.A.C
Avda. Santa Cruz No. 458 Distrito de San Isidro
Provincia y Departamento Lima, San Isidro - Lima
T: +51 1 4212 158
E: info-peru@eglo.com



PHILIPPINES
PHILIP Lighting Pilipinas Corp.
4/F One E-Com Center Building, Ocean Drive, Mall
of Asia Complex, Pasay City 1300 Philippines
T: +63 2 737 9419
E: info-global@eglo.com



POLAND
EGLO POLSKA SP. Z.O.O.
Ul. Pulawska 479
02-844 WARSZAWA
T: +48 22 644 57 55 | F: +48 22 644 89 82
E: info-poland@eglo.com



PORTUGAL
EGLO PORTUGAL ILUMINAÇÃO, LDA
Rua Fonte Parada, 125
PT-4595-434 SEROA-PAÇOS DE FERREIRA
T: +351 255 890 000 | F: +351 255 892 346
E: info-portugal@eglo.com



ROMANIA
EGLO ROMANIA PRODEXIM SRL.
Str. Atomistilor nr. 1D
R-077125 MAGURELE - ILFOV - ROMANIA
T: +40 314 250 902 | F: +40 314 250 899
E: info-romania@eglo.com



RUSSIA
EGLO LIGHTING LLC
Varshavskoe shosse 35 | Building 1
RU-117105 | MOSCOW
T: +7495 789 4311 | F: +7495 789 4312
E: info-russia@eglo.com



SERBIA
EGLO RASVETA DOO
Stefana Prvovenčanog 28
11000 BEOGRAD | SRBIJA
T: +381 11 3981 366 | F: +381 11 3981 389
E: info-serbia@eglo.com



SLOVAKIA
EGLO CZ+SK s.r.o
Náhodská 2479/63
CZ-193 00 PRAHA 9 Horní Počernice
T: +421 313 211 551 | F: +421 313 211 556
E: info-slovakia@eglo.com



SLOVENIA
EGLO RASVJETA D.O.O.
Josipa Loncara 3
HR-10000 ZAGREB
T: +386 158 093 18
E: info-slovenia@eglo.com



SPAIN
EGLO ESPANA ILUMINACION S.L.
Avda. de Castilla 1 (Edf. Best Point) 2º-16A
San Fernando de Henares, E-28830 MADRID
T: +34 91 677 9044 | F: +34 91 677 0304
E: info-spain@eglo.com



SWEDEN
EGLO SVERIGE AB
Honungsgatan 3
S-432 48 VARBERG
T: +46 340 623 505 | F: +46 340 623 605
E: info-sweden@eglo.com



SWITZERLAND
EGLO SCHWEIZ AG
Seetalstraße 142
CH-6032 EMMEN
T: +41 41 268 69 59 | F: +41 41 268 69 58
E: info-switzerland@eglo.com



TURKEY
Eglo Aydınlatma ithalat ihracat Ltd. Şti.
Eyüp Sultan Mah. Sekmen Cad. No:18/2
34855 SAMANDIRA, SANCAKTEPE / İSTANBUL
T: +90 216 311 09 -02 / -03 / -04 | F: +90 216 311 09 -05
E: info-turkey@eglo.com



USA
EGLO USA, INC.
3640 Royal South Parkway
ATLANTA, GEORGIA 30349
T: +1 404 477 5601 | F: +1 404 393 7053
E: info-usa@eglo.com



UKRAINE
EGLO UKRAINE LTD
bulv. Vatslav Havel 6/7A
UA-03680 KIEV
T: +38 044 463 98 41 | F: +38 044 468 84 67
E: info-ukraine@eglo.com

HOW TO READ

ERKLÄRUNG
COMMENT LIRE

SPARE PARTS
ERSATZTEILE
PARTS DE REMPLACEMENT

If spare parts for product are available they are marked on the photograph with their corresponding article number.

Wenn zu einem Produkt Ersatzteile vorhanden sind, werden diese in der Abbildung mit der entsprechenden Artikelnummer markiert.

Si un produit a des parts de remplacement, elles sont marquées avec le numéro d'article dans la photo.

SERIES NAME
SERIENNAME
NOM DE LA SÉRIE

ARTICLE NUMBER
ARTIKELNUMMER
NUMÉRO D'ARTICLE

DESCRIPTION
BESCHREIBUNG
DESCRIPTION

The product description is composed as follows:
luminaire type; enclosure material, enclosure colour / glass or shade material, glass or shade colour

Die Produktbeschreibung setzt sich wie folgt zusammen:
Leuchtenart; Gehäusematerial, Gehäusefarbe / Schirm- bzw. Glasmaterial, Schirm- bzw. Glasfarbe

La description du produit est composée comme suit:
type de luminaire; matériel de boîtier, couleur de boîtier / matériel de verre ou abat-jour, couleur de verre ou abat-jour

DIMENSIONS
DIMENSIONEN
DIMENSIONS

all dimensions in mm | alle Größen in mm | toutes dimensions en mm

L = length | Länge | longueur

B = width | Breite | largeur

H = height | Höhe | hauteur

Ø = diameter | Durchmesser | diamètre

A = projection length | Ausladung | amplitude

ET = installation depth | Einbautiefe | profondeur utile

Base = base dimensions | Sockelmaße | dimensions de base

Attention! The dimensions relate solely to the sizes of the luminaire. Any air spaces that would be relevant for a safe operating of the lamp were not considered.

Achtung! Die Größen beziehen sich nur auf die Abmessungen der Leuchte. Etwaige Lufträume, die für einen sicheren Betrieb der Leuchte notwendig sind, werden nicht berücksichtigt.



Attention! Les dimensions se réfèrent à la taille de la lampe seulement. Espacements éventuels, que seraient importants pour une opération de la lampe sans danger, n'ont pas été considérés.

PICTOGRAMMES
PIKTOGRAMME
PICTOGRAMMES

Technical details are represented as pictogrammes. An overview over all pictograms can be found on the next pages.

Technische Details werden als Piktogramme dargestellt. Eine Übersicht über alle Piktogramme finden Sie auf den nächsten Seiten.

Les détails techniques sont représentés sous forme de pictogrammes. Vous trouverez un aperçu de tous les pictogrammes dans les pages suivantes.

 <p>97238 VERRES wall light; stainless steel, plastic, stainless steel, white / plastic, white Wandleuchte; Edelstahl, Kunststoff, edelstahl, weiss / Kunststoff, weiss applique; acier inoxydable, plastique, acier inoxydable, blanc / plastique, blanc L 180, H 290, A 90</p> <p>E27 1x 12W IP44</p> <p>9 002759 972387</p> <p>L 180 H 290 A 90</p>	 <p>83433 PARK wall light; cast aluminium, anthracite / satin glass, white Wandleuchte; Aluguss, anthrazit / Glas satiniert, weiss applique; fonte d'aluminium, anthracite / verre satiné, blanc</p> <p>L 200, H 350, A 145</p> <p>E27 1x 60W IP44</p> <p>9 002759 834333</p> <p>L 200 H 350 A 145</p>	 <p>94138 BREGANZO wall light; zinc-plated steel, anthracite / plastic, white Wandleuchte; Stahl verzinkt, anthrazit / Kunststoff, weiss applique; acier galvanisé, anthracite / plastique, blanc</p> <p>L 180, H 250, A 115</p> <p>LED 2x 2,5W 2x 180lm IP44</p> <p>9 002759 941383</p> <p>L 180 H 250 A 115</p>
 <p>97218 MUSSOTTO wall light; stainless steel, plastic, stainless steel, white / plastic, white Wandleuchte; Edelstahl, Kunststoff, edelstahl, weiss / Kunststoff, weiss applique; acier inoxydable, plastique, acier inoxydable, blanc / plastique, blanc L 210, H 305, A 90</p> <p>E27 1x 28W IP44</p> <p>9 002759 972189</p> <p>L 210 H 305 A 90</p>	 <p>96018 BREGANZO 1 wall light; zinc-plated steel, anthracite / plastic, white Wandleuchte; Stahl verzinkt, anthrazit / Kunststoff, weiss applique; acier galvanisé, anthracite / plastique, blanc</p> <p>L 190, H 300, A 125</p> <p>LED 2x 2,5W 2x 180lm IP44</p> <p>9 002759 960186</p> <p>L 190 H 300 A 125</p>	 <p>96017 BREGANZO 1 wall light; zinc-plated steel, silver / plastic, white Wandleuchte; Stahl verzinkt, silber / Kunststoff, weiss applique; acier galvanisé, argent / plastique, blanc</p> <p>L 190, H 300, A 125</p> <p>LED 2x 2,5W 2x 180lm IP44</p> <p>9 002759 960179</p> <p>L 190 H 300 A 125</p>

SKETCHES
SKIZZEN
CROQUIS

The sketches state the most meaningful dimensions. If a product is adjustable by will, a turquoise arrow marks this function and only the maximum dimensions are indicated.

Die Bemaßung der Skizzen umfasst jeweils die aussagekräftigsten Größen. Bei verstellbaren Produkten kennzeichnet ein türkiser Pfeil diese Funktion und nur die maximalen Größen werden angegeben.

Les dimensions des croquis comprennent les plus représentatives. Si un produit est réglable au choix, une flèche turquoise affiche cette fonction et rien que les dimensions maximales sont indiquées.



96017

PRODUCT IN THE AMBIANCE
PRODUKTE IM AMBIENTE
PRODUITS DANS L'AMBIENCE

You can find the article number next to each product in the ambiance pictures.

Sie finden die Artikelnummer neben jeder Abbildung des Produktes auf unseren Ambientebildern.

Vous pouvez trouver le numéro d'article à côté de chaque produit dans les images de l'ambiance.

SENSOR INCLUDED
SENSOR INKLUDIERT
SENSOR INCLUS

This symbol indicates luminaires with a sensor. In addition the Detection angle, Reach, Time setting (min./max.) and Response brightness (lx) is indicated.

Ist die Leuchte mit einem Sensor ausgestattet, wird dies durch ein Sensorsymbol gekennzeichnet. Zusätzlich werden Erfassungswinkel, Reichweite, Zeiteinstellung (max./min.) und die Ansprechhelligkeit (lx) angegeben.



















Un produit avec cette symbole ont une détecteur de mouvement. Aussi le angle de détection, la minuterie et Luminosité de déclenchement (lx) sont indiqué.

MODERN | 101





















































LEGEND

PICTOGRAM PIKTOGRAMME PICTOGRAMME

SOCKETS FASSUNGEN DOUILLES

 LED	 G4	 G53
 2G7	 G5	 GU5,3 / MR16
 2G11	 G9	 GU10
 2GX13	 G10Q	 GX53
 E14	 G13	 GY6,35
 E27	 G23	 R7s

BULBS LEUCHTMITTEL AMPOULES











 E14 / C35	 E27 / A60 Halogen	 E27 / E140 Filament
 E14 / C35f	 E27 / R63 Halogen	 E27 / PS160 Filament
 E14 / D45	 E27 / A60 LED	 E27 / T30 Filament
 E14 / C35f LED	 E27 / A60 Filament	 E27 / T32 Filament
 E14 / D45 Halogen	 E27 / A65 LED	 G4 / T9
 E14 / C35 Halogen	 E27 / A75 Filament	 G4 / LT9
 E14 / T22	 E27 / G45 LED	 G4 / LT14
 E14 / C35 Filament	 E27 / G45 Filament	 G9
 E14 / C37 Filament	 E27 / G80 Filament	 G9 LED
 E14 / C35f Filament	 E27 / G95	 GU10
 E14 / C37f Filament	 E27 / G95 Filament	 GU10 LED
 E14 / P45 LED	 E27 / G125	 GU10 SMD LED
 E14 / P45 Filament	 E27 / G95 LED	 GX53 / LF75
 E14 / P50	 E27 / G200 Filament	LED LED board / LED Platine / LED bord
 E14 / ST48 Filament	 E27 / R63 LED	 MR16
 E14 / ST64 Filament	 E27 / ST48 Filament	 MR16 LED
 E14 / T20 LED	 E27 / ST64 Filament	 R7s / 78mm
 E27 / A60	 E27 / B80 Filament	 R7s / 118mm
 E27 / G90	 E27 / BR150 Filament	 R7s / 78mm LED
 E27 / QR63	 E27 / DP165 Filament	 R7s / 118mm LED

LIGHT COLOUR & LUMEN
LICHTFARBE & LUMEN
COULEUR LUMINEUX & LUMEN

















The colours of the LED are represented as pictograms (see below), their luminous flux directly beneath. The luminous flux is quoted in lumen and describes the amount of light generated by the LED. The higher the value, the brighter is the lamp. Lumens are LED boards and are the light measurement value in bulbs.

Die Farben der LED werden als Piktogramm (siehe unten) dargestellt, deren Lichtstrom direkt darunter. Der Lichtstrom wird in Lumen gemessen und gibt die erzeugte Lichtmenge der LED an. Je höher der Wert, desto heller das Produkt. Lichtstromangaben (Lumen) sind Platinen- bzw. Leuchtmittelwerte.



















Les couleurs de LED ont représentés sous forme de pictogrammes, leur flux lumineux directement en dessous. L'unité de flux lumineux est le lumen et il mesure la quantité de lumière générée par les LED. Plus la valeur est élevée, plus la lampe est lumineuse. Les lumens sont l'unité de mesure de l'intensité lumineuse des ampoules et des panneaux led intégrés.

	RGB RGB RGB		RGB + tunable white RGB + tunable white RGB + tunable white
	RGB + white RGB + weiß RGB + blanc		tunable white tunable white tunable white
	RGB + warmwhite RGB + warmweiß RGB + blanc chaud		warm white warmweiß blanc chaud
	RGB + coldwhite RGB + kaltweiß RGB + blanc froid		cold white kaltweiß blanc froid
	RGB + neutralwhite RGB + neutralweiß RGB + blanc neutre		neutral white neutralweiß blanc neutre

SWITCHES & SENSORES
SCHALTER & SENSOREN
INTERRUPTEUR & CAPTEURS

	incl. cable & plug inkl. Kabel & Stecker câble & connecteur inclus		pedal switch Trittschalter interrupteur à pied		swedish plug Stecker Schweden connecteur suède
	internal dimmer eingebauter Dimmer variateur intégré		cable switch Kabelschalter interrupteur à câble		"Touch me" ON/OFF "Touch me" EIN/AUS "Touch me" ON/OFF
	button switch Druckknopf interrupteur de pression		incl. cable & plug transformer inkl. Kabel & Stecktransformator câble & transformateur à prise		"Touch me" ON/OFF & dimm "Touch me" EIN/AUS & Dimmen "Touch me" ON/OFF & graduable
	function switch Funktionsschalter interrupteur fonction		remote control Fernbedienung télécommande		pull switch Zugschalter interrupteur à bascule
	rocker switch Wippschalter interrupteur à bascule		Day & Night Sensor Tag & Nacht Sensor sensor jour & nuit		Timer - automatic on/off Zeitschaltuhr - automatisches Ein- & Ausschalten minuterie - peut être éteint et allumé automatiquement
	pedal dimmer Trittdimmer variateur à pied		sensor Sensor sensor		

FUNKTIONEN & KOMFORT
FUNKTIONEN & KOMFORT
FONCTIONS & CONFORT



	incl. battery inkl. Akku incl. pile		cutout (in mm) Ausschnitt (in mm) perçage du panneau (en mm)		packaging / delivery unit Verpackungs- / Liefereinheit unité d'emballage / de livraison
	incl. battery inkl. Batterie incl. pile		dimmmable dimmmbar mit externen Dimmer graduabile		shortable kürzbar réductible
	battery specifications Batteriespezifikationen spécifications des piles		not dimmmable nicht dimmmbar ne pas graduabile		Voltage Volt Voltage
	beam angle Ausstrahlwinkel angle de rayonnement		Can be operated via control unit Bedienbar über Steuergerät Peut être commandé par une unité de contrôle		Watt
	corner mount possible Eckmontage möglich montage en coin possible		replaceable LED austauschbare LED LED remplaçables		USB connection USB-Anschluss Connexion USB
	Colour Rendering Index		loadable in kg belastbar in kg chargeable en kg		Qi-Charger

PROTECTION CLASS
SCHUTZKLASSE
CLASSE DE PROTECTION

The protection class indicates to what extent the lamp is protected against electric shock. All lamps in this catalogue are at least protected with the protection class 1 - a higher class is specified in the information box of the respective lamp.

Die Schutzklasse gibt an, inwiefern ein Produkt gegen einen elektrischen Schlag gesichert ist. Alle Leuchten in diesem Katalog sind mit mindestens Schutzklasse 1 gesichert, bei höheren Klassen wird das Symbol im Infokasten der Leuchte angegeben.

La classe de protection indique, dans quelle mesure la lampe est protégée contre les chocs électriques. Tous les lampes dans ce catalogue sont protégées au moins avec la classe 1 - une classe plus élevée est indiquée dans l'information de la lampe.

	protection class 1: protective earthing Schutzklasse 1: Schutzerdung classe de protection 1: prise de terre		protection class 2: protective insulation Schutzklasse 2: Schutzisolation classe de protection 2: double isolation ou renforcée		protection class 3: protective low voltage Schutzklasse 3: Schutzkleinspannung classe de protection 3: très basse tension de sécurité
--	---	---	---	---	---

PROTECTION RATING
SCHUTZGRAD
INDICE DE PROTECTION

The protection rating ensures the operational safety of luminaires. The first number specifies the extent of the protection against the ingress of foreign bodies; the second number identifies the humidity protection grade. All luminaires in this catalogue are at least protected with the rating IP20 - a higher rating is specified in the information box of the luminaire.

Der Schutzgrad gewährleistet die Betriebssicherheit von Leuchten. Die erste Ziffer des IP Grades beschreibt den Schutzzumfang gegen das Eindringen von Fremdkörpern, die zweite Ziffer informiert über den Grad des Feuchtigkeitsschutzes. Alle Leuchten in diesem Katalog sind mit mindestens Schutzgrad IP20 gesichert, bei höheren Graden wird das Symbol im Infokasten der Leuchte angegeben.

L'indice de protection assure la sécurité opérationnelle des luminaires. Le premier chiffre indique à quel point la protection est efficace contre l'insertion de corps étrangers; le second chiffre indique quant à lui le degré de protection par rapport à l'humidité. Tous les luminaires dans ce catalogue sont protégés au moins avec l'indice IP20 - un indice plus élevé est indiqué dans l'information d'article.

	IP33		IP44		IP54		IP65		IP67
--	------	---	------	---	------	--	------	---	------

REGISTER

SERIES NAMES
SERIENNAMEN
NOME DE PRODUITS

name name nom	page seite page	name name nom	page seite page	name name nom	page seite page	name name nom	page seite page
ACATE	80	CITY	103,105	LAMOZZO	170	PALIZZI	172
ADAMELLO	78	CIVIDINO	129	LAMOZZO 1	170	PALOSCO	51
AGOLADA	90	CONNECT REMOTE	16	LATERNA 4	160-161	PARK	100
ALAMONTE	126,129	CONNECT SENSOR	16	LATERNA 5	162-163	PARK 4	191
ALAMONTE 1	126-127	CONNECTOR BOX	191	LEPUS	106	PASSIRANO	99
ALBACETE	143	CORNALE	76	LISIO	135	PASTION	172
ALBENZA	78	CORRIENTES	66	LM_LED_EZ7	20,26,175	PERAFITA	83
ALORIA	150-152	CUBA	192	LM_LED_GU10	25	PERNATE	84
AMAROSI	74	CULPINA	75	LOCANA-C	16	PIAS	80
ARACENA	188-189	DARIL 1	104	LUNANO	174	PILONE	73
ARGOLIS	70,72	DESELLA 1	115	MADRIZ	68	PINEDA-IP	190
ARGOLIS-C	17	DETECT ME 1	177	MANERBIO	158	PIOVE-C	16
ATOLLARI	94	DETECT ME 3	176	MANFRIA	46	POLIENTO	65
AZZINANO	81	DETECT ME 4	176	MARCHESA	72	PRATA VECCHIA	57
BARROSELA	140,142	DETECT ME 5	175	MARCHESA-C	19	PREDAZZO	87
BASALGO 1	60	DETECT ME 6	176	MARGO	190	PULFERO	140
BELCREDA	116	DONATORI	56	MELGOA	140,142	PULFERO 1	143
BEVERLY	88	DONINNI 1	48-49	MELZO	52	RALORA	81
BEVERLY 1	118	EGLO CONNECT	15,24	MILTON	107,142	RAVELLO	130
BOSARO	84	EMOLLIO	117	MIRANDOLA	128	REDONDO	86
BOVOLONE	144	ENTRIMO	107,144	MONGODIO	73	RIFORANO	42
BREGANZO	100	EREDITA	78	MONREALE	146,148	RIGA	91
BREGANZO 1	100	FAEDO 3	180,182,184-185	MONTEROLO	196	RIGA 3	187
BRIANZA	50	FAEDO 4	178-179	MONTEROLO-C	24-25	RIGA 5	93
BRIONES	118	FANTECOLO	89	MONTEROS	77	RIGA-LED	92
CALDIERO	58	FIUMICINO	54	MORINO	86	ROBLEDO	88
CALDIERO-C	21	FRANCARI	84	MUSSOTTO	100	RUBIO	66
CALGARY 1	80	FRANCARI-C	19	NADELA	78	SAKEDA	112
CALPINO	114	GORZANO	86	NAVEDO	154,156-158	SALVANESCO	74
CANOVE	140	HELSINKI	62-63	NEMA	178	SAN TELMO	143
CASABAS	168,172	HILBURN	138	NEMA 1	178	SESIMBA	96
CASAZZA	69	HILBURN 1	138	NEMA 1-C	25	SESIMBA 1	96
CASCINETTA	125	INFESTO 1	71	NEMBRO	44	SEVILLA	107
CERNO	103,105	IPHIAS	113	NISIA	64	SIDNEY	134
CHEIRA	118	JORBA	82	NISIA-C	22	SIRMIONE	132
CHINOA	99	KIBEA	78	ONCALA	64	SITIA	79
CISTIerna	95	LAGASCO	87	ONJA	106	SONCINO	128
CISTIerna 1	95	LAMEDO	186	PAGINO	168	SONELLA	70

name name nom	page seite page
SORRONARO	67
SOSSANO	136
SPINETOLI	179
STOCKHOLM 1	88
TABO	80
TAVERNA	136
TONEGO	92
TORAZZA-C	18
TRECATE	144
TREVILO	98
TREVILO 1	98
TRIBANO	102
TRONO STICK	89
TRONTO	186
VALDEO	143-144
VENTO 1	73
VENTO 2	73
VERRES	100
VERRES-C	20
VILLAGRAZIA	124
ZIMBA	188
ZIMBA-LED	188-189



REGISTER

ARTICLE NUMBER
ARTIKELNUMMER
NUMÉROS D'ARTICLE

Number nummer Numéro	page seite page	Number nummer Numéro	page seite page	Number nummer Numéro	page seite page	Number nummer Numéro	page seite page	Number nummer Numéro	page seite page	Number nummer Numéro	page seite page	Number nummer Numéro	page seite page
11585	15	86541	88	93459	154	95016	65	97247	22	98091	74	98701	56
11586	24	87105	134	93462	154	95017	65	97248	22	98095	46	98702	56
11684	20	88008	188	93463	156	95079	118	97249	22	98096	46	98703	56
11714	175	88119	107	93464	156	95097	115	97254	73	98097	46	98704	74
11856	25	88139	103	93465	156	95233	189	97258	158	98098	46	98705	74
11864	26	88142	103	93481	186	95235	188	97261	144	98101	196	98706	98
11865	26	88144	103	93482	186	95982	64	97284	102	98102	196	98707	50
12572	26	88152	192	93994	87	95987	79	97285	132	98103	196	98708	50
22144	160	88153	192	94086	81	95988	79	97286	132	98104	196	98709	99
22145	160	88489	107	94092	190	96007	83	97287	132	98105	24	98711	99
22462	162	88575	188	94093	190	96013	88	97288	132	98106	24	98712	73
22463	162	88744	192	94101	91	96017	100	97289	76	98107	24	98713	125
22464	163	89767	106	94102	91	96018	100	97294	128	98108	25	98714	125
22466	163	89768	106	94103	91	96019	96	97295	16	98115	148	98715	125
22467	161	90184	143	94105	91	96021	96	97296	144	98117	148	98716	95
22468	161	90748	191	94106	91	96022	96	97297	118	98118	148	98717	78
22469	161	90867	106	94107	91	96206	107	97299	16	98119	146	98718	104
22471	160	91206	191	94111	178	96207	144	97303	52	98121	146	98719	128
22472	161	91207	191	94114	80	96239	144	97304	52	98122	146	98721	130
22995	162	92736	92	94121	73	96241	143	97307	84	98123	146	98722	130
22996	162	93094	152	94127	89	96255	82	97308	84	98143	77	98723	130
27126	64	93095	152	94128	89	96256	82	97311	116	98145	19	98724	130
30184	135	93096	152	94138	100	96262	143	97312	116	98147	72	98725	42
30185	135	93097	151	94186	80	96274	117	97339	174	98148	54	98726	42
30187	135	93098	151	94277	60	96276	94	97418	175	98149	54	98727	42
30188	135	93099	151	94278	60	96277	94	97419	175	98151	54	98728	42
30191	103	93254	78	94279	60	96286	112	97421	176	98152	54	98729	99
30192	103	93268	88	94281	60	96287	112	97422	176	98153	124	98731	57
30205	64	93318	86	94779	84	96288	112	97451	58	98154	124	98732	57
30206	64	93319	86	94788	127	96365	73	97453	58	98171	17	98733	57
30207	64	93365	80	94792	140	96415	190	97455	182	98172	17	98736	87
32732	16	93368	86	94796	96	96452	177	97456	182	98173	17	98737	51
32898	93	93384	178	94799	118	96454	177	97457	182	98174	17	98738	51
32899	93	93385	178	94803	90	96488	113	97458	182	98176	168	98739	51
33152	184	93403	152	94804	90	96489	113	97459	180	98177	168	98741	89
33153	184	93404	152	94805	140	96491	72	97461	180	98178	168	98744	129
33154	184	93406	150	94827	129	96492	72	97462	180	98182	186	98745	78
33155	184	93407	151	94831	126	96494	70	97463	180	98184	179	98746	98
33156	185	93408	150	94832	126	96495	70	97464	176	98185	179	98747	98
33157	185	93409	150	94833	126	96505	92	97465	176	98187	172	98748	44
33158	185	93426	191	94841	140	97119	92	97466	176	98189	168	98749	44
33159	185	93438	78	94842	138	97146	58	97467	176	98191	172	98751	44
81751	62	93445	158	94843	138	97147	58	97471	178	98194	168	98757	170
81752	62	93446	158	94845	80	97155	136	97475	16	98195	172	98758	170
81753	63	93447	158	94848	96	97159	81	97482	21	98196	172	99521	69
82309	103	93448	158	94855	143	97218	100	97483	21	98233	84	99522	69
83278	63	93451	158	94858	142	97219	18	97484	21	98234	19	99533	69
83279	62	93452	157	94863	142	97222	86	97485	21	98266	48	99534	69
83281	62	93453	157	94864	138	97226	140	97632	52	98267	48	99565	105
83433	100	93454	157	94865	138	97237	16	98052	25	98268	48	99566	105
83589	142	93455	154	94866	138	97238	100	98085	95	98269	48	99567	105
83966	134	93456	154	94871	70	97239	20	98086	95	98271	48	99568	105
83971	134	93457	154	94872	70	97241	114	98087	75	98272	49	99569	93
86189	187	93458	154	94877	71	97242	114	98088	75	98273	126	99571	93

Number
nummer
Numéro

page
seite
page

99572	66
99573	66
99574	188
99575	188
99576	189
99577	189
99578	67
99579	67
99581	66
99582	66
99583	68
99584	68
99585	78
99586	136
99587	126
99598	136



NOTES

NOTIZEN
NOTES

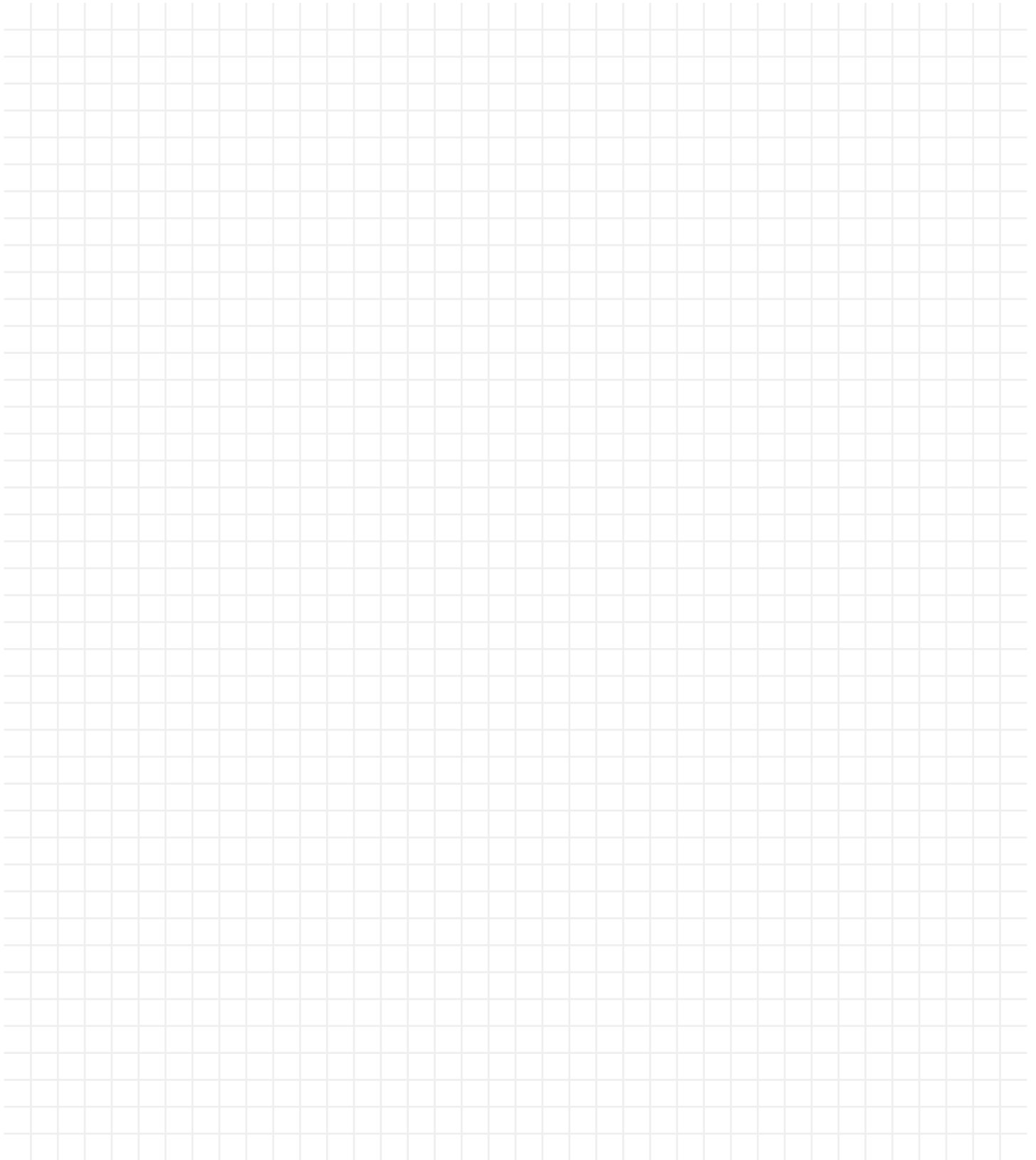

NOTES

NOTIZEN
NOTES

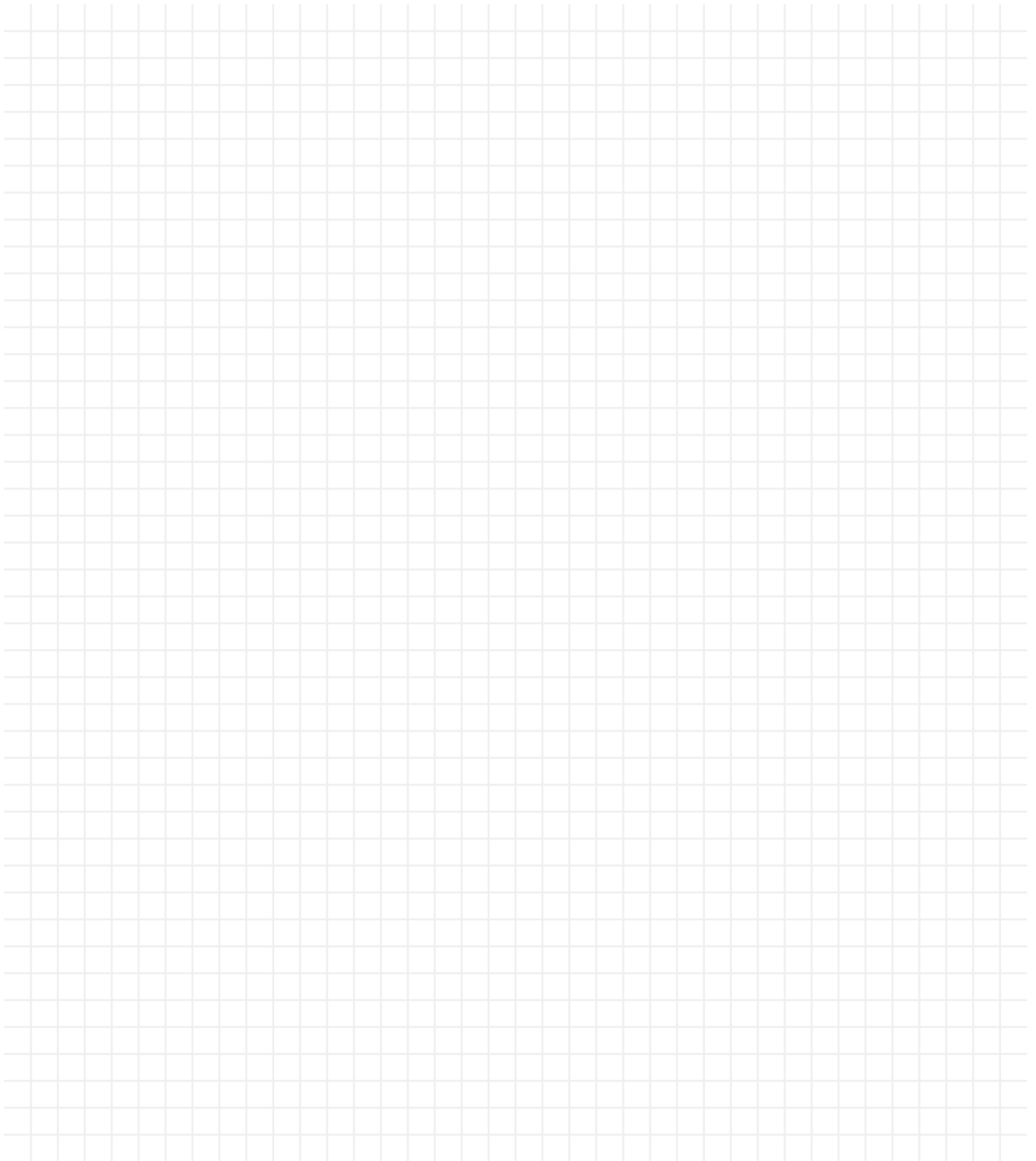

NOTES

NOTIZEN
NOTES

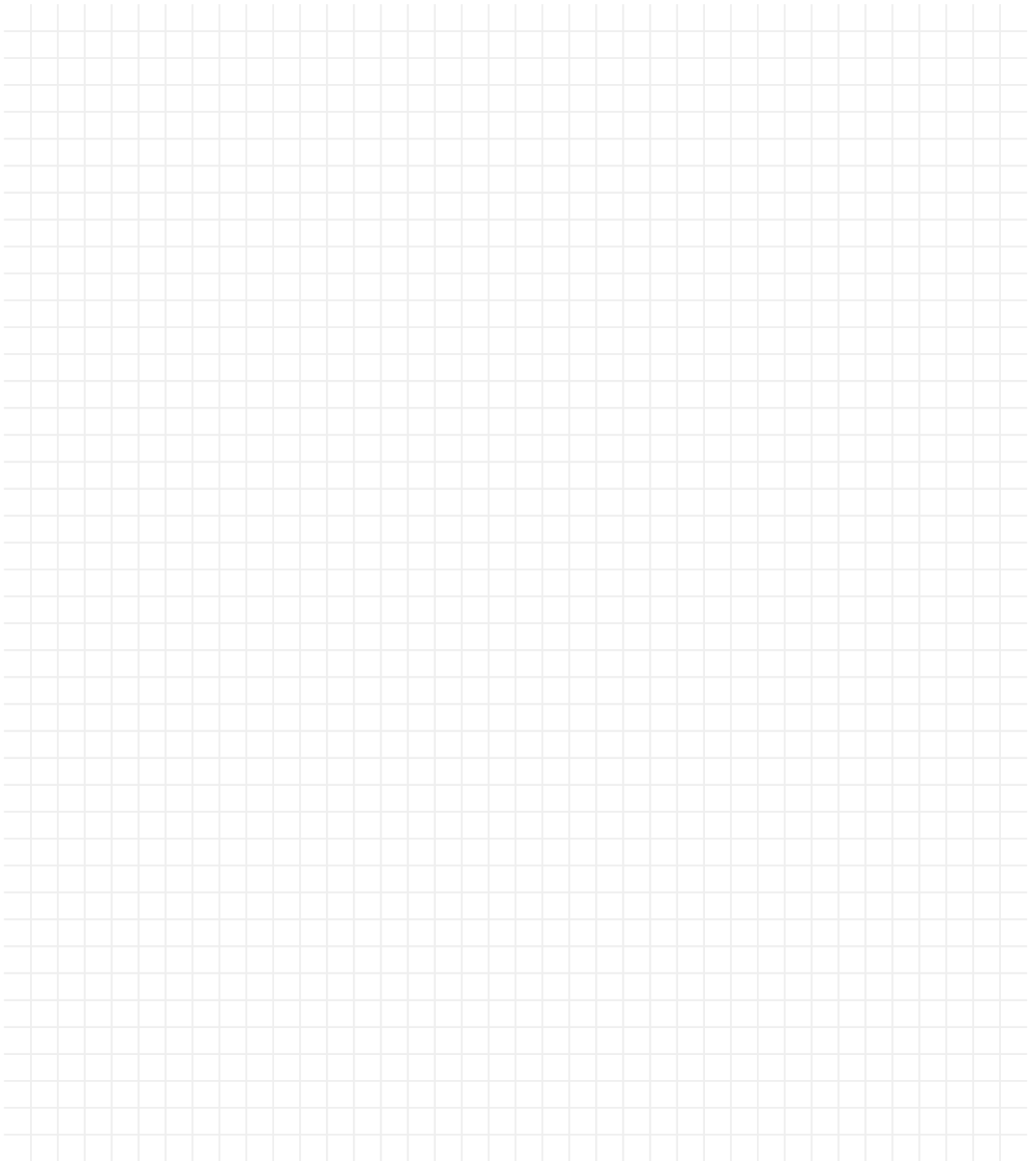

NOTES

NOTIZEN
NOTES

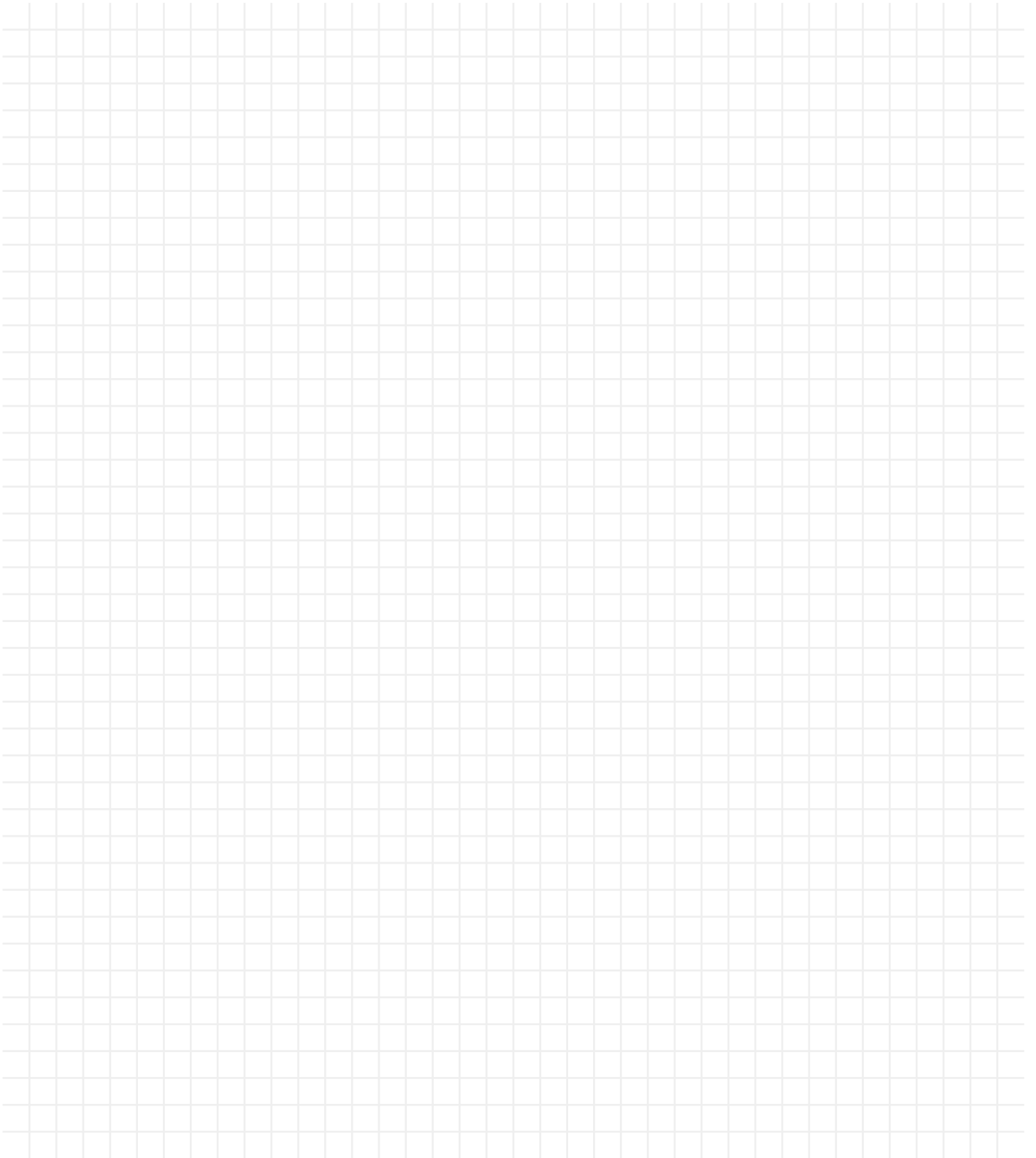

NOTES

NOTIZEN
NOTES

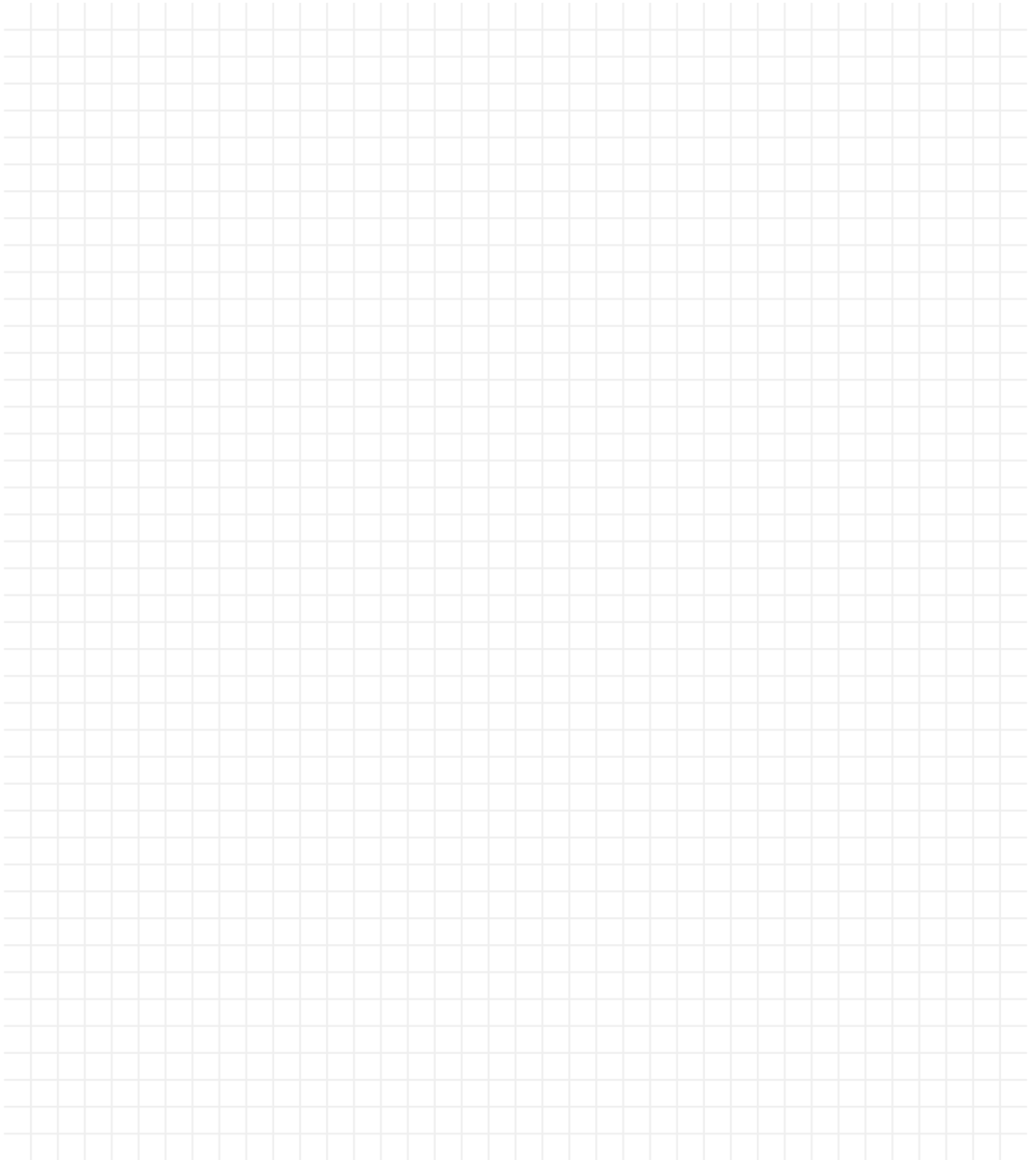

NOTES

NOTIZEN
NOTES

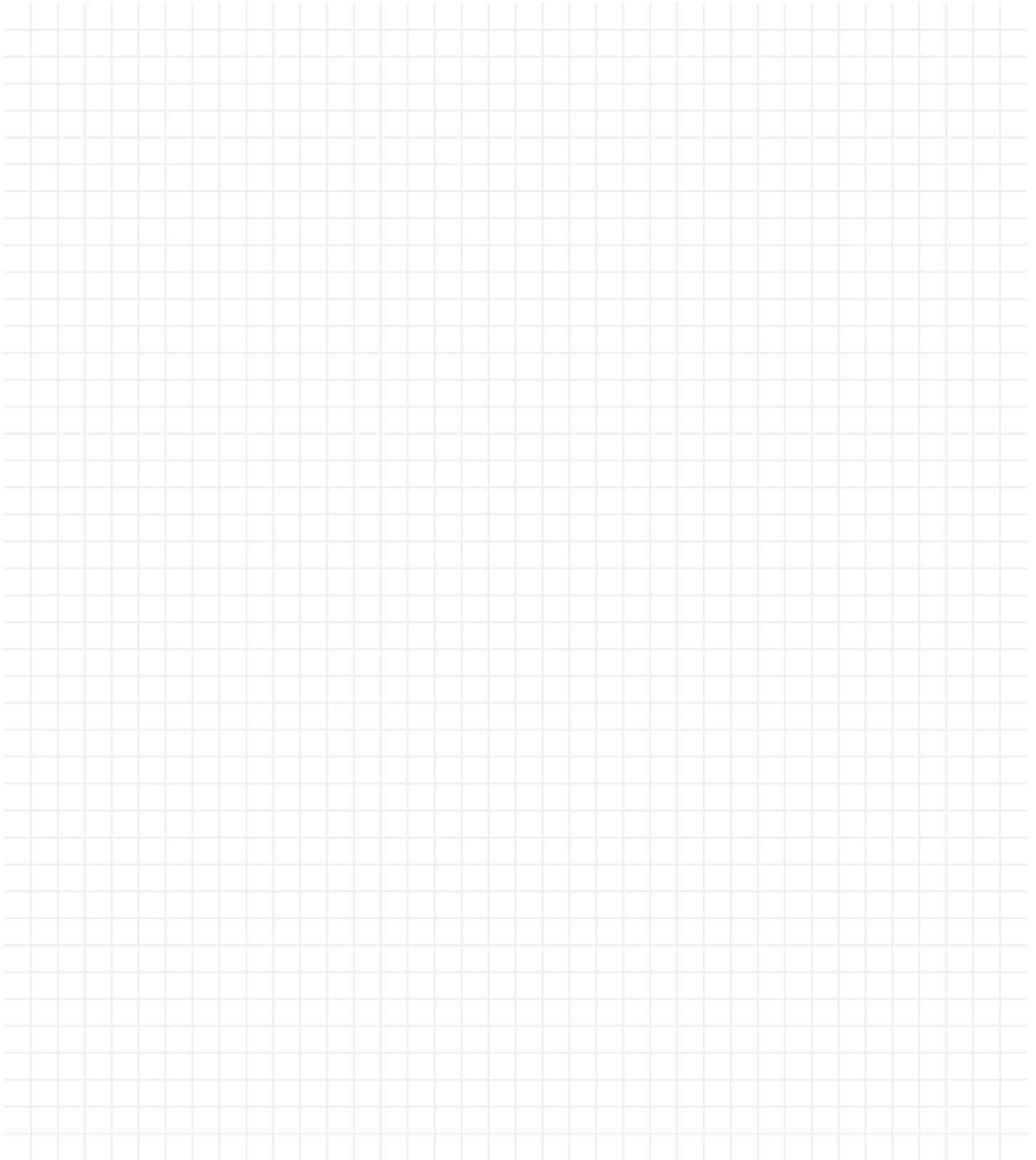

All previous catalogues and price lists are no longer valid with the issue of this catalogue. Errors, misprints, model and price changes and technical modifications are reserved. We deliver based on our terms of delivery and payment. Our products comply with the European light norm EN60598. Products with the ENEC test mark are conforming to the guide line 2006/95/EG. Products with additional safety remarks (e.g protection class, IP) are identified within the product family with the relevant symbol and number. The content of this catalogue is protected under copyright law for EGLO Leuchten GmbH. All rights reserved. Our specific written consent must be obtained before using any illustrations and texts. The pictures are 4C prints and may differ from the original.

The product pictures and ambiances in this catalogue can deviate from reality, and they do not necessarily concur with the usual application of the product. EGLO does not assume liability for the correctness, completeness or the application depiction of the products and/or the product information.

Design, layout and composition: EGLO GmbH, A-6136 Pöll - AUSTRIA

Print: Samson Druck GmbH, 5581 St. Margarethen - AUSTRIA

Pictures: EGLO, Adobe Stock, istockphoto.com

Mit diesem Katalog verlieren alle vorhergehenden Kataloge und Preislisten ihre Gültigkeit. Irrtümer, Druckfehler, Modell- und Preisänderungen sowie technische Änderungen vorbehalten. Wir liefern zu unseren Liefer- und Zahlungsbedingungen. Unsere Produkte entsprechen der europäischen Leuchtnorm EN 60598. Produkte mit dem ENEC Prüfzeichen sind konform mit der Richtlinie 2006/95/EG. Produkte mit weiteren Sicherheitshinweisen (zB. Schutzklasse, IP) sind mit Symbol und Zahl bei der Produktfamilie ausgezeichnet. Der Inhalt dieses Kataloges ist für die EGLO Leuchten GmbH urheberrechtlich geschützt. Alle Rechte sind vorbehalten. Bilder und Texte dürfen nicht ohne vorherige ausdrückliche, schriftliche Genehmigung verwendet werden. Die Abbildungen sind 4C Drucke und können vom Original abweichen.

Die Katalogbilder und die gezeigten Darstellungen der Produkte können von der Wirklichkeit abweichen und nicht den üblichen Produktanwendungen entsprechen. EGLO übernimmt keine Haftung für die Richtigkeit, Vollständigkeit und Anwendungsdarstellung der Produkte und Produktinformationen.

Gestaltung, Layout und Satz: EGLO GmbH, A-6136 Pöll - AUSTRIA

Druck: Samson Druck GmbH, 5581 St. Margarethen - AUSTRIA

Bilder: EGLO, Adobe Stock, istockphoto.com

Le présent catalogue remplace tous les catalogues et tarifs précédents. Sous réserve d'erreurs, de fautes d'impression, de modification des modèles et de changement de prix et de technique. Nous livrons sur la base de nos conditions de livraison et de paiement. Nos produits sont conformes aux normes européennes EN 60598 et portent le marquage CE. Les produits portant la marque ENEC sont conformes à la Directive 2006/95/EG. Les produits portant d'autres indications de sécurité (par exemple classe de protection, IP) sont identifiés par le symbole et le nombre correspondants dans la famille de produits.

Le contenu du présent catalogue est protégé pour la société EGLO Leuchten GmbH par un copyright. Tous droits réservés. Toute reproduction d'images et du texte est interdite sans autorisation explicite par écrit préalable. Les images sont imprimées en 4C et peuvent différer de l'original.

Les images des produits et les ambiances dans le catalogue peuvent dévier de la réalité et ne sont pas nécessairement en ligne avec l'usage habituel du produit. EGLO n'engage pas sa responsabilité sur la justesse des images et sur les informations relatives à l'usage pouvant être fait des produits.

Conception, maquette et composition: EGLO GmbH, A-6136 Pöll - AUSTRIA

Presse: Samson Druck GmbH, 5581 St. Margarethen - AUSTRIA

Images: EGLO, Adobe Stock, istockphoto.com

12-2020



EGLO
my light | my style

EGLO Leuchten GmbH
Heiligkreuz 22
A-6136 Pill
Austria
Tel. +43 (0) 5242 6996
Fax +43 (0) 5242 6996-972
info@eglo.com
www.eglo.com

KATA21

my light | my style