



**EGLO**  
my light | my style



**2020/21**

**TECHNICAL LIGHT SOLUTIONS**

TECHNISCHE LICHTLÖSUNGEN  
SOLUTIONS D'ÉCLAIRAGE TECHNIQUE





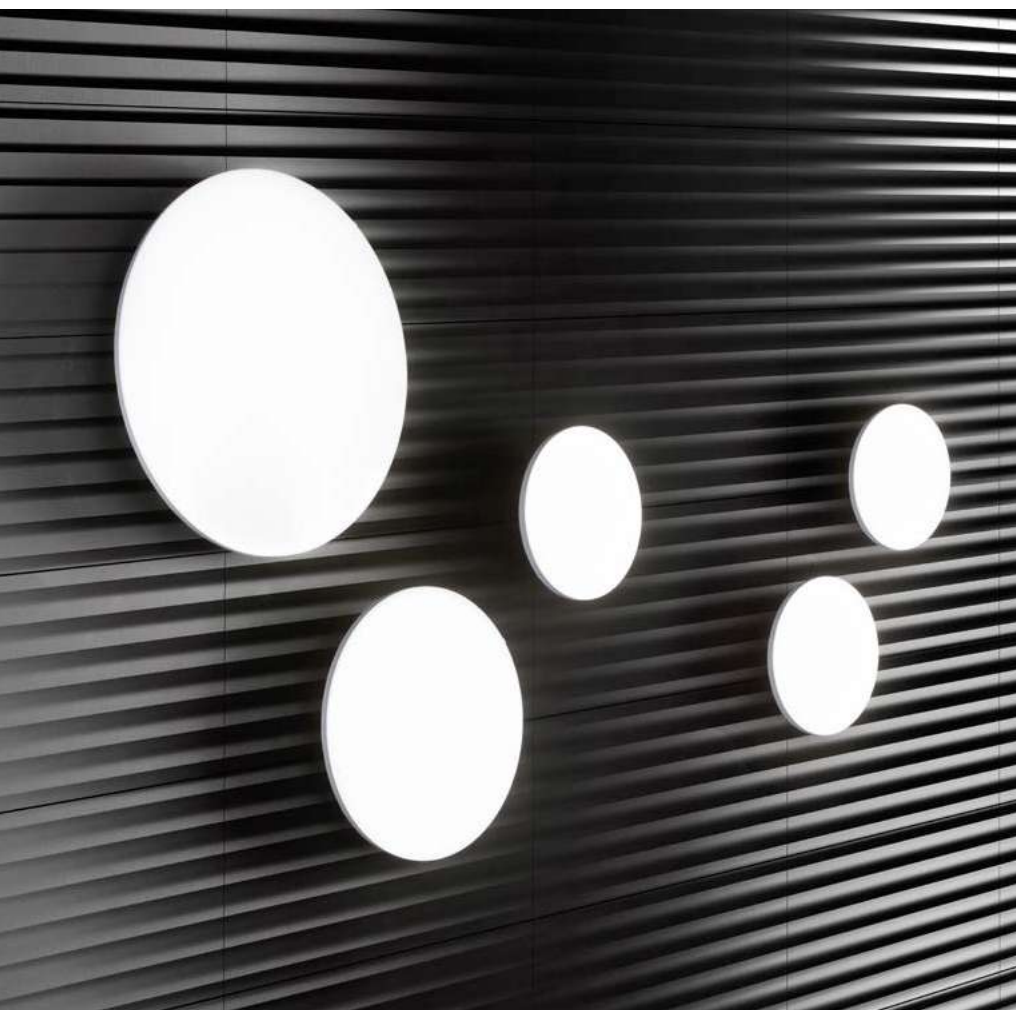

Dear customers and business partners,  
loyal EGLO friends,

the following catalog is devoted specifically to the EGLO technical light solutions. Some products are very discreet in design but all of them are powerful in light staging.

Whether convenient or creative - create your lighting world with the EGLO technical light solutions.

Geschätzte Kunden und Geschäftspartner,  
treue EGLO-Freunde,

im folgenden Katalog hat sich EGLO speziell dem technischen Licht gewidmet. Manche Leuchten sind sehr dezent im Auftritt, doch allesamt sind sie stark in der Lichtinszenierung.

Ob zweckmäßig oder kreativ - schaffen Sie sich Ihre Lichtwelt mit den technischen Lichtlösungen von EGLO.

Très chers clients et partenaires, fidèles amis de EGLO,

le catalogue suivant est consacré spécialement à la lumière technique. Certains luminaires sont très discrets dans la conception, mais tous sont forts dans la création de lumière.

Que ce soit pratique ou créatif - créez votre monde d'illumination avec les solutions de lumière technique d'EGLO.





# CONTENTS

INHALT  
CONTENU

SMART LIGHT	EGLO CONNECT	4-39
	EGLO ACCESS	40-53
RECESSED & SURFACE LUMINAIRES	LED PANEL LUMINAIRES LED PANEELLEUCHTEN LUMINAIRES LAMBRIS LED  DECORATIVE BASIC FRAMELESS WITH SUSPENSION FRAME DIMMABLE	54-89
	RECESSED LUMINAIRES EINBAULEUCHTEN ENCASTRABLES  HIGH VOLTAGE FUEVA 5 LOW VOLTAGE WITH BULBS	90-173
	SURFACE LUMINAIRES AUFBAULEUCHTEN LUMINAIRES EN SAILLIE  FUEVA DECORATIVE	174-221
	LED STRIPES	222-231
	LED PROFILES	232-271
	LEGEND & REGISTER	272-288

# SMART LIGHT

The success of our EGLO connect Smart Lighting System has encouraged us to continue developing luminaires that offer customers the option of individually adjusting the light colour. Since approx. 70% of our Smart Lighting customers use a remote control in spite of apps and voice control assistants, we laid the technological foundation stone for a new lighting system in 2018 that takes this fact into account.

Our luminaire concept EGLO Access will have a radio chipset. Radio technology makes it possible to operate up to eight different luminaires as a group by remote control. Functions such as continuous dimming, setting the light colour, a night light function and two freely programmable favourites complete the range of functions.

Der Erfolg unseres Smart Lighting Systems EGLO connect hat uns dabei bestärkt, weiterhin Leuchten zu entwickeln, die den Kunden die Möglichkeit bieten, die Lichtfarbe individuell einstellen zu können. Da ca. 70% unserer Smart Lighting Kunden trotz App und Sprachsteuerungsassistenten hierbei auf eine Fernbedienung zurückgreifen, wurde von uns im Jahr 2018 der technologische Grundstein für eine neues Leuchtensystem gelegt, das dieser Tatsache Rechnung trägt.

Unser Leuchtenkonzept EGLO Access wird mit einem Funkchipset ausgestattet sein, bei dem die verwendete Funktechnologie es erlaubt, bis zu acht unterschiedliche Leuchten mittels einer Fernbedienung als Gruppe zu bedienen. Funktionen wie stufenlose Dimmbarkeit, das Einstellen der Lichtfarbe, eine Nachtlichtfunktion sowie zwei frei programmierbare Favoriten runden das Funktionsangebot weiter ab.



Le succès de notre système d'éclairage intelligent EGLO connect nous a encouragés à continuer à développer des luminaires qui offrent aux clients la possibilité de régler individuellement la couleur de lumière. Étant donné qu'environ 70 % de nos clients de l'éclairage intelligent utilisent une télécommande malgré l'appli et les assistants de commande vocale, nous avons posé la première pierre technologique d'un nouveau système d'éclairage en 2018 qui tient compte de ce fait.

Notre concept de luminaire EGLO Access sera équipé d'un jeu de puces radio dans lequel la technologie radio utilisée permet de commander jusqu'à huit luminaires différents en groupe au moyen d'une télécommande. Des fonctions telles que la graduation progressive, le réglage de la couleur de lumière, une fonction veilleuse et deux favoris librement programmables complètent l'éventail des fonctions.



















































**Light** takes a  
new direction:  
**Your direction**



# OVERVIEW

							
SALITERAS-C 16	SALITERAS-C 16	TURCONA-C 18	TURCONA-C 18	TURCONA-C 18	TURCONA-C 20	TURCONA-C 20	TURCONA-C 20
							
TURCONA-C 21	TURCONA-C 21	CONNECT REMOTE 22	SARSINA-C 22	SARSINA-C 22	SARSINA-C 23	SARSINA-C 23	SALOBRENA-C 24
							
SALOBRENA-C 24	SALOBRENA-C 24	SALOBRENA-C 25	SALOBRENA-C 25	SALOBRENA-C 26	SALOBRENA-C 26	SALOBRENA-C 26	SALOBRENA-C 27
							
SALOBRENA-C 27	FUEVA-C 28	FUEVA-C 28	FUEVA-C 28	FUEVA-C 29	FUEVA-C 30	FUEVA-C 30	FUEVA-C 30
							
FUEVA-C 31	FUEVA-C 32	FUEVA-C 32	FUEVA-C 33	FUEVA-C 33	FUEVA-C 34	FUEVA-C 34	FUEVA-C 35
							
FUEVA-C 35	FUEVA-C 36	FUEVA-C 36	STRIPE-C 38	STRIPE-C 38			



1



Luminaire / Bulb  
Leuchte / Leuchtmittel  
Luminaire / Ampoules

2



Remote Control / App  
Fernbedienung / App  
Télécommande / App

3



LET'S GO!!!



# EASY, SMART & SAFE

EINFACH, INTELLIGENT & SICHER  
SIMPLE, INTELLIGENT ET SÛR

If you're looking for easy installation and uncomplicated devices, EGLO connect is the right place for you.

Suchst du leichte Installationen und unkomplizierte Geräte - dann bist du bei EGLO connect genau richtig.

Des installations aisées et des appareils simples – EGLO connect est le bon dispositif pour toi.

Starting is made quick and easy, you only need two components:

Der Einstieg ist schnell und einfach, du benötigst nur zwei Komponenten:

Les premiers pas sont simples et rapides, tu as besoin de deux objets :

- › An EGLO connect luminaire / illuminant
- › An EGLO connect remote control or the free AwoX Smart control App

- › Eine EGLO connect Leuchte / Leuchtmittel
- › Eine EGLO connect Fernbedienung oder die kostenlose AwoX Smart control App

- › Une lampe / ampoule EGLO connect
- › Une télécommande EGLO connect ou l'application gratuite AwoX Smart control

## You'll be set to start immediately then!

## Schon kann's losgehen!

## Prêt à te lancer!

The system's basic advantages are:

Die grundlegenden Vorteile des Systems sind:

Les avantages primordiaux du système sont:



### Simple installation

EGLO connect products use Bluetooth technology and do not need any elaborate installations.

### Einfache Installation

EGLO connect Produkte verwenden die Bluetooth Technologie und benötigen keine aufwändigen Installationen.

### Une installation simple

Les produits EGLO connect emploient la technologie Bluetooth et ne nécessitent pas d'installations complexes.



### Smart technology

The EGLO connect items communicate with each other to form a smart, expandable network (MESH technology).

### Smarte Technologie

Die EGLO connect Artikel kommunizieren miteinander und bilden ein intelligentes, erweiterbares Netzwerk (MESH-Technologie).

### Une technologie intelligente

Les articles EGLO connect communiquent les uns avec les autres et forment un réseau intelligent et extensible (technologie MESH).



### Protected network

All EGLO connect products in your home form a closed network and are secured against third-party access.

### Geschütztes Netzwerk

Alle EGLO connect Produkte in deinem Zuhause bilden ein geschlossenes Netzwerk und sind vor fremdem Zugriff gesichert.

### Un réseau protégé

Tous les produits EGLO connect dans ton foyer forment un réseau fermé et sont ainsi protégés des accès étrangers.

# GROWS & LEARNS

WÄCHST & LERNT  
APPRENDRE ET ÉVOLUER

EGLO connect grows to match your needs:

## **BASIC USER:**

Use the EGLO connect remote control together with the EGLO connect lamps / luminaires to adjust brightness, colours and mood. These functions are practical, easy to handle and will meet your daily needs.

## **ADVANCED USER:**

Use the App and expand your options: Combine living areas into groups to control lighting and other devices practically and quickly. Add to the experience of a movie night with the matching light scenario.

## **POWER USER:**

Use the full potential of EGLO connect and the PLUG PLUS: Away from-Home control by integration in your WiFi, control by speech commands via Amazon Echo and Google Home, Day & Night function including motion detection and much more – the future of lighting in your home.

EGLO connect wächst mit deinen Bedürfnissen:

## **BASIC USER:**

Du nutzt die EGLO connect Fernbedienung zusammen mit den EGLO connect Leuchtmitteln / Leuchten. Damit stellst du Helligkeit, Farbe und Stimmung ein. Diese Funktionen sind praktisch, einfach zu handhaben und genügen deinen täglichen Bedürfnissen.

## **ADVANCED USER:**

Du nutzt die App und erweiterst deinen Spielraum: Fasse Wohnbereiche zu Gruppen zusammen, um Licht und andere Geräte praktisch und schnell ansteuern zu können. Verstärke das Erlebnis eines Filmabends mit dem passenden Lichtszenario.

## **POWER USER:**

Du nutzt das volle Potential von EGLO connect und dem PLUG PLUS. Away from-Home control durch Intergration in dein W-Lan, Steuerung per Sprachbefehl mit Hilfe von Amazon Echo und Google Home, Day & Night Funktion inklusive Bewegungserkennung und vieles mehr – Lichtzukunft in deinem Heim.

EGLO connect évolue avec tes besoins:

## **UTILISATEUR DE BASE:**

Tu utilises la télécommande EGLO connect conjointement avec les ampoules/luminaires EGLO connect. Tu régles ainsi la luminosité, la couleur et l'ambiance. Ces fonctions sont pratiques, faciles à manier et suffisent à tes besoins au quotidien.

## **UTILISATEUR AVANCÉ:**

Tu utilises l'application et accrois ta marge de manoeuvre : tu rassembles des zones d'habitat en des groupes afin de pouvoir commander la lumière et les autres appareils de manière rapide et pratique. Renforces l'ambiance d'une soirée film par la scénérie lumineuse correspondante.

## **UTILISATEUR PUISSANT:**

Tu utilises l'ensemble du potentiel d'EGLO connect et PLUG PLUS. Un contrôle hors de chez toi par l'intégration dans ton Wi-Fi, un pilotage par commande vocale avec Amazon Echo et Google Home, une fonction jour & nuit avec détection de mouvements et bien d'autres choses - l'avenir de l'éclairage dans ta maison.

# BASIC USER

No WLAN / internet necessary.  
Controllable via a remote control.

Kein Wlan / Internet notwendig.  
Steuerbar mit Fernbedienung.

Pas de Wifi / Internet nécessaire.  
Commandable par télécommande.

BASIC USER EQUIPMENT

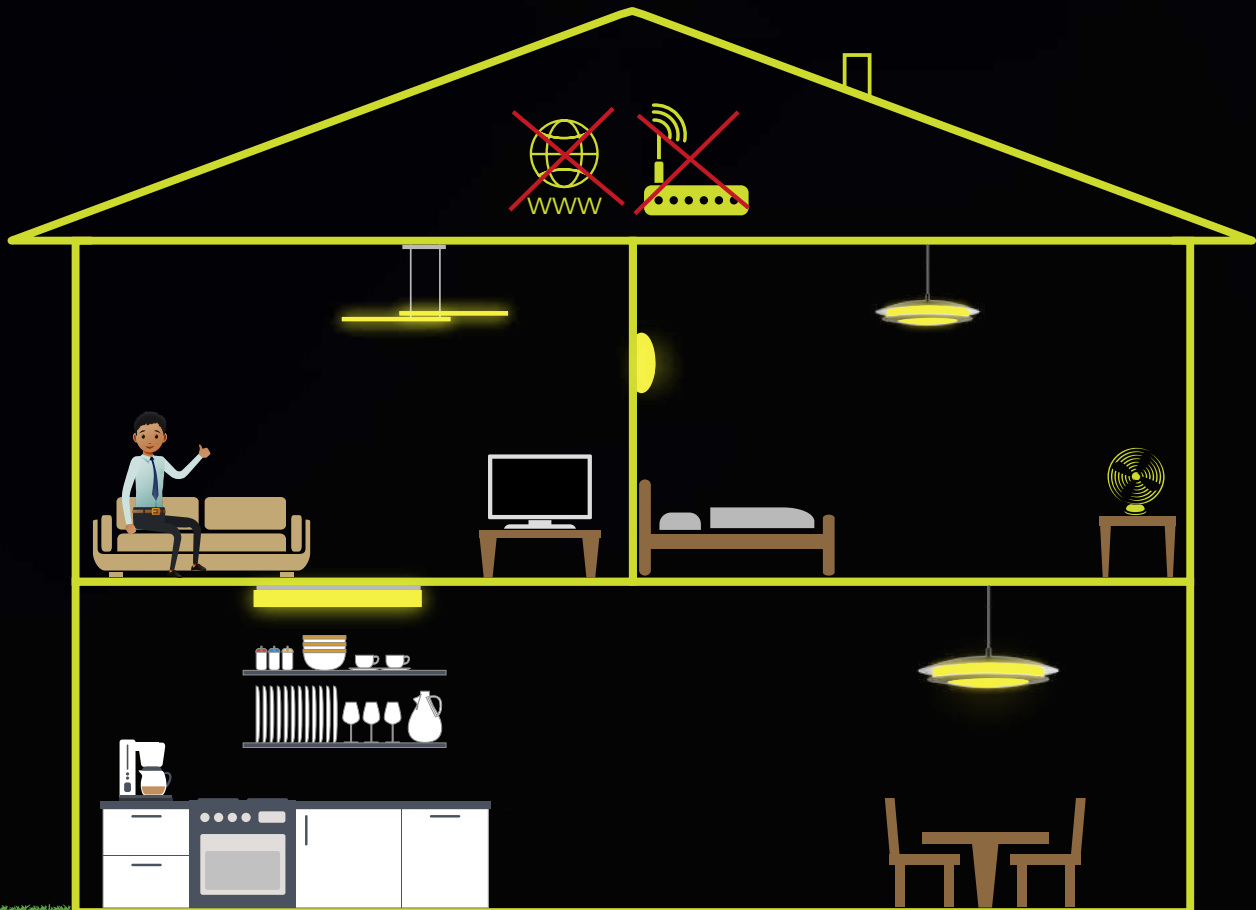



# ADVANCED USER

Internet connection only needed for the installation of the app, registration and updates.

Controllable via smartphone / tablet (app) and remote control.

Integration of a battery-operated sensor with Day & Night function and motion detection possible.

Internetverbindung wird nur zur App Installation, Registrierung und für Updates benötigt.

Steuerbar mit Smartphone / Tablet (App) und Fernbedienung.

Einbindung eines batteriebetriebenen Sensors mit Day & Night Funktion und Bewegungserkennung möglich.

Connexion Internet requise uniquement pour l'installation de l'appli, l'enregistrement et les mises à jour.

Commandable avec Smartphone / Tablette (appli) et télécommande.

Intégration d'un capteur à batteries avec fonction « Jour et nuit » et détection de mouvement possible.

## ADVANCED USER EQUIPMENT



# POWER USER

You use the full potential of EGLO connect.

The PLUG PLUS allows Alexa, Google Home and your smartphone / tablet to control the system from home or on the road.

Du nutzt das volle Potential von EGLO connect.

Der PLUG PLUS ermöglicht es mithilfe von Alexa, Google Home und deinem Smartphone/Tablet das System von Zuhause oder unterwegs zu steuern.

Vous utilisez tout le potentiel d'EGLO connect.

Le connecteur PLUS permet à Alexa, Google Home et votre Smartphone / Tablette, de commander le système connect de chez vous ou à distance.

## POWER USER EQUIPMENT

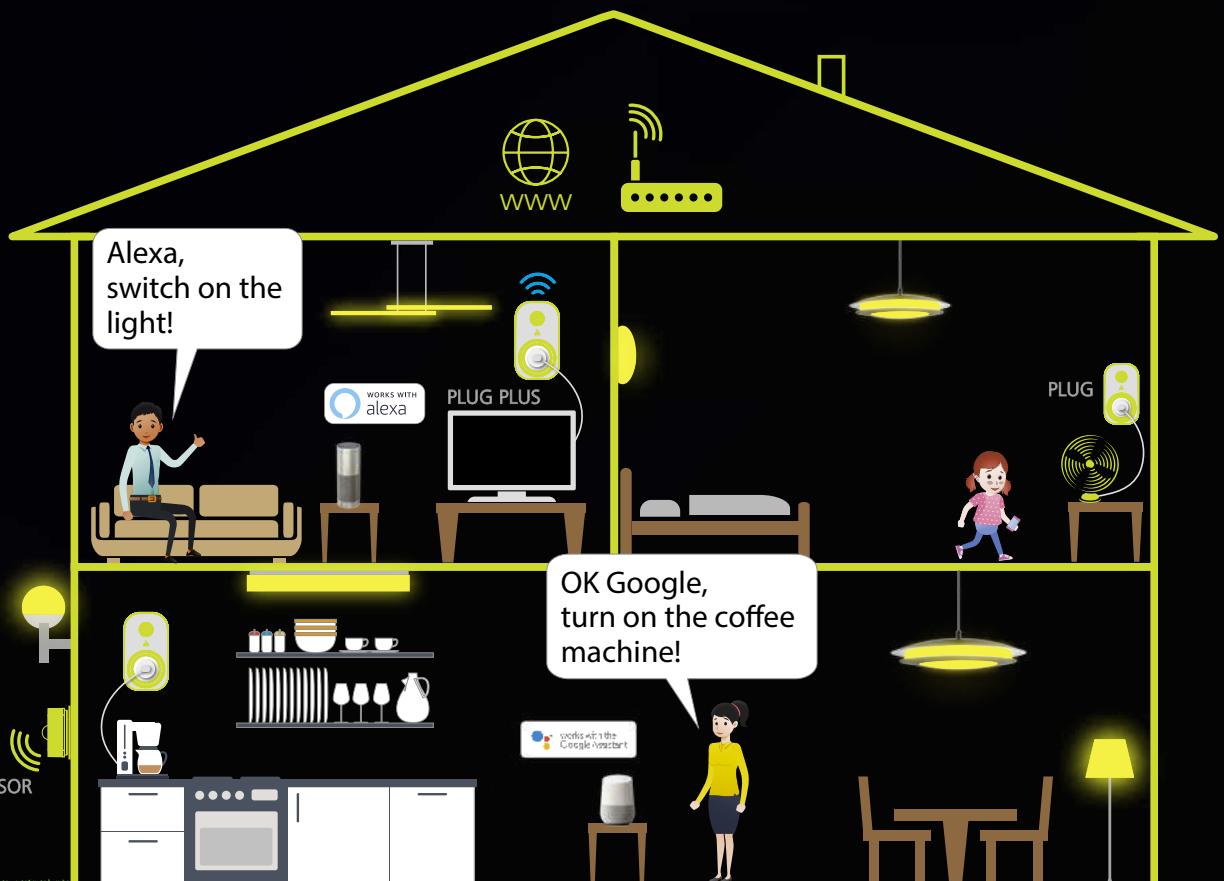







# FUNCTION & CONTROL

FUNKTION & BEDIENUNG  
FONCTION ET COMMANDE



Connect Sensor  
Connect Sensor  
Capteur Connect



Remote control  
Fernbedienung  
Télécommande



App control  
App  
App



CONNECT  
PLUG



CONNECT  
PLUG PLUS



Functions  
Funktionen  
Fonctions

## Basic functions / Grundfunktionen / Fonctions de base

Activation / deactivation Ein- / Ausschalten Allumer / éteindre		•	•	•	•
Motion sensor Bewegungssensor Capteur de mouvements	•				
Light colour regulation Lichtfarben regulieren Réguler les teintes lumineuses		16,7 Mio.	16,7 Mio.		16,7 Mio.
Smooth dimming* Stufenloses Dimmen* Graduation continue*		•	•		
Voice control Sprachsteuerung Commande par la voix			(Siri shortcuts)		•

## Comfort functions / Komfortfunktionen / Fonctions confort

Pre-set scenarios Voreingestellte Szenarien Scéneries prédéfinies			•		
Saving favourites Favoriten speichern Sauvegarder les favoris		2	4		
Grouping lamps Leuchten gruppieren Regroupement des luminaires			•		
Programming function (on / off) Programmierfunktion (Ein / Aus) Fonction de programmation (marche / arrêt)			•	•	•
Dawn simulation Dämmerungssimulation Simulation de crépuscule			•		
Timer function Timer-Funktion Fonction de minuterie			•	•	•
Day & night function Tag & Nacht-Funktion Fonction jour & nuit	•				
Night light Nachtlicht Veilleuse de nuit			•		
Names & pictures for luminaires Namen & Bilder für Leuchten Noms et photos pour les luminaires			•		
Disco function Diskofunktion Fonction disco			•		
BLE Smart Meter function BLE Smart Meter Funktion BLE Fonction smart meter				•	•

\* for EGLO connect luminaires / bulbs only - nur für EGLO connect Leuchten / Leuchtmittel - seulement pour luminaires / ampoules EGLO connect



99412



99411



**99411 SALITERAS-C**

ceiling light; steel, black / plastic, white  
 Deckenleuchte; Stahl, schwarz / Kunststoff, weiss  
 plafonnier; acier, noir / plastique, blanc

L 1160, B 160, H 50

24W  
 2600lm  
 remote, App

**99412 SALITERAS-C**

ceiling light; steel, white / plastic, white  
 Deckenleuchte; Stahl, weiss / Kunststoff, weiss  
 plafonnier; acier, blanc / plastique, blanc

L 1160, B 160, H 50

24W  
 2600lm  
 remote, App

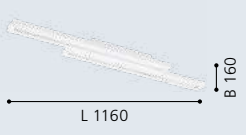
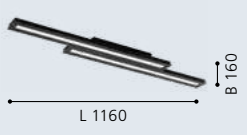

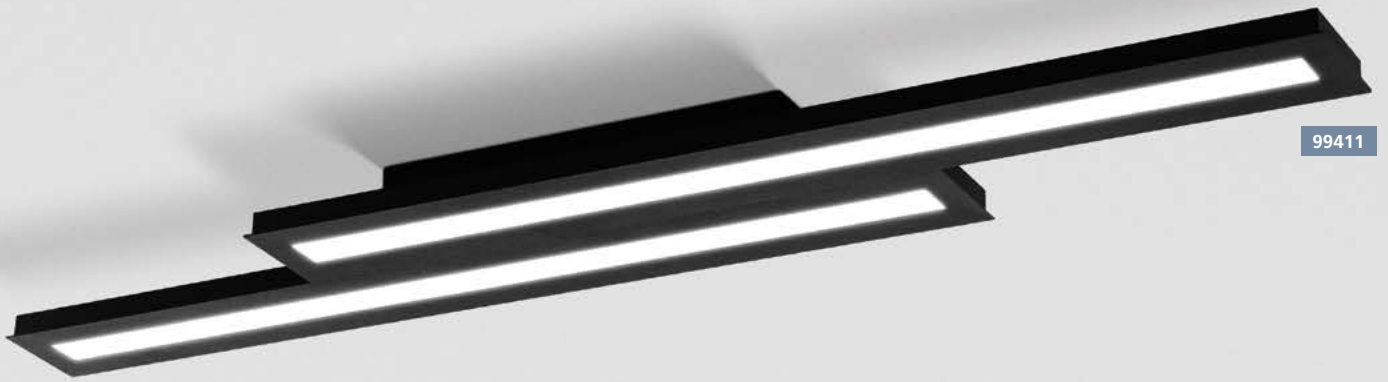

99411





99118, 99119, 99121

Frameless luminaire.  
rahmenlose Leuchte.  
luminaire sans cadre.



99119



incl./inkl./inclus



99118



incl./inkl./inclus



99121



incl./inkl./inclus



99118 TURCONA-C

ceiling light; steel, aluminium, white / plastic, white  
Deckenleuchte; Stahl, Alu, weiss / Kunststoff, weiss  
plafonnier; acier, aluminium, blanc / plastique, blanc

H 60, Ø 300



99119 TURCONA-C

ceiling light; steel, aluminium, white / plastic, white  
Deckenleuchte; Stahl, Alu, weiss / Kunststoff, weiss  
plafonnier; acier, aluminium, blanc / plastique, blanc

H 60, Ø 450



99121 TURCONA-C

ceiling light; steel, aluminium, white / plastic, white  
Deckenleuchte; Stahl, Alu, weiss / Kunststoff, weiss  
plafonnier; acier, aluminium, blanc / plastique, blanc

H 60, Ø 600



9 002759 991180



Ø 300



9 002759 991197



Ø 450



9 002759 991210



Ø 600



99119



Travel makes  
you realize that  
no matter how  
much you know,  
there's always  
more to learn.





### 98562 TURCONA-C

ceiling light; steel, aluminium, white / plastic, white  
 Deckenleuchte; Stahl, Alu, weiss / Kunststoff, weiss  
 plafonnier; acier, aluminium, blanc / plastique, blanc

L 295, B 295, H 60

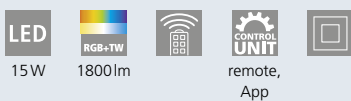

### 98563 TURCONA-C

ceiling light; steel, aluminium, white / plastic, white  
 Deckenleuchte; Stahl, Alu, weiss / Kunststoff, weiss  
 plafonnier; acier, aluminium, blanc / plastique, blanc

L 450, B 450, H 60



### 98564 TURCONA-C

ceiling light; steel, aluminium, white / plastic, white  
 Deckenleuchte; Stahl, Alu, weiss / Kunststoff, weiss  
 plafonnier; acier, aluminium, blanc / plastique, blanc

L 595, B 595, H 60

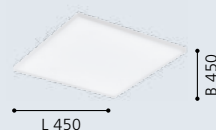
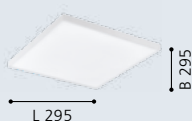



**DIMMABLE  
VIA REMOTE  
AND APP**



98565

LED

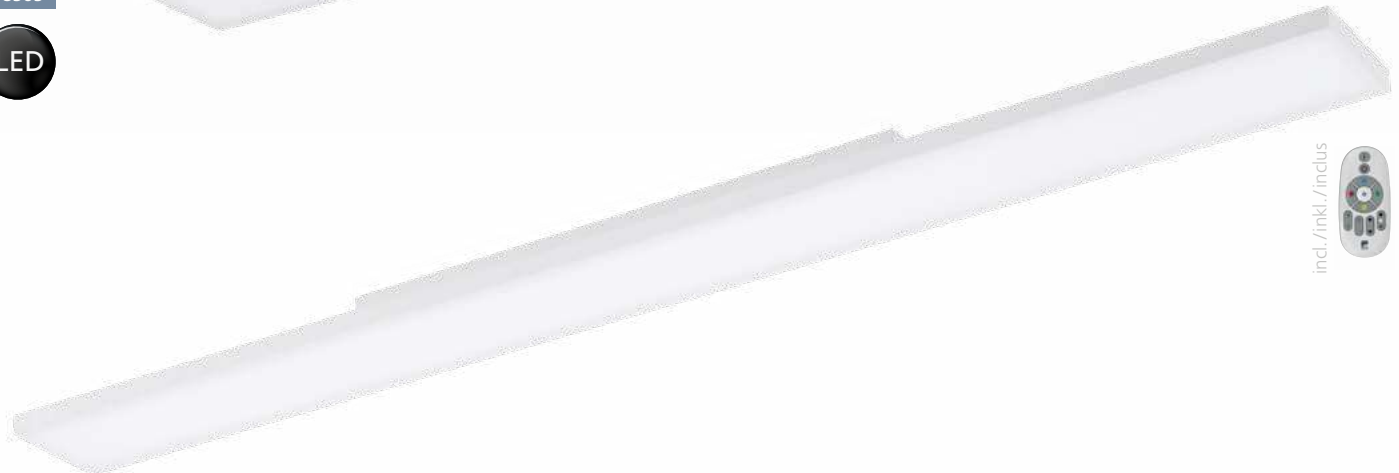

98575

LED

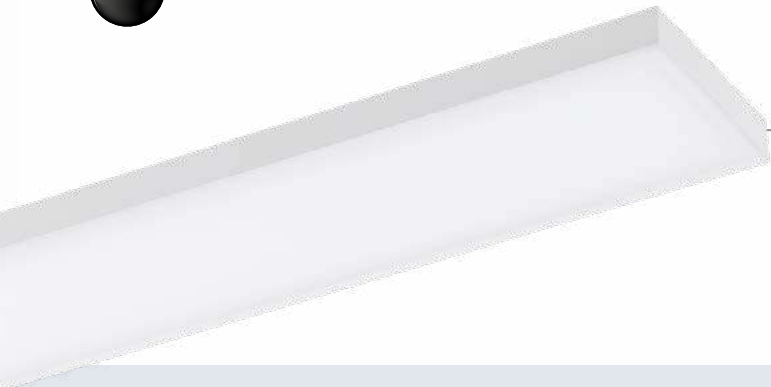

**98562, 98563, 98564,  
98565, 98575**

Frameless luminaire  
Rahmenlose Leuchte  
Luminaire sans cadre

**98565 TURCONA-C**

ceiling light; steel, aluminium, white / plastic, white  
Deckenleuchte; Stahl, Alu, weiss / Kunststoff, weiss  
plafonnier; acier, aluminium, blanc / plastique, blanc

L 1200, B 295, H 60

LED 33W  
 RGB+TW 3300lm  
 remote, App  
 CONTROL UNIT

**98575 TURCONA-C**

ceiling light; steel, aluminium, white / plastic, white  
Deckenleuchte; Stahl, Alu, weiss / Kunststoff, weiss  
plafonnier; acier, aluminium, blanc / plastique, blanc

L 1200, B 100, H 60

LED 33W  
 RGB+TW 3300lm  
 remote, App  
 CONTROL UNIT





97959



incl./inkl./inclus



97958



incl./inkl./inclus



97961



incl./inkl./inclus



32732



incl./inkl./inclus

### 32732 CONNECT REMOTE

remote control; plastic, white  
Fernbedienung; Kunststoff, weiss  
Télécommande; plastique, blanc

L 110, B 53, H 20

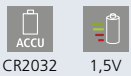

CR2032 1,5V



9 002759 327323



B 53

### 97958 SARSINA-C

ceiling light; aluminium, white / plastic, white  
Deckenleuchte; Alu, weiss / Kunststoff, weiss  
plafonnier; aluminium, blanc / plastique, blanc

H 50, Ø 300



LED 16W RGB+TW 2100lm remote, App



9 002759 979584



Ø 300

### 97959 SARSINA-C

ceiling light; aluminium, white / plastic, white  
Deckenleuchte; Alu, weiss / Kunststoff, weiss  
plafonnier; aluminium, blanc / plastique, blanc

H 50, Ø 450



LED 21W RGB+TW 2900lm remote, App



9 002759 979591

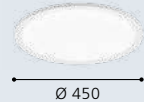

Ø 450



incl./inkl./inclus 

98566

LED



97958

### 97961 SARSINA-C

ceiling light; aluminium, white / plastic, white  
Deckenleuchte; Alu, weiss / Kunststoff, weiss  
plafonnier; aluminium, blanc / plastique, blanc

H 50, Ø 600



34W 4250lm

remote,  
App



9 002759 979614



Ø 600

### 98566 SARSINA-C

ceiling light; steel, white / plastic, white  
Deckenleuchte; Stahl, weiss / Kunststoff, weiss  
plafonnier; acier, blanc / plastique, blanc

H 50, Ø 800

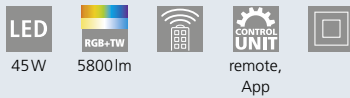

45W 5800lm

remote,  
App



9 002759 985660



Ø 800





incl./inkl./inclus

96662

LED



incl./inkl./inclus

97629

LED



incl./inkl./inclus

96663

LED

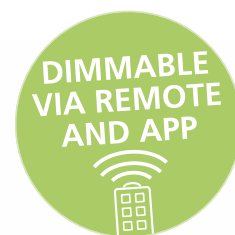

### 96662 SALOBRENA-C

ceiling light; aluminium, white / plastic, white  
Deckenleuchte; Alu, weiss / Kunststoff, weiss  
plafonnier; aluminium, blanc / plastique, blanc

L 300, B 300, H 50

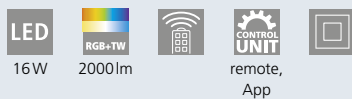

### 97629 SALOBRENA-C

ceiling light; aluminium, white / plastic, white  
Deckenleuchte; Alu, weiss / Kunststoff, weiss  
plafonnier; aluminium, blanc / plastique, blanc

L 450, B 450, H 50



### 96663 SALOBRENA-C

ceiling light; aluminium, white / plastic, white  
Deckenleuchte; Alu, weiss / Kunststoff, weiss  
plafonnier; aluminium, blanc / plastique, blanc

L 595, B 595, H 50



9 002759 966621



9 002759 976293



9 002759 966638





96664

LED



incl./inkl./inclus



98089

LED



incl./inkl./inclus



96664

### 96664 SALOBRENA-C

ceiling light; aluminium, white / plastic, white  
Deckenleuchte; Alu, weiss / Kunststoff, weiss  
plafonnier; aluminium, blanc / plastique, blanc

L 1200, B 300, H 50

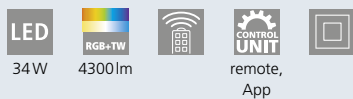

### 98089 SALOBRENA-C

ceiling light; aluminium, white / plastic, white  
Deckenleuchte; Alu, weiss / Kunststoff, weiss  
plafonnier; aluminium, blanc / plastique, blanc

L 1195, B 100, H 45



9 002759 966645

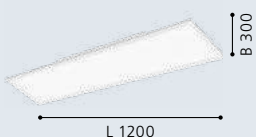

9 002759 980894

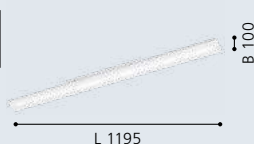



99415

LED

incl./inkl./inclus



99416

LED

incl./inkl./inclus



99417

LED

incl./inkl./inclus



### 99415 SALOBRENA-C

ceiling light; aluminium, black / plastic, white  
Deckenleuchte; Alu, schwarz / Kunststoff, weiss  
plafonnier; aluminium, noir / plastique, blanc

L 300, B 300, H 50

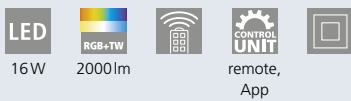

### 99416 SALOBRENA-C

ceiling light; aluminium, black / plastic, white  
Deckenleuchte; Alu, schwarz / Kunststoff, weiss  
plafonnier; aluminium, noir / plastique, blanc

L 450, B 450, H 50



### 99417 SALOBRENA-C

ceiling light; aluminium, black / plastic, white  
Deckenleuchte; Alu, schwarz / Kunststoff, weiss  
plafonnier; aluminium, noir / plastique, blanc

L 595, B 595, H 50



9 002759 994150



9 002759 994167



9 002759 994174

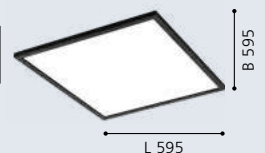





incl./inkl./inclus

99418



incl./inkl./inclus

99414



### 99418 SALOBRENA-C

ceiling light; aluminium, black / plastic, white  
 Deckenleuchte; Alu, schwarz / Kunststoff, weiss  
 plafonnier; aluminium, noir / plastique, blanc

L 1200, B 300, H 50



34W 4300lm

remote, App

### 99414 SALOBRENA-C

ceiling light; aluminium, black / plastic, white  
 Deckenleuchte; Alu, schwarz / Kunststoff, weiss  
 plafonnier; aluminium, noir / plastique, blanc

L 1195, B 100, H 50

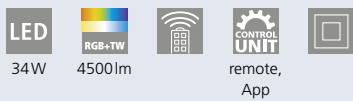

34W 4500lm

remote, App



9 002759 994181

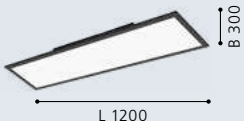

9 002759 994143



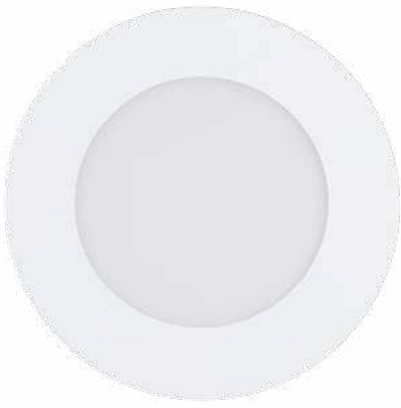

32737

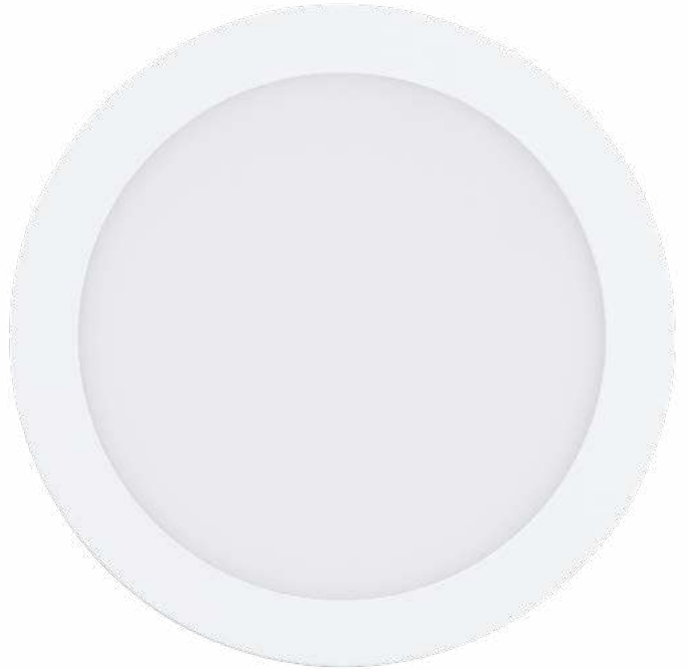

96668

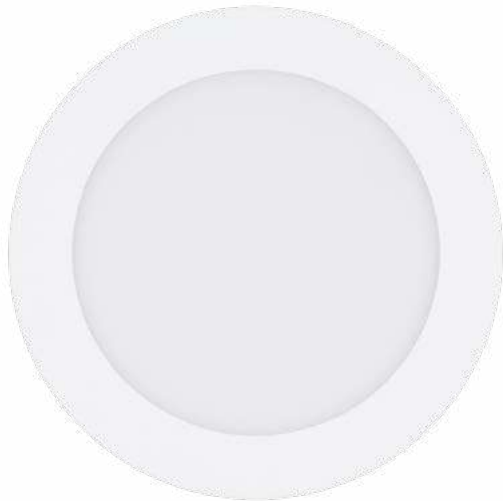

32738



### 32737 FUEVA-C

recessed light; cast metal, white / plastic, white  
Einbauleuchte; Metallguss, weiss / Kunststoff, weiss  
luminaire encastrable; fonte métallique, blanc / plastique, blanc

Ø 120, ET 30



5,4W 700lm remote, App Ø 108

### 32738 FUEVA-C

recessed light; cast metal, white / plastic, white  
Einbauleuchte; Metallguss, weiss / Kunststoff, weiss  
luminaire encastrable; fonte métallique, blanc / plastique, blanc

Ø 170, ET 30

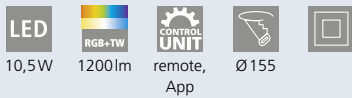

10,5W 1200lm remote, App Ø 155

### 96668 FUEVA-C

recessed light; cast metal, white / plastic, white  
Einbauleuchte; Metallguss, weiss / Kunststoff, weiss  
luminaire encastrable; fonte métallique, blanc / plastique, blanc

Ø 225, ET 30

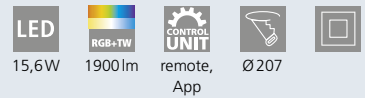

15,6W 1900lm remote, App Ø 207



9 002759 327378



Ø 120



9 002759 327385



Ø 170



9 002759 966683



Ø 225

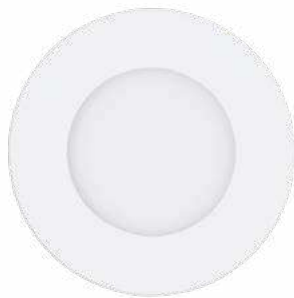
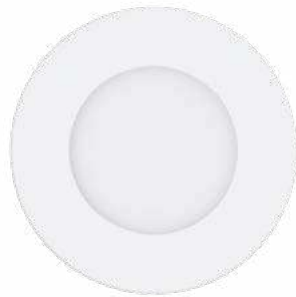

32881



32881

### 32881 FUEVA-C

recessed light; cast metal, white / plastic, white  
Einbauleuchte; Metallguss, weiss / Kunststoff, weiss  
luminaire encastrable; fonte métallique, blanc / plastique, blanc

Ø 85, ET 30

3x 3W	3x 360lm	remote, App		







32753



96676



32754



### 32753 FUEVA-C

recessed light; cast metal, satin nickel / plastic, white  
Einbauleuchte; Metallguss, nickel-matt / Kunststoff, weiss  
luminaire encastrable; fonte métallique, nickel mat / plastique, blanc

Ø 120, ET 30



5,4W 700lm remote, App Ø 108

### 32754 FUEVA-C

recessed light; cast metal, satin nickel / plastic, white  
Einbauleuchte; Metallguss, nickel-matt / Kunststoff, weiss  
luminaire encastrable; fonte métallique, nickel mat / plastique, blanc

Ø 170, ET 30

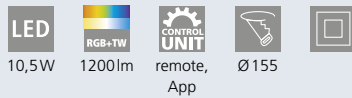

10,5W 1200lm remote, App Ø 155

### 96676 FUEVA-C

recessed light; cast metal, satin nickel / plastic, white  
Einbauleuchte; Metallguss, nickel-matt / Kunststoff, weiss  
luminaire encastrable; fonte métallique, nickel mat / plastique, blanc

Ø 225, ET 30

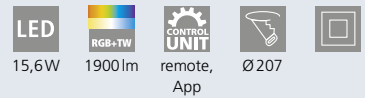

15,6W 1900lm remote, App Ø 207



9 002759 327538



Ø 120



9 002759 327545



Ø 170



9 002759 966768



Ø 225



32882

LED



96676

### 32882 FUEVA-C

recessed light; cast metal, satin nickel / plastic, white  
Einbauleuchte; Metallguss, nickel-matt / Kunststoff, weiss  
luminaire encastrable; fonte métallique, nickel mat / plastique, blanc

Ø 85, ET 30

LED

3x 3W



3x  
360lm



remote,  
App



Ø 74



Ø 85



96669



96671



### 96669 FUEVA-C

surface-mounted light; cast metal, white / plastic, white  
 Aufbauleuchte; Metallguss, weiss / Kunststoff, weiss  
 luminaire en saillie; fonte métallique, blanc / plastique, blanc

H 40, Ø 225

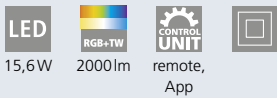

15,6W 2000lm remote, App

### 96671 FUEVA-C

surface-mounted light; cast metal, white / plastic, white  
 Aufbauleuchte; Metallguss, weiss / Kunststoff, weiss  
 luminaire en saillie; fonte métallique, blanc / plastique, blanc

H 40, Ø 300

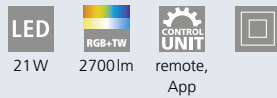

21W 2700lm remote, App

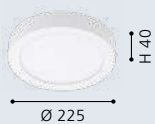





96672

LED



96673

LED

### 96672 FUEVA-C

surface-mounted light; cast metal, white / plastic, white  
 Aufbauleuchte; Metallguss, weiss / Kunststoff, weiss  
 luminaire en saillie; fonte métallique, blanc / plastique, blanc

L 225, B 225, H 40

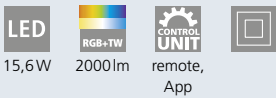

15,6W 2000lm remote, App

### 96673 FUEVA-C

surface-mounted light; cast metal, white / plastic, white  
 Aufbauleuchte; Metallguss, weiss / Kunststoff, weiss  
 luminaire en saillie; fonte métallique, blanc / plastique, blanc

L 300, B 300, H 40

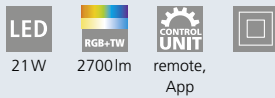

21W 2700lm remote, App

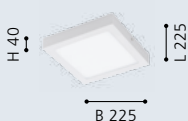



96677

LED



96678

LED

### 96677 FUEVA-C

surface-mounted light; cast metal, satin nickel / plastic, white  
Aufbauleuchte; Metallguss, nickel-matt / Kunststoff, weiss  
luminaire en saillie; fonte métallique, nickel mat / plastique, blanc

H 40, Ø 225

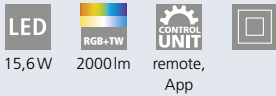

LED 15,6W  
RGB+TW 2000lm  
CONTROL UNIT remote, App

### 96678 FUEVA-C

surface-mounted light; cast metal, satin nickel / plastic, white  
Aufbauleuchte; Metallguss, nickel-matt / Kunststoff, weiss  
luminaire en saillie; fonte métallique, nickel mat / plastique, blanc

H 40, Ø 300

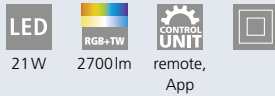

LED 21W  
RGB+TW 2700lm  
CONTROL UNIT remote, App



9 002759 966775

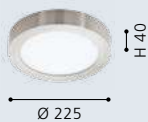

Ø 225



9 002759 966782

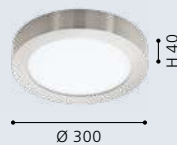

Ø 300



96679



96681



### 96679 FUEVA-C

surface-mounted light; cast metal, satin nickel / plastic, white  
 Aufbauleuchte; Metallguss, nickel-matt / Kunststoff, weiss  
 luminaire en saillie; fonte métallique, nickel mat / plastique, blanc

L 225, B 225, H 40

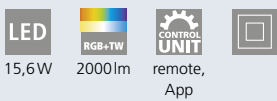

15,6W 2000lm remote, App

### 96681 FUEVA-C

surface-mounted light; cast metal, satin nickel / plastic, white  
 Aufbauleuchte; Metallguss, nickel-matt / Kunststoff, weiss  
 luminaire en saillie; fonte métallique, nickel mat / plastique, blanc

L 300, B 300, H 40

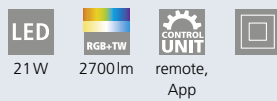

21W 2700lm remote, App



9 002759 966799



9 002759 966812

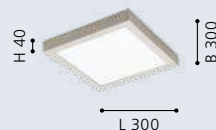





98561



IP44



98559



IP44

### 98559 FUEVA-C

surface-mounted light; cast metal, chrome / plastic, white  
 Aufbauleuchte; Metallguss, chrom / Kunststoff, weiss  
 luminaire en saillie; fonte métallique, chrome / plastique, blanc

H 40, Ø 300

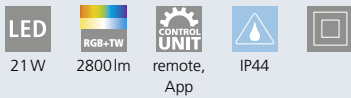

### 98561 FUEVA-C

surface-mounted light; cast metal, chrome / plastic, white  
 Aufbauleuchte; Metallguss, chrom / Kunststoff, weiss  
 luminaire en saillie; fonte métallique, chrome / plastique, blanc

L 300, B 300, H 40

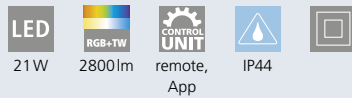

9 002759 985592



9 002759 985615



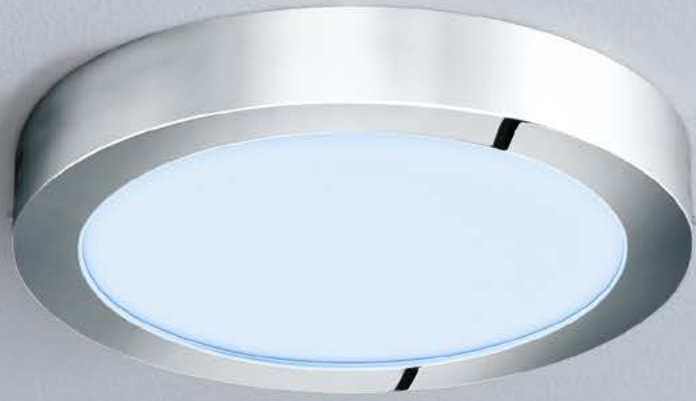

98559



### FUEVA-C

These luminaires are protected against splash water.

Diese Leuchten sind gegen Spritzwasser geschützt.

Les luminaires sont protégées contre les éclaboussures d'eau.

IP44



	0	1	2	3
EU	X	X	✓	✓
FR	X	X	X	✓



32741  
32733



32741, 32733

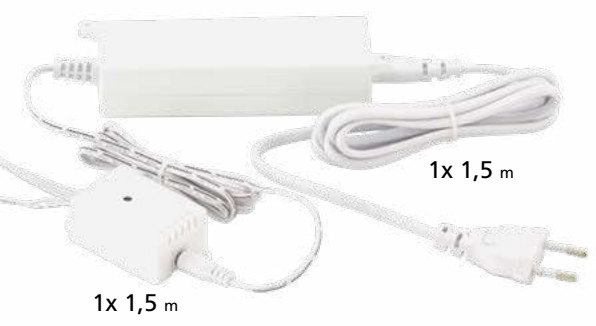

1x 1,5 m

1x 1,5 m



**32741 STRIPE-C**

bar / strip light; plastic, white  
Leuchtband/-stab; Kunststoff, weiss  
bande lumineuse / bâton l; plastique, blanc

L 3000, B 12, H 3

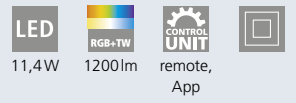

LED 11,4W  
RGB+TW 1200lm  
CONTROL UNIT remote, App

**32733 STRIPE-C**

bar / strip light; plastic, white  
Leuchtband/-stab; Kunststoff, weiss  
bande lumineuse / bâton l; plastique, blanc

L 5000, B 12, H 3

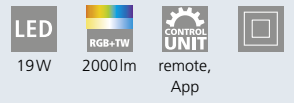

LED 19W  
RGB+TW 2000lm  
CONTROL UNIT remote, App



L 3000



L 5000





# EGLO Access

Let **light** follow  
your **life**



# OVERVIEW



ACCESS REMOTE  
**46**



SARSINA-A  
**46**



SARSINA-A  
**46**



SARSINA-A  
**47**



SALOBRENA-A  
**48**



SALOBRENA-A  
**48**



SALOBRENA-A  
**48**



SALOBRENA-A  
**49**



SALOBRENA-A  
**49**



FUEVA-A  
**51**



FUEVA-A  
**51**



FUEVA-A  
**51**



LED-STRIPE-A  
**52**



LED-STRIPE-A  
**52**



# LET LIGHT FOLLOW YOUR LIFE

DAS LICHT, DAS SICH IHREM LEBEN ANPASST  
LA LUMIÈRE QUE S'ADAPTE À VOTRE VIE



Light influences our lives and our work. For example, bright neutral white light improves focus, while warm, dimmed light makes us feel comfortable. You can adjust your EGLO Access luminaires to your requirements or mood.

- › One remote control for different light scenarios
- › 4-ready made settings
- › Tunable white: individually adjustable from warm white to cold white
- › Dimmable with incl. remote control
- › 2 memory functions for individual light

Licht beeinflusst unser Leben und unsere Tätigkeiten. Zum Beispiel fördert helles, neutralweißes Licht die Konzentration, wohingegen warmes, gedimmtes Licht uns ein Gefühl von Behaglichkeit gibt. Je nach Anforderung oder Stimmung können Sie Ihre EGLO Access Leuchte individuell einstellen.

- › Eine Fernbedienung für verschiedene Lichtszenarien
- › 4 fertige Einstellungen
- › Stimmbares Weiß: individuell einstellbar von Warmweiß bis Kaltweiß
- › Dimmbar mit inkludierter Fernbedienung
- › 2 Speicherfunktionen für individuelles Licht

La lumière influence nos vies et nos activités. Par exemple, une lumière blanche brillante et neutre favorise la concentration, tandis qu'une lumière chaude et atténuée nous procure une sensation de confort. En fonction de vos besoins ou de votre humeur, vous pouvez régler votre éclairage EGLO Access.

- › Une seule télécommande pour différents scénarios d'éclairage
- › 4 réglages prêts à l'emploi
- › Blanc accordable : réglable individuellement du blanc chaud au blanc froid
- › Graduable avec télécommande incluse
- › 2 fonctions mémoire pour un éclairage individuel

## THE SYSTEM'S ADVANTAGES ARE:

## DIE VORTEILE DES SYSTEMS SIND:

## LES AVANTAGES DU SYSTÈME SONT :



Quick and simple installation

Schnelle und einfache Installation

Installation simple et rapide



One remote control for up to 8 different items and a control distance up to 10 meters.

Eine Fernbedienung für bis zu 8 verschiedene Artikel und steuerbar bis zu 10 Meter

Une seule télécommande pour jusqu'à 8 articles différents et contrôlable jusqu'à 10 mètres



Light colour from 2700K to 6500K

Lichtfarbe von 2700K bis 6500K

Couleur de lumière de 2 700 K à 6 500 K



No internet access necessary

Kein Internetzugang erforderlich

Aucun accès internet nécessaire



# FUNCTIONS

## FUNKTIONEN FONCTIONS

Relax with warm light and leave the hustle and bustle of everyday life behind you. Concentrate on your work or dispel fatigue, with neutral white light the energy level is replenished. EGLO Access offers these possibilities and many more. All functions and highlights at a glance:

› It works with radio frequency technology and allows 360 degree control

› Controllable up to a distance of 10 meters

› Up to 8 different items can be connected

› Easy handling thanks to 4 ready-made settings and 2 memory functions

NIGHT LIGHT

RELAX MODE

WORK MODE

SWITCH OFF AFTER 30 MINUTES

Mit warmem Licht entspannen und die Hektik des Alltages hinter sich lassen. Konzentriert arbeiten oder die Müdigkeit vertreiben, mit neutralweißem Licht wird das Energielevel wieder aufgefüllt. Diese Möglichkeiten und noch viele mehr bietet Ihnen EGLO Access. Alle Funktionen und Highlights auf einem Blick:

› Es arbeitet mit Funktechnologie und ermöglicht eine 360-Grad-Steuerung

› Steuerbar bis zu einer Entfernung von 10 Metern

› Bis zu 8 verschiedene Artikel können miteinander verbunden werden

› Einfache Handhabung durch 4 vorgefertigte Einstellungen und 2 Speicherfunktionen

NACHTLICHT

ENTSPANNUNGSMODUS

ARBEITSMODUS

AUSSCHALTEN NACH 30 MINUTEN

Lumière chaude pour se détendre et laisser l'agitation quotidienne derrière soi. Travailler de manière concentrée ou chasser la fatigue, avec une lumière blanche neutre, le niveau d'énergie est rétabli. EGLO Access vous offre ces possibilités et bien d'autres encore. Toutes les fonctions et les points forts en un coup d'œil :

› Il fonctionne avec la technologie de la fréquence radio et permet un contrôle à 360 degrés

› Contrôlable jusqu'à une distance de 10 mètres

› Jusqu'à 8 articles différents peuvent être connectés ensemble

› Manipulation facile grâce à 4 réglages prêts à l'emploi et 2 fonctions mémoire

VEILLEUSE

MODE DE DÉCOMPRESSION

MODE DE TRAVAIL

EXTINCTION APRÈS 30 MINUTES

## COLOUR TEMPERATURES SCALE / FARBTEMPERATUREN SKALA / ÉCHELLE DES TEMPÉRATURES DE COULEUR



# REMOTE CONTROL

FERNBEDIENUNG  
TÉLÉCOMMANDE

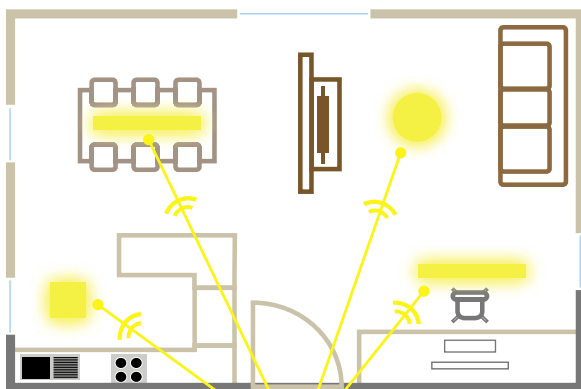

no internet necessary  
kein Internet erforderlich  
nul besoin d'internet



Control up to 8 EGLO Access luminaires  
Bis zu 8 EGLO Access Leuchten steuerbar  
Contrôle jusqu'à 8 luminaires EGLO Access



incl./inkl./inclus

98207



33199



incl./inkl./inclus



incl./inkl./inclus

98208



### 33199 ACCESS REMOTE

remote control; plastic, anthracite  
Fernbedienung; Kunststoff, anthrazit  
Télécommande; plastique, anthracite

L 118, B 45



CR2032



9 002759 331993



B 45

### 98207 SARSINA-A

ceiling light; aluminium, white / plastic, white  
Deckenleuchte; Alu, weiss / Kunststoff, weiss  
plafonnier; aluminium, blanc / plastique, blanc

H 50, Ø 300



14W



2000lm



remote



9 002759 982072



Ø 300

### 98208 SARSINA-A

ceiling light; aluminium, white / plastic, white  
Deckenleuchte; Alu, weiss / Kunststoff, weiss  
plafonnier; aluminium, blanc / plastique, blanc

H 50, Ø 450



19,5W



2750lm



remote



9 002759 982089

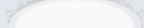

Ø 450



98209

LED



98209

### 98209 SARSINA-A

ceiling light; aluminium, white / plastic, white  
Deckenleuchte; Alu, weiss / Kunststoff, weiss  
plafonnier; aluminium, blanc / plastique, blanc

H 50, Ø 600

LED

30W

tunable  
WHITE

4000lm



CONTROL  
UNIT

remote

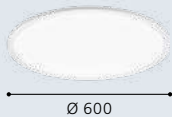





### 98201 SALOBRENA-A

ceiling light; aluminium, white / plastic, white  
 Deckenleuchte; Alu, weiss / Kunststoff, weiss  
 plafonnier; aluminium, blanc / plastique, blanc

L 300, B 300, H 50



### 98297 SALOBRENA-A

ceiling light; aluminium, white / plastic, white  
 Deckenleuchte; Alu, weiss / Kunststoff, weiss  
 plafonnier; aluminium, blanc / plastique, blanc

L 450, B 450, H 50



### 98203 SALOBRENA-A

ceiling light; aluminium, white / plastic, white  
 Deckenleuchte; Alu, weiss / Kunststoff, weiss  
 plafonnier; aluminium, blanc / plastique, blanc

L 600, B 600, H 50





98205

LED



incl./inkl./inclus



98206

LED



incl./inkl./inclus



### 98205 SALOBRENA-A

ceiling light; aluminium, white / plastic, white  
Deckenleuchte; Alu, weiss / Kunststoff, weiss  
plafonnier; aluminium, blanc / plastique, blanc

L 1200, B 300, H 50



### 98206 SALOBRENA-A

ceiling light; aluminium, white / plastic, white  
Deckenleuchte; Alu, weiss / Kunststoff, weiss  
plafonnier; aluminium, blanc / plastique, blanc

L 1195, B 100, H 50



9 002759 982058

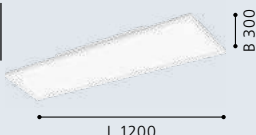

9 002759 982065

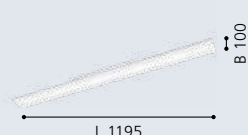



98212

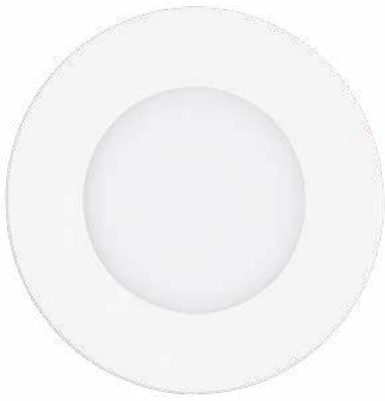

### 98212 FUEVA-A

recessed light; aluminium, white / plastic, white  
Einbauleuchte; Alu, weiss / Kunststoff, weiss  
luminaire encastrable; aluminium, blanc / plastique, blanc

Ø 120, ET 30



9 002759 982126



Ø 120

### 98292 FUEVA-A

surface-mounted light; aluminium, white / plastic, white  
Aufbauleuchte; Alu, weiss / Kunststoff, weiss  
luminaire en saillie; aluminium, blanc / plastique, blanc

H 30, Ø 225



9 002759 982928



Ø 225

### 98293 FUEVA-A

surface-mounted light; aluminium, white / plastic, white  
Aufbauleuchte; Alu, weiss / Kunststoff, weiss  
luminaire en saillie; aluminium, blanc / plastique, blanc

H 30, Ø 300



9 002759 982935



Ø 300



98295

98296



98295, 98296

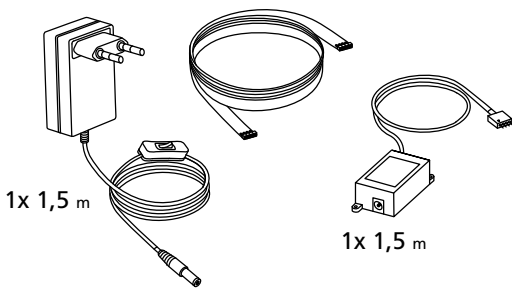

98295, 98296

These articles include a remote control.

Bei diesen Artikeln ist eine Fernbedienung inkludiert.

Ces articles comprennent une télécommande.



98295 LED-STRIPE-A

bar / strip light; plastic, white  
Leuchtband/-stab; Kunststoff, weiss  
bande lumineuse / bâton l; plastique, blanc

L 2000, B 10, H 3



98296 LED-STRIPE-A

bar / strip light; plastic, white  
Leuchtband/-stab; Kunststoff, weiss  
bande lumineuse / bâton l; plastique, blanc

L 5000, B 10, H 3

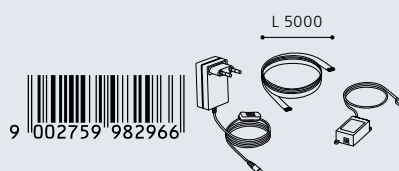
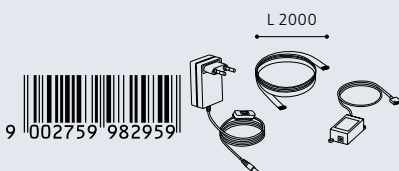



98296



# RECESSED & SURFACE LUMINAIRES

## EMPHASIZE THE FEATURES

EMPHASIZE THE FEATURES - DISCREET IN THE APPEARANCE, PERFECTION IN STAGING. INSTEAD OF PUTTING THEMSELVES IN SCENE, THE RECESSED & SURFACE MOUNTED LUMINAIRES ARE HIGHLIGHTING YOUR LIVING AREA. THEY CONVINCE WITH THEIR UNCOMPLICATED APPLICATION AND DUE TO THE USE OF LED-PLATES AND LED-ILLUMINANTS THEY ARE POWER- AND COST-SAVING.

---

## VORTEILE

DEZENT IM AUFTRETEN, PERFEKT IN DER INSZENIERUNG. UNSERE EIN- UND AUFBAULEUCHTEN SETZEN NICHT SICH SELBST, SONDERN IHR ZUHAUSE IN SZENE. SIE ÜBERZEUGEN MIT IHRER UNKOMPLIZIERTEN ANWENDUNG UND SIND AUFGRUND DER LED-PLATINEN UND LED-LEUCHTMITTEL STROM- UND KOSTENSPAREND.

---

## AVANTAGES

DISCRET EN APPARENCE - PARFAIT DANS LA MIS EN SCÈNE. NOS LUMINAIRES ENCASTRÉES ET EN SAILLIE NE METTENT PAS EUX-MÊMES EN SCÈNE, MAIS VOTRE MAISON. ILS IMPRESSIONNENT PAR LEUR APPLICATION SIMPLE. EN PLUS, ILS RÉDUISENT LES COÛTS ET LE BESOIN D'ÉNERGIE GRÂCE AUX PLATINES ET LAMPES À LED.

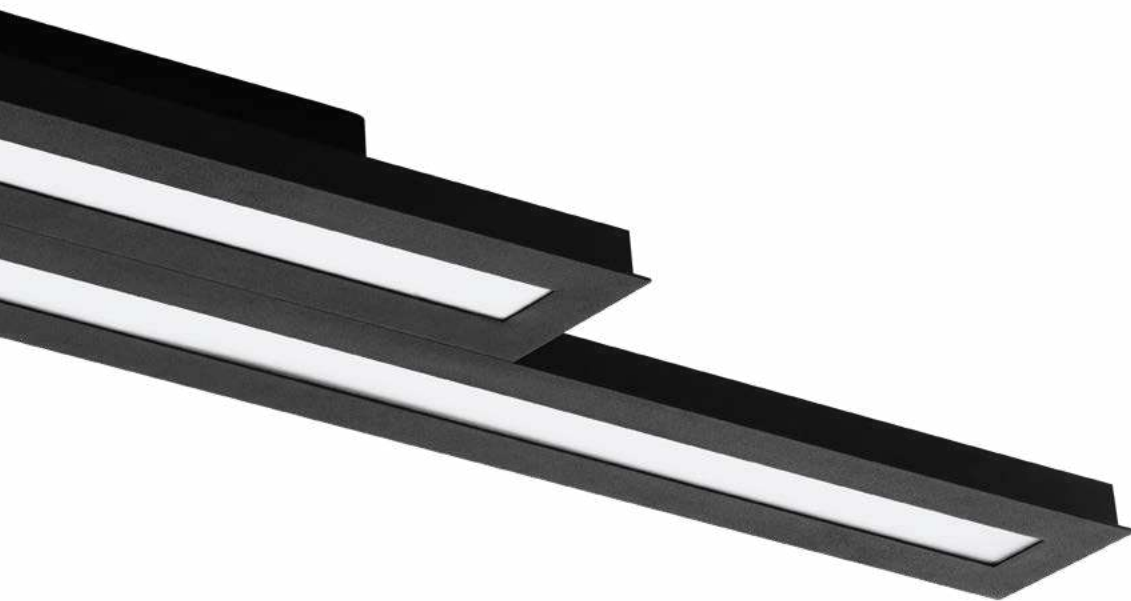

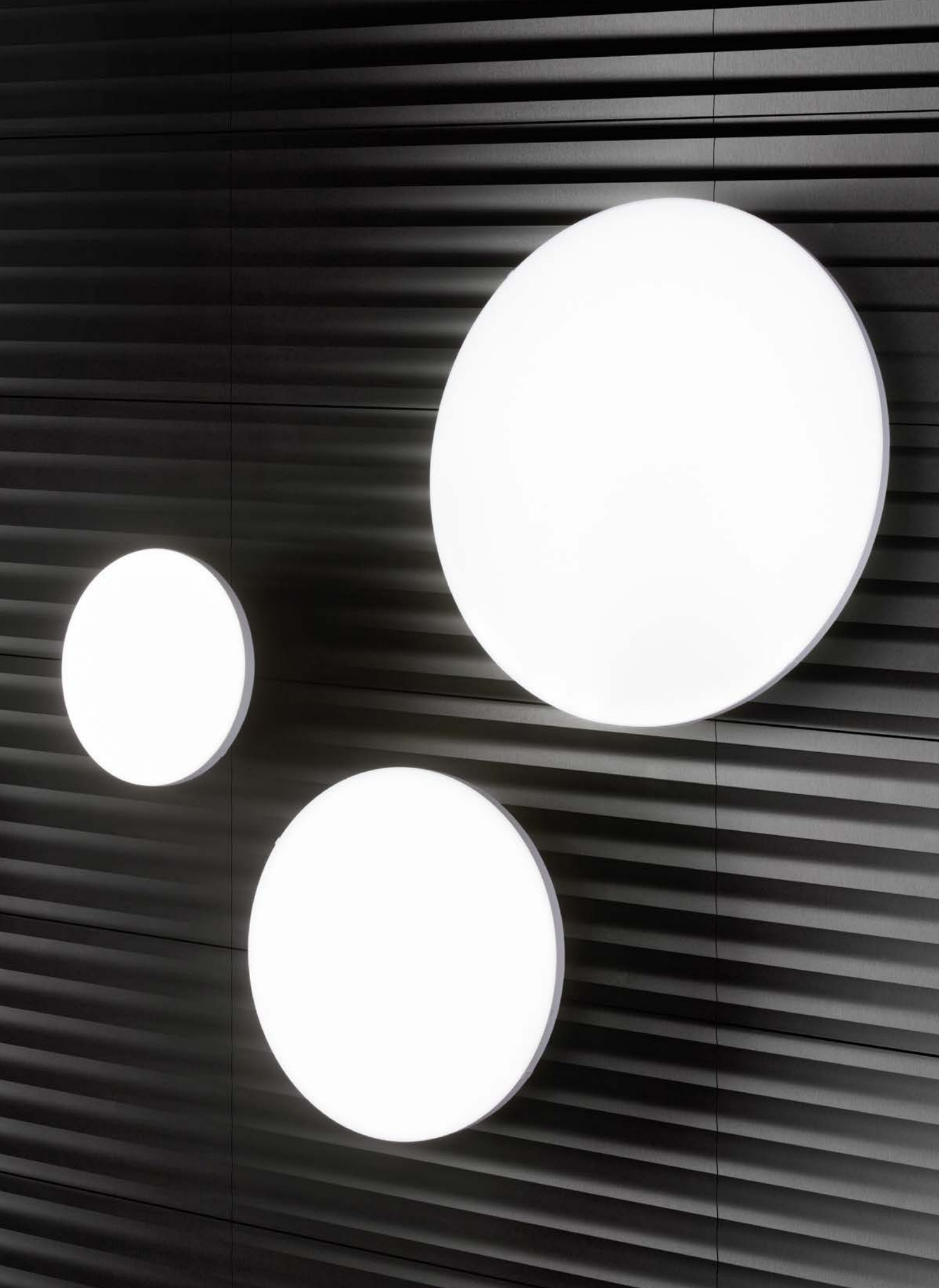





# LED PANEL LUMINAIRES

## DECORATIVE

### ADVANTAGES

- > ULTRA-FLAT DESIGN
  - > HOMOGENEOUS SURFACE LIGHTING
  - > SIMPLE AND FAST INSTALLATION
  - > DECORATIVE DOMESTIC LIGHTING
  - > WALL AND CEILING LIGHTING
- 

### VORTEILE

- > ULTRAFLACHES DESIGN
  - > HOMOGENE LICHTVERTEILUNG
  - > EINFACHE UND SCHNELLE MONTAGE
  - > DEKORATIVE WOHNBELEUCHTUNG
  - > WAND- UND DECKENBELEUCHTUNG
- 

### AVANTAGES

- > DESIGN ULTRA PLAT
  - > ÉCLAIRAGE DE SURFACE HOMOGENÈ
  - > MONTAGE SIMPLE ET RAPIDE
  - > ÉCLAIRAGE DOMESTIQUE DÉCORATIF
  - > ÉCLAIRAGE MURAL ET PLAFONNIER
- 

# OVERVIEW

**5** year warranty  
Jahre Garantie  
ans de garantie  
anni di garanzia  
años de garantía  
anos de garantia



99038  
**58**



99039  
**58**

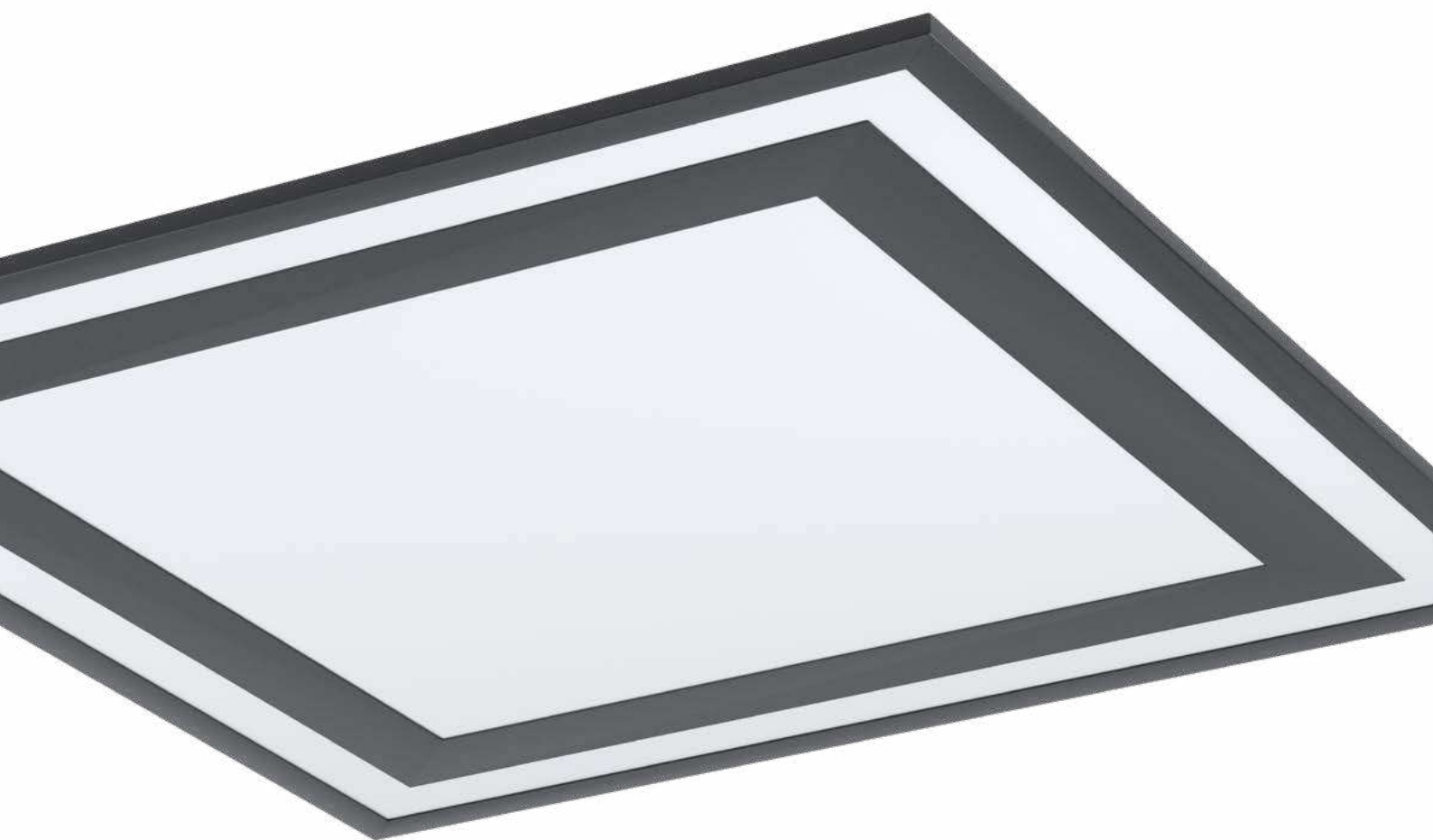



99038

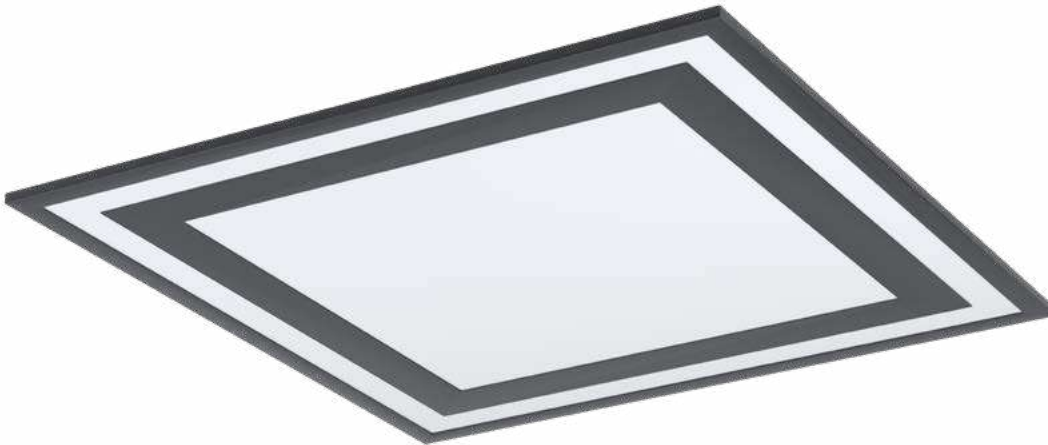

99039



### 99038 SAVATARILA

ceiling light; aluminium, black / plastic, white  
Deckenleuchte; Alu, schwarz / Kunststoff, weiss  
plafonnier; aluminium, noir / plastique, blanc

L 450, B 450, H 60



24W 2900lm

### 99039 SAVATARILA

ceiling light; aluminium, black / plastic, white  
Deckenleuchte; Alu, schwarz / Kunststoff, weiss  
plafonnier; aluminium, noir / plastique, blanc

L 595, B 595, H 60



36W 4600lm



9 002759 990381

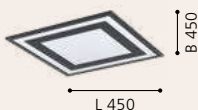

9 002759 990398





99038







# LED PANEL LUMINAIRES

## BASIC

### ADVANTAGES

- > SLIM DESIGN WITH 6 MOUNTING OPTIONS
  - > UNIFORM DISTRIBUTION OF LIGHT - IDEAL FOR ILLUMINATING SPACES AND SURFACES
  - > LOW TEMPERATURE ENHANCES SAFETY
  - > UP TO 80% POWER SAVINGS COMPARED TO INCANDESCENT LAMPS. SAVES YOUR BUDGET AND TAKES CARE OF THE ENVIRONMENT
- 

### VORTEILE

- > SCHLANKE BAUFORM MIT 6 MONTAGEVARIANTEN
  - > HOMOGENE LICHTVERTEILUNG – IDEAL ZUR BELEUCHTUNG VON RÄUMEN UND FLÄCHEN
  - > GERINGE WÄRMEENTWICKLUNG SORGT FÜR MEHR SICHERHEIT
  - > BIS ZU 80% STROMERSPARNIS GEGENÜBER GLÜHLAMPEN, SCHONT IHR BUDGET UND DIE UMWELT
- 

### AVANTAGES

- > CONCEPTION MINCE AVEC 6 OPTIONS DE MONTAGE
- > DISTRIBUTION UNIFORME DE LA LUMIÈRE - IDÉAL POUR L'ILLUMINATION DES ESPACES ET SURFACES
- > FAIBLE CHALEUR AMÉLIORE LA SÉCURITÉ
- > JUSQU'À 80% D'ÉCONOMIES D'ÉNERGIE PAR RAPPORT AUX LAMPES À INCANDESCENCE, RÉDUIT VOTRE BUDGET ET PROTÈGE L'ENVIRONNEMENT

# OVERVIEW

**5** year warranty  
Jahre Garantie  
ans de garantie  
anni di garanzia  
años de garantía  
anos de garantia



96152  
**62**



96153  
**62**



96154  
**62**



96151  
**63**



61489  
**64**



61355  
**64**



61358  
**64**



61359  
**65**



61361  
**65**



## MOUNTING INCLUDED

Montagezubehör inkludiert  
accessoires inclus

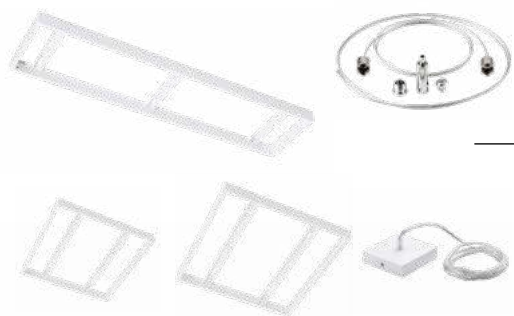

## ACCESSORIES OPTIONAL

page / Seite / page **64-65**

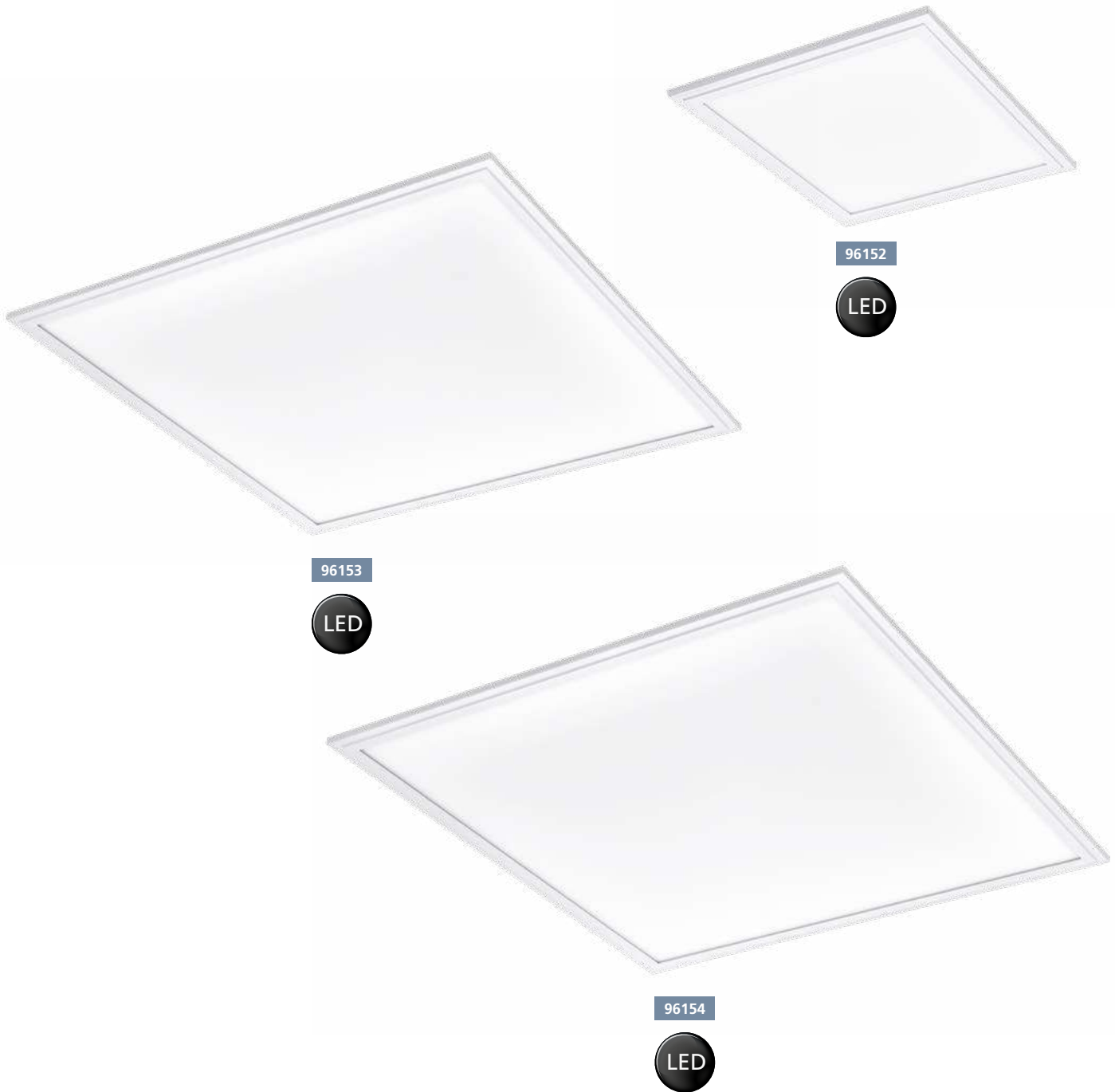

### 96152 SALOBRENA 1

grid light; aluminium, white / plastic, white  
 Rasterleuchte; Alu, weiss / Kunststoff, weiss  
 luminaire à grille; aluminium, blanc / plastique, blanc

L 300, B 300, H 11



16W 2100lm

### 96153 SALOBRENA 1

grid light; aluminium, white / plastic, white  
 Rasterleuchte; Alu, weiss / Kunststoff, weiss  
 luminaire à grille; aluminium, blanc / plastique, blanc

L 595, B 595, H 11



40W 4300lm

### 96154 SALOBRENA 1

grid light; aluminium, white / plastic, white  
 Rasterleuchte; Alu, weiss / Kunststoff, weiss  
 luminaire à grille; aluminium, blanc / plastique, blanc

L 620, B 620, H 11



40W 4100lm



9 002759 961527



9 002759 961534



9 002759 961541

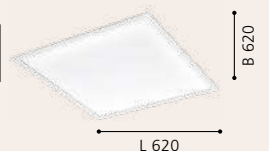



96151

LED

## MOUNTING WITH INCLUDED MATERIAL

MONTAGE MIT INKLUDIERTEM MONTAGEMATERIAL

MONTAGE AVEC MATÉRIEL DE MONTAGE INCLUS



**1** GRID LUMINAIRE  
RASTERLEUCHTE  
LUMINAIRE À GRILLE

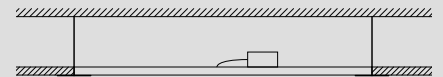

**2** RECESSED LUMINAIRE  
EINBAULEUCHTE  
LUMINAIRE ENCASTRÉE



### 96151 SALOBRENA 1

grid light; aluminium, white / plastic, white  
Rasterleuchte; Alu, weiss / Kunststoff, weiss  
luminaire à grille; aluminium, blanc / plastique, blanc

L 1200, B 300, H 11



40W 5500lm



9 002759 961510



**3** SEMI-RECESSED LUMINAIRE  
SEMI-EINBAULEUCHTE  
LUMINAIRE SEMI-ENCASTRÉE



**4** SURFACE LUMINAIRE  
AUFBAULEUCHTE  
LUMINAIRE EN SAILLIE

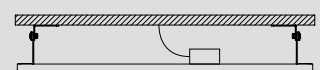





### 61489 SALOBRENA 1

accessory; steel, white  
Zubehör; Stahl, weiss  
accessoire; acier, blanc

L 95, B 95, H 2000

### 61355 SALOBRENA 1

accessory; steel, chrome  
Zubehör; Stahl, chrom  
accessoire; acier, chrome

L 900

### 61358 SALOBRENA 1

accessory; steel, white  
Zubehör; Stahl, weiss  
accessoire; acier, blanc

L 603, B 603, H 50





61361



61359

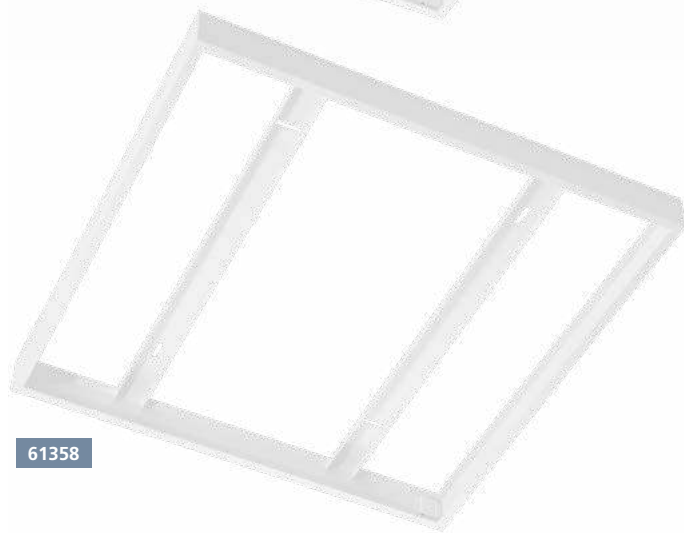

61358

## OPTIONAL MOUNTING

OPTIONALE MONTAGE  
MONTAGE OPTIONNEL



### 5 PENDANT LUMINAIRE HÄNGELEUCHE LUMINAIRE SUSPENSION

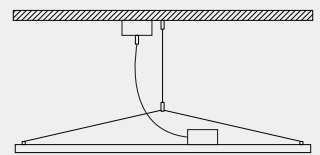

### 61359 SALOBRENA 1

accessory; steel, white  
Zubehör; Stahl, weiss  
accessoire; acier, blanc

L 627, B 628, H 50

### 61361 SALOBRENA 1

accessory; steel, white  
Zubehör; Stahl, weiss  
accessoire; acier, blanc

L 303, B 1205, H 50



### 6 FRAME SURFACE LUMINAIRE RAHMEN AUFBAULEUCHE LUMINAIRE EN SAILLIE AVEC BOX

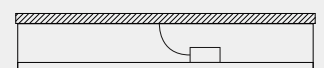

9 002759 613594

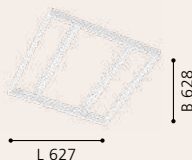

9 002759 613617

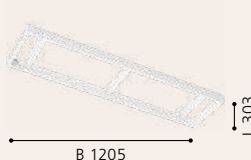



# LED PANEL LUMINAIRES

## FRAMELESS

### ADVANTAGES

- > THE ENTIRE BODY OF THE PANEL IS UTILIZED AS LIGHT SOURCE
  - > ULTRA-FLAT DESIGN
  - > HOMOGENEOUS SURFACE LIGHTING
  - > SIMPLE AND FAST INSTALLATION
  - > ELEGANT SUSPENSION FRAME INCLUDED
  - > DECORATIVE DOMESTIC LIGHTING
  - > WALL AND CEILING LIGHTING
- 

### VORTEILE

- > DER GESAMTE LEUCHTKÖRPER DIENT ALS LEUCHTFLÄCHE
  - > ULTRAFLACHES DESIGN
  - > HOMOGENE LICHTVERTEILUNG
  - > EINFACHE UND SCHNELLE MONTAGE
  - > INKL. ELEGANTEM SCHWEBERAHMEN
  - > DEKORATIVE WOHNBELEUCHTUNG
  - > WAND- UND DECKENBELEUCHTUNG
- 

### AVANTAGES

- > LE CORPS ENTIER DU PANNEAU EST UTILISÉ COMME SOURCE DE LUMIÈRE
  - > DESIGN ULTRA PLAT
  - > ÉCLAIRAGE DE SURFACE HOMOGÈNE
  - > MONTAGE SIMPLE ET RAPIDE
  - > BÂTI FLOTTANT ÉLÉGAN INCLUS
  - > ÉCLAIRAGE DOMESTIQUE DÉCORATIF
  - > ÉCLAIRAGE MURAL ET PLAFONNIER
- 

# OVERVIEW

**5** year warranty  
Jahre Garantie  
ans de garantie  
anni di garanzia  
años de garantía  
anos de garantia

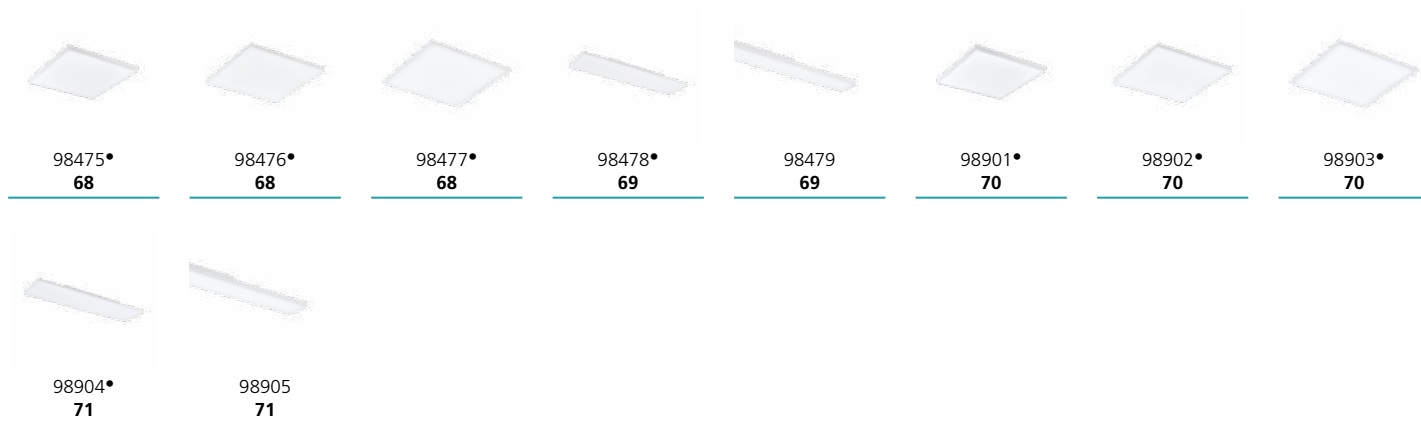

## ACCESSORIES INCLUDED•

Suspension frame for  
Schweberahmen für  
Bâti flottant pour





98475



98476



98477



### 98475 TURCONA

ceiling light; steel, white / plastic, satined  
Deckenleuchte; Stahl, weiss / Kunststoff, satiniert  
plafonnier; acier, blanc / plastique, satiné

L 300, B 300, H 60



11 W 1300lm

### 98476 TURCONA

ceiling light; steel, white / plastic, satined  
Deckenleuchte; Stahl, weiss / Kunststoff, satiniert  
plafonnier; acier, blanc / plastique, satiné

L 450, B 450, H 60



20 W 2400lm

### 98477 TURCONA

ceiling light; steel, white / plastic, satined  
Deckenleuchte; Stahl, weiss / Kunststoff, satiniert  
plafonnier; acier, blanc / plastique, satiné

L 595, B 595, H 60



33 W 3800lm



9 002759 984755



9 002759 984762

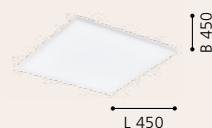

9 002759 984779

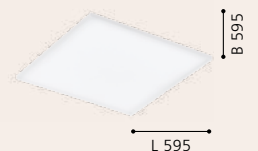



98479



98478



### 98478 TURCONA

ceiling light; steel, white / plastic, satined  
 Deckenleuchte; Stahl, weiss / Kunststoff, satiniert  
 plafonnier; acier, blanc / plastique, satiné

L 1200, B 300, H 60



33W 3800lm

### 98479 TURCONA

ceiling light; steel, white / plastic, satined  
 Deckenleuchte; Stahl, weiss / Kunststoff, satiniert  
 plafonnier; acier, blanc / plastique, satiné

L 1200, B 100, H 60



20W 2600lm





98901



98902



98903



### 98901 TURCONA

ceiling light; steel, white / plastic, satined  
Deckenleuchte; Stahl, weiss / Kunststoff, satiniert  
plafonnier; acier, blanc / plastique, satiné

L 300, B 300, H 60



11 W 1400lm

### 98902 TURCONA

ceiling light; steel, white / plastic, satined  
Deckenleuchte; Stahl, weiss / Kunststoff, satiniert  
plafonnier; acier, blanc / plastique, satiné

L 450, B 450, H 60



20 W 2600lm

### 98903 TURCONA

ceiling light; steel, white / plastic, satined  
Deckenleuchte; Stahl, weiss / Kunststoff, satiniert  
plafonnier; acier, blanc / plastique, satiné

L 595, B 595, H 60



33 W 4200lm



9 002759 989019

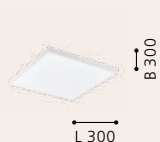

9 002759 989026

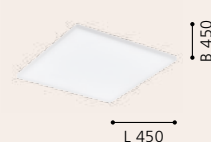

9 002759 989033

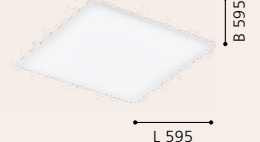



98905



98904



### 98904 TURCONA

ceiling light; steel, white / plastic, satined  
Deckenleuchte; Stahl, weiss / Kunststoff, satiniert  
plafonnier; acier, blanc / plastique, satiné

L 1200, B 300, H 60



33W 4200lm

### 98905 TURCONA

ceiling light; steel, white / plastic, satined  
Deckenleuchte; Stahl, weiss / Kunststoff, satiniert  
plafonnier; acier, blanc / plastique, satiné

L 1200, B 100, H 60



20W 2900lm



9 002759 989040

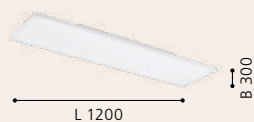

9 002759 989057

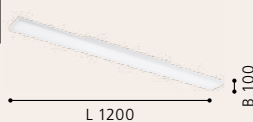



# LED PANEL LUMINAIRES

## WITH SUSPENSION FRAME

### ADVANTAGES

- > SURFACE LIGHT WITH SHADOWLESS LIGHTING
  - > ULTRA-FLAT DESIGN
  - > HOMOGENEOUS SURFACE LIGHTING
  - > SIMPLE INSTALLATION
  - > ELEGANT SUSPENSION FRAME INCLUDED
  - > ALSO FOR FLUSH MOUNTING SUITABLE
- 

### VORTEILE

- > FLÄCHIGES LICHT MIT SCHATTENFREIER AUSLEUCHTUNG
  - > ULTRAFLACHES DESIGN
  - > HOMOGENE FLÄCHENAUSLEUCHTUNG
  - > EINFACHE MONTAGE
  - > INKL. ELEGANTEM SCHWEBERAHMEN
  - > AUCH FÜR FLÄCHENBÜNDIGEN EINBAU GEEIGNET
- 

### AVANTAGES

- > ÉCLAIRAGE ÉTALÉ AVEC ÉCLAIREMENT
- > SANS OMBRE
- > DESIGN ULTRA PLAT
- > ÉCLAIRAGE DE SURFACE HOMOGENÈ
- > MONTAGE SIMPLE
- > BÂTI FLOTTANT ÉLÉGANT INCLUS ADAPTÉ AU MONTAGE ENCASTRÉ



# OVERVIEW

**5** year warranty  
Jahre Garantie  
ans de garantie  
anni di garanzia  
años de garantía  
anos de garantia



## ACCESSORIES INCLUDED

Suspension frame for  
Schweberahmen für  
Bâti flottant pour

## MOUNTING INCLUDED\*

Montagezubehör inkludiert  
accessoires inclus



98129



32812



32813



### 32812 SALOBRENA 1

ceiling light; aluminium, steel, white / plastic, white  
Deckenleuchte; Alu, Stahl, weiss / Kunststoff, weiss  
plafonnier; aluminium, acier, blanc / plastique, blanc

L 300, B 300, H 50



16W 2100lm

### 98129 SALOBRENA 1

ceiling light; aluminium, white / plastic, white  
Deckenleuchte; Alu, weiss / Kunststoff, weiss  
plafonnier; aluminium, blanc / plastique, blanc

L 450, B 450, H 50



21W 2700lm

### 32813 SALOBRENA 1

ceiling light; aluminium, steel, white / plastic, white  
Deckenleuchte; Alu, Stahl, weiss / Kunststoff, weiss  
plafonnier; aluminium, acier, blanc / plastique, blanc

L 595, B 595, H 50



40W 4300lm



9 002759 328122



9 002759 981297



9 002759 328139





32811

LED

98025

LED



32812

### 32811 SALOBRENA 1

ceiling light; aluminium, steel, white / plastic, white  
 Deckenleuchte; Alu, Stahl, weiss / Kunststoff, weiss  
 plafonnier; aluminium, acier, blanc / plastique, blanc

L 1200, B 300, H 50



### 98025 SALOBRENA 1

ceiling light; aluminium, white / plastic, white  
 Deckenleuchte; Alu, weiss / Kunststoff, weiss  
 plafonnier; aluminium, blanc / plastique, blanc

L 1195, B 100, H 45

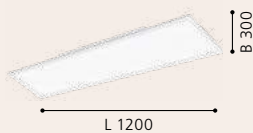



98419



12 m  
5 sec. - 15 min.



98418



12 m  
5 sec. - 15 min.

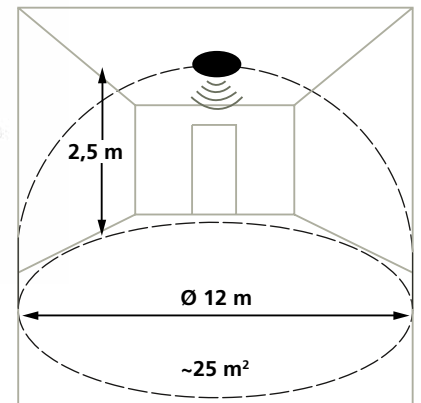

time: 5 sec. - 15 min.

### 98418 SALOBRENA-M

ceiling light; aluminium, white / plastic, white  
Deckenleuchte; Alu, weiss / Kunststoff, weiss  
plafonnier; aluminium, blanc / plastique, blanc

L 595, B 595, H 50



34W 4600lm

### 98419 SALOBRENA-M

ceiling light; aluminium, white / plastic, white  
Deckenleuchte; Alu, weiss / Kunststoff, weiss  
plafonnier; aluminium, blanc / plastique, blanc

L 1195, B 295, H 50



33W 5400lm

### SALOBRENA-M

These luminaires come with an integrated motion sensor. This sensor is mounted invisibly.

Diese Leuchten sind mit einem integrierten Bewegungssensor ausgestattet. Der Sensor ist unsichtbar versteckt.

Ces luminaires viennent avec un capteur de mouvement intégré. Ce capteur est attaché invisiblement.



9 002759 984182



9 002759 984199

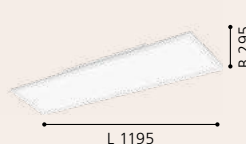



3

2

1





# LED PANEL LUMINAIRES

## DIMMABLE

### ADVANTAGES

- > DIMMABLE
  - > UNIFORM DISTRIBUTION OF LIGHT - IDEAL FOR ILLUMINATING SPACES AND SURFACES
  - > LOW TEMPERATURE ENHANCES SAFETY
  - > UP TO 80% POWER SAVINGS COMPARED TO INCANDESCENT LAMPS. SAVES YOUR BUDGET AND TAKES CARE OF THE ENVIRONMENT
  - > ELEGANT SUSPENSION FRAME INCLUDED
- 

### VORTEILE

- > DIMMBAR
  - > HOMOGENE LICHTVERTEILUNG - IDEAL ZUR BELEUCHTUNG VON RÄUMEN UND FLÄCHEN
  - > GERINGE WÄRMEENTWICKLUNG SORGT FÜR MEHR SICHERHEIT
  - > BIS ZU 80% STROMERSPARNIS GEGENÜBER GLÜHLAMPEN, SCHONT IHR BUDGET UND DIE UMWELT
  - > INKL. ELEGANTEM SCHWEBERAHMEN
- 

### AVANTAGES

- > GRADUABLE
- > DISTRIBUTION UNIFORME DE LA LUMIÈRE - IDÉAL POUR L'ILLUMINATION DES ESPACES ET SURFACES
- > FAIBLE CHALEUR AMÉLIORE LA SÉCURITÉ
- > JUSQU'À 80% D'ÉCONOMIES D'ÉNERGIE PAR RAPPORT AUX LAMPES À INCANDESCENCE, RÉDUIT VOTRE BUDGET ET PROTÈGE L'ENVIRONNEMENT
- > BÂTI FLOTTANT ÉLÉGANT INCLUS

# OVERVIEW

**5** year warranty  
 Jahre Garantie  
 ans de garantie  
 anni di garanzia  
 años de garantía  
 anos de garantia



97501 white  
98213 silver

97502 white  
98214 silver

97503 white  
98215 silver

98485 white

96891 white  
98036 silver

96892 white  
98037 silver

96894 white  
98039 silver

96893 white  
98038 silver

## ACCESSORIES INCLUDED

Suspension frame for  
 Schweberrahmen für  
 Bâti flottant pour

## ACCESSORIES OPTIONAL\*

page / Seite / page **64-65**



## MOUNTING INCLUDED\*

Montagezubehör inkludiert  
 accessoires inclus



97501

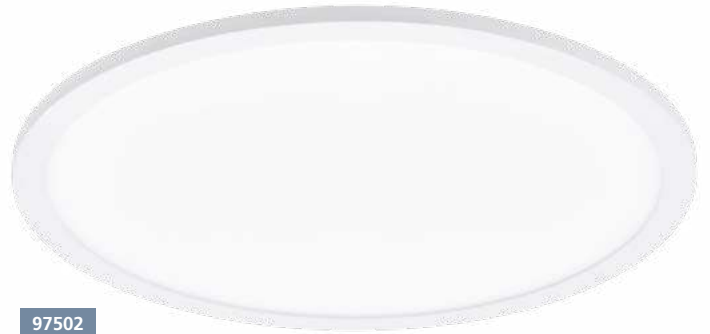

97502



97503



### 97501 SARSINA

ceiling light; aluminium, white / plastic, white  
Deckenleuchte; Alu, weiss / Kunststoff, weiss  
plafonnier; aluminium, blanc / plastique, blanc

H 50, Ø 300



17W 2200lm

### 97502 SARSINA

ceiling light; aluminium, white / plastic, white  
Deckenleuchte; Alu, weiss / Kunststoff, weiss  
plafonnier; aluminium, blanc / plastique, blanc

H 50, Ø 450



28W 4200lm

### 97503 SARSINA

ceiling light; aluminium, white / plastic, white  
Deckenleuchte; Alu, weiss / Kunststoff, weiss  
plafonnier; aluminium, blanc / plastique, blanc

H 50, Ø 600



36W 5500lm



9 002759 975012

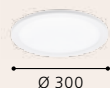

Ø 300



9 002759 975029



Ø 450



9 002759 975036



Ø 600

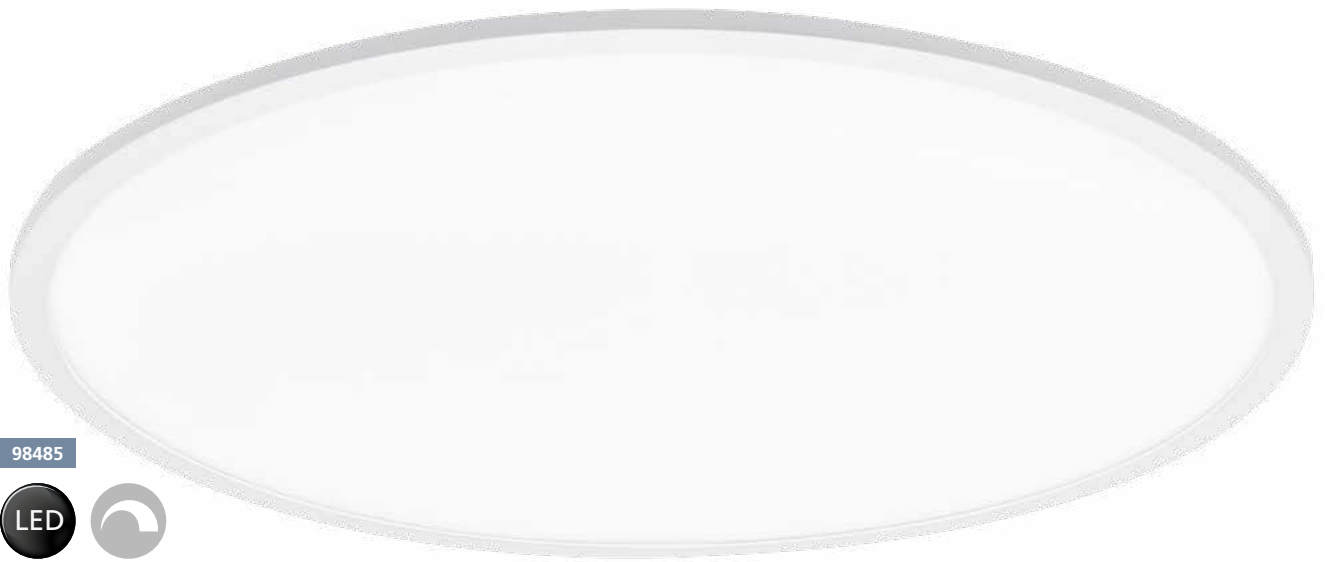

98485



98485

### 98485 SARSINA

ceiling light; aluminium, white / plastic, white  
Deckenleuchte; Alu, weiss / Kunststoff, weiss  
plafonnier; aluminium, blanc / plastique, blanc

H 50, Ø 800



35W 5900lm



9 002759 984854

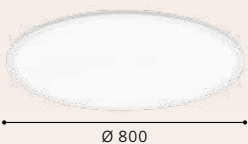



97504



97505



### 97504 SARSINA

pendant light; aluminium, white / plastic, white  
 Hängeleuchte; Alu, weiss / Kunststoff, weiss  
 luminaire en suspension; aluminium, blanc / plastique, blanc

H 1500, Ø 450



28W 4200lm



9 002759 975043

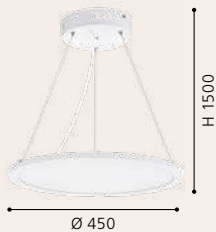

### 97505 SARSINA

pendant light; aluminium, white / plastic, white  
 Hängeleuchte; Alu, weiss / Kunststoff, weiss  
 luminaire en suspension; aluminium, blanc / plastique, blanc

H 1500, Ø 600



36W 5500lm



9 002759 975050

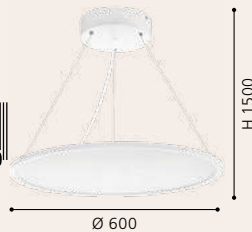



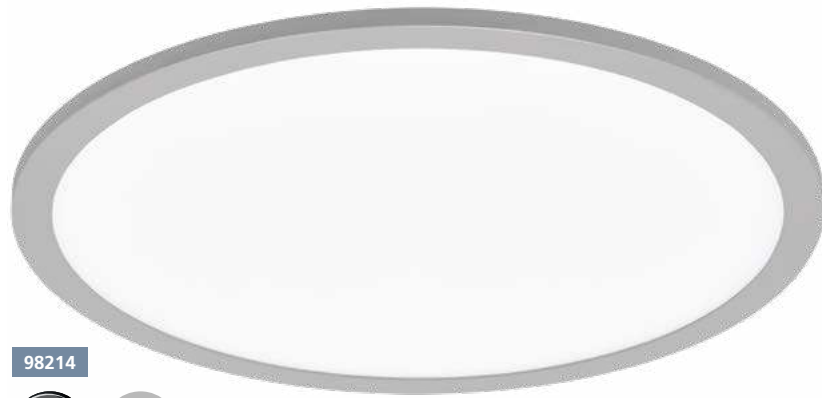

98214

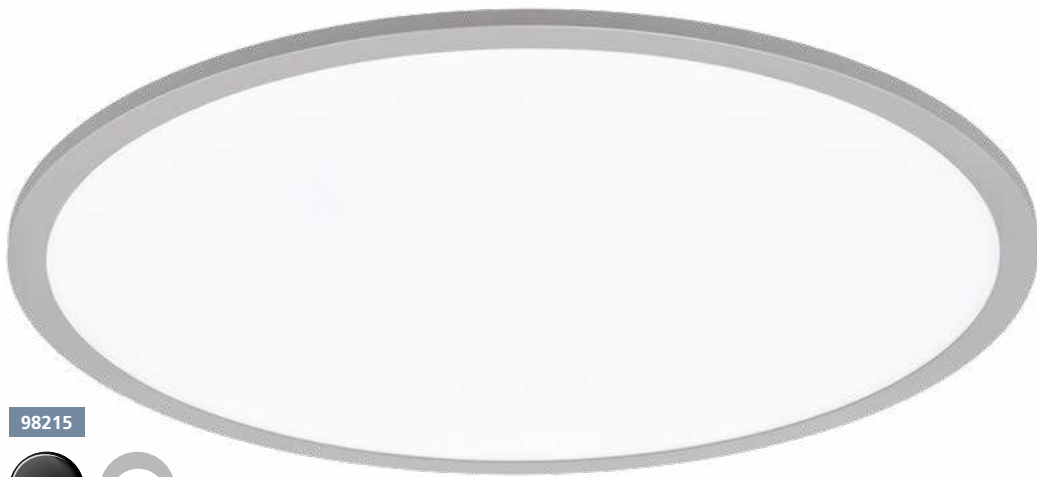

98215



### 98214 SARSINA

ceiling light; aluminium, grey aluminium / plastic, white  
Deckenleuchte; Alu, graualuminium / Kunststoff, weiss  
plafonnier; aluminium, gris aluminium / plastique, blanc

H 50, Ø 450

LED

28W

neutral  
WHITE

4200lm



### 98215 SARSINA

ceiling light; aluminium, grey aluminium / plastic, white  
Deckenleuchte; Alu, graualuminium / Kunststoff, weiss  
plafonnier; aluminium, gris aluminium / plastique, blanc

H 50, Ø 600

LED

36W

neutral  
WHITE

5500lm



9 002759 982140



Ø 450



9 002759 982157



Ø 600



96891



96892



96893



### 96891 SALOBRENA 2

ceiling light; aluminium, white / plastic, white  
Deckenleuchte; Alu, weiss / Kunststoff, weiss  
plafonnier; aluminium, blanc / plastique, blanc

L 300, B 300, H 50



16W 2100lm

### 96892 SALOBRENA 2

ceiling light; aluminium, white / plastic, white  
Deckenleuchte; Alu, weiss / Kunststoff, weiss  
plafonnier; aluminium, blanc / plastique, blanc

L 450, B 450, H 50



25W 3000lm

### 96893 SALOBRENA 2

ceiling light; aluminium, white / plastic, white  
Deckenleuchte; Alu, weiss / Kunststoff, weiss  
plafonnier; aluminium, blanc / plastique, blanc

L 595, B 595, H 50



34W 4200lm



9 002759 968915

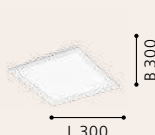

9 002759 968922



9 002759 968939





98026



LED

### 98026 SALOBRENA 2

ceiling light; aluminium, white / plastic, white  
Deckenleuchte; Alu, weiss / Kunststoff, weiss  
plafonnier; aluminium, blanc / plastique, blanc

L 1195, B 100, H 45



31 W 4200 lm



9 002759 980269



L 1195

B 100



96894



LED

### 96894 SALOBRENA 2

ceiling light; aluminium, white / plastic, white  
Deckenleuchte; Alu, weiss / Kunststoff, weiss  
plafonnier; aluminium, blanc / plastique, blanc

L 1200, B 300, H 50



32 W 5200 lm



9 002759 968946



L 1200

B 300



98036



98037



98038



### 98036 SALOBRENA 2

ceiling light; aluminium, grey aluminium / plastic, white  
Deckenleuchte; Alu, graualuminium / Kunststoff, weiss  
plafonnier; aluminium, gris aluminium / plastique, blanc

L 300, B 300, H 50



16W 2100lm

### 98037 SALOBRENA 2

ceiling light; aluminium, grey aluminium / plastic, white  
Deckenleuchte; Alu, graualuminium / Kunststoff, weiss  
plafonnier; aluminium, gris aluminium / plastique, blanc

L 450, B 450, H 50



25W 3000lm

### 98038 SALOBRENA 2

ceiling light; aluminium, grey aluminium / plastic, white  
Deckenleuchte; Alu, graualuminium / Kunststoff, weiss  
plafonnier; aluminium, gris aluminium / plastique, blanc

L 595, B 595, H 50



34W 4200lm



9 002759 980368

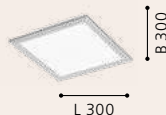

9 002759 980375

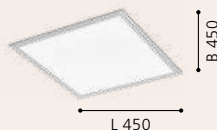

9 002759 980382

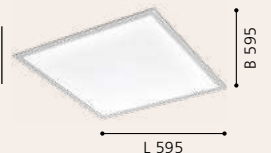



98039



98038

### 98039 SALOBRENA 2

ceiling light; aluminium, grey aluminium / plastic, white  
Deckenleuchte; Alu, graualuminium / Kunststoff, weiss  
plafonnier; aluminium, gris aluminium / plastique, blanc

L 1200, B 300, H 50

LED

32W

neutral  
WHITE

5200lm

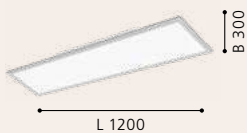





33107



33108



### 33107 SALOBRENA-RGBW

grid light; aluminium, white / plastic, white  
 Rasterleuchte; Alu, weiss / Kunststoff, weiss  
 luminaire à grille; aluminium, blanc / plastique, blanc

L 450, B 450, H 11



21 W 2400lm

### 33108 SALOBRENA-RGBW

grid light; aluminium, white / plastic, white  
 Rasterleuchte; Alu, weiss / Kunststoff, weiss  
 luminaire à grille; aluminium, blanc / plastique, blanc

L 600, B 300, H 11



21 W 2400lm

### SALOBRENA-RGBW

With the remote control (included in delivery) the following features can be adjusted:

Durch die Fernbedienung (im Lieferumfang enthalten) verfügen diese Leuchten über folgende Funktionen:

Les fonctions différentes peuvent être réglées avec une télécommande incluse avec le luminaire:

- > Color change
- > Change to white light
- > Change to RGB
- > Flash (fast color change)
- > Smooth dimming (slow color change)  
10%, 25%, 50%, 100%
- > on/off



9 002759 331078



9 002759 331085

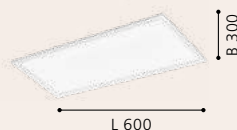



33107





# RECESSED LUMINAIRES

## HIGH VOLTAGE

### ADVANTAGES

- > LOW MOUNTING DEPTH
- > NO TRANSFORMER NECESSARY - THE LATEST LED HIGH-VOLTAGE TECHNOLOGY
- > IDEAL FOR LIGHTING OF ROOMS AND AREAS
- > PLEASANT WARM WHITE LIGHT COLOR
- > LOW TEMPERATURE ENHANCES SAFETY
- > UP TO 80% POWER SAVINGS COMPARED TO INCANDESCENT LAMPS, EASY ON YOUR BUDGET AND THE ENVIRONMENT
- > EASY AND SIMPLE WIRING BY 2-FOLD JUNCTION BOX - EASILY EXPANDABLE

### VORTEILE























































- > GERINGE EINBAUTIEFE
- > KEIN TRAFU MEHR NOTWENDIG - NEUESTE LED HOCHVOLT TECHNOLOGIE
- > IDEAL ZUR BELEUCHTUNG VON RÄUMEN UND FLÄCHEN
- > ANGENEHME WARM-WEISSE LICHTFARBE
- > GERINGE WÄRMEENTWICKLUNG SORGT FÜR MEHR SICHERHEIT
- > BIS ZU 80% STROMERSPARNIS GEGENÜBER GLÜHLAMPEN, SCHONT IHR BUDGET UND DIE UMWELT
- > EINFACHE UND SICHERE VERKABELUNG DURCH 2-FACH ANSCHLUSSBOX - UNKOMPLIZIERT ERWEITERBAR

### ADVANTAGES

- > FAIBLE PROFONDEUR DE MONTAGE
- > AUCUN TRANSFORMATEUR NÉCESSAIRE - LA DERNIÈRE TECHNOLOGIE À HAUTE TENSION LED
- > IDÉAL POUR L'ÉCLAIRAGE DES CHAMBRES ET DES ESPACES
- > AGRÉABLE COULEUR DE LUMIÈRE BLANCHE CHAUDE
- > FAIBLE CHALEUR AMÉLIORE LA SÉCURITÉ
- > JUSQU'À 80% D'ÉCONOMIES D'ÉNERGIE PAR RAPPORT AUX LAMPES À INCANDESCENCE, RÉDUIT VOTRE BUDGET ET PROTÈGE L'ENVIRONNEMENT
- > NOTRE BOITE DE DEUX JONCTIONS PERMET UN CÂBLAGE SIMPLE ET SECURE. EN PLUS ELLE EST FACILEMENT EXTENSIBLE.

# OVERVIEW

**5** year warranty  
 Jahre Garantie  
 ans de garantie  
 anni di garanzia  
 años de garantía  
 anos de garantia

							
PINEDA 94	PINEDA 94	PINEDA 94	PINEDA 95	PINEDA 95	PINEDA 95	PINEDA 96	PINEDA 96
							
PINEDA 97	PINEDA 97	SARTIANO 98	PINEDA 100	PINEDA 100	PINEDA 100	PINEDA 101	PINEDA 101
							
PINEDA 101	SALICETO 102	SALICETO 102	SALICETO 102	SALICETO 103	SALICETO 103	SALICETO 104	SALICETO 104
							
SALICETO 104	SALICETO 105	SALICETO 106	SALICETO 106	SALICETO 106	SALICETO 107	SALICETO 107	SALICETO 108
							
SALICETO 108	SALICETO 108	SALICETO 109	SALICETO 109	SALABATE 110	SALABATE 110	SALABATE 110	SALABATE 111
							
PINEDA 112	PINEDA 112	PINEDA 112	PINEDA 113	PINEDA 113	PINEDA 113	PINEDA 114	PINEDA 114
							
PINEDA 114	PINEDA 1 116	PINEDA 1 116	PINEDA 1 116	PINEDA 1 117	ZARATE 118	ZARATE 118	



# 1 SIMPLE INSTALLATION!

Einfache Montage! / Montage simple !

Universally usable in walls or ceilings thanks to its small installation depth!

Durch die geringe Einbautiefe universell einsetzbar, ob Wand oder Decke!

Emploi universel dû à la faible profondeur de montage, que ce soit au mur ou au plafond !

# 2 QUICK AND SAFE CONNECTION

Schnelles und sicheres Anschließen! /  
Branchement rapide et sûr !

Easy wiring with the practical connection box!  
No transformer is needed anymore thanks to  
state of-the-art high-voltage technology!

Leichtes Verkabeln durch die praktische An-  
schlussbox! Durch moderne Hochvolt-Technik  
wird kein Trafo mehr benötigt!

Câbler simplement avec le boîtier de  
branchement pratique ! Grâce à la technique de  
haute tension moderne, plus besoin de transfor-  
mateur !



# 3 PERFECT FIT!

Perfekter Halt! / Maintien parfait !

The integrated holding brackets permit simple  
installation and guarantee for a precise fit!

Die integrierten Halteklammern ermöglichen  
einen einfachen Einbau und sorgen für garantierte  
Passgenauigkeit!

Les griffes de maintien intégrées permettent un  
montage simple et assurent un parfait ajustement !





# 4

## FLUSH INSTALLATION!

FLÄCHENBÜNDIGER EINBAU! / MONTAGE À FLEUR !

The slim build permits fitting installation in any surface!

Die schlanke Bauform ermöglicht den passenden Einbau bei jeder Fläche!

La structure fine permet le montage adéquat avec chaque surface !





95847

LED



95849

LED



95848

LED

### 95847 PINEDA

recessed light; plastic, white  
 Einbauleuchte; Kunststoff, weiss  
 luminaire encastrable; plastique, blanc



### 95849 PINEDA

recessed light; plastic, satin nickel  
 Einbauleuchte; Kunststoff, nickel-matt  
 luminaire encastrable; plastique, nickel mat

### 95848 PINEDA

recessed light; plastic, chrome  
 Einbauleuchte; Kunststoff, chrom  
 luminaire encastrable; plastique, chrome

Ø 84, ET 40

LED 1x 6W  
 warm WHITE 1x 500lm  
  
  
 Ø72



9 002759 958473



Ø 84



Ø 84, ET 40

LED 1x 6W  
 warm WHITE 1x 500lm  
  
  
 Ø72



9 002759 958497



Ø 84



Ø 84, ET 40

LED 1x 6W  
 warm WHITE 1x 500lm  
  
  
 Ø72



9 002759 958480



Ø 84





95851



95853



95852



### 95851 PINEDA

recessed light; plastic, white  
 Einbauleuchte; Kunststoff, weiss  
 luminaire encastrable; plastique, blanc

### 95853 PINEDA

recessed light; plastic, satin nickel  
 Einbauleuchte; Kunststoff, nickel-matt  
 luminaire encastrable; plastique, nickel mat

### 95852 PINEDA

recessed light; plastic, chrome  
 Einbauleuchte; Kunststoff, chrom  
 luminaire encastrable; plastique, chrome

Ø 84, ET 40



9 002759 958510



Ø 84



Ø 84, ET 40



9 002759 958534



Ø 84



Ø 84, ET 40



9 002759 958527



Ø 84





95841

LED



95844

LED

### 95841 PINEDA

recessed light; plastic, white  
 Einbauleuchte; Kunststoff, weiss  
 luminaire encastrable; plastique, blanc

L 84, B 84, ET 40



9 002759 958411



### 95844 PINEDA

recessed light; plastic, white  
 Einbauleuchte; Kunststoff, weiss  
 luminaire encastrable; plastique, blanc

L 84, B 84, ET 40



9 002759 958442





95843

LED



95846

LED



### 95843 PINEDA

recessed light; plastic, satin nickel  
 Einbauleuchte; Kunststoff, nickel-matt  
 luminaire encastrable; plastique, nickel mat

L 84, B 84, ET 40

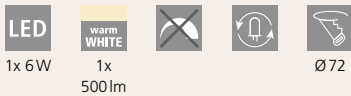

### 95846 PINEDA

recessed light; plastic, satin nickel  
 Einbauleuchte; Kunststoff, nickel-matt  
 luminaire encastrable; plastique, nickel mat

L 84, B 84, ET 40







32896



### 32896 SARTIANO

recessed light; plastic, white  
 Einbauleuchte; Kunststoff, weiss  
 luminaire encastrable; plastique, blanc

Ø 90, ET 45

3x 5W	3x 470lm	Ø 73	





32896



95854



95856



95855



### 95854 PINEDA

recessed light; plastic, white  
 Einbauleuchte; Kunststoff, weiss  
 luminaire encastrable; plastique, blanc

### 95856 PINEDA

recessed light; plastic, satin nickel  
 Einbauleuchte; Kunststoff, nickel-matt  
 luminaire encastrable; plastique, nickel mat

### 95855 PINEDA

recessed light; plastic, chrome  
 Einbauleuchte; Kunststoff, chrom  
 luminaire encastrable; plastique, chrome

Ø 84, ET 40



9 002759 958541



Ø 84

Ø 84, ET 40



9 002759 958565



Ø 84

Ø 84, ET 40



9 002759 958558



Ø 84



95857



95859



95858



### 95857 PINEDA

recessed light; plastic, white  
 Einbauleuchte; Kunststoff, weiss  
 luminaire encastrable; plastique, blanc

### 95859 PINEDA

recessed light; plastic, satin nickel  
 Einbauleuchte; Kunststoff, nickel-matt  
 luminaire encastrable; plastique, nickel mat

### 95858 PINEDA

recessed light; plastic, chrome  
 Einbauleuchte; Kunststoff, chrom  
 luminaire encastrable; plastique, chrome

Ø 84, ET 40



9 002759 958572



Ø 84

Ø 84, ET 40



9 002759 958596



Ø 84

Ø 84, ET 40



9 002759 958589



Ø 84



98243



98244



98607



### 98243 SALICETO

recessed light; aluminium, white  
Einbauleuchte; Alu, weiss  
luminaire encastrable; aluminium, blanc

H 42, Ø 88, ET 50



### 98244 SALICETO

recessed light; aluminium, satin nickel  
Einbauleuchte; Alu, nickel-matt  
luminaire encastrable; aluminium, nickel mat

H 42, Ø 88, ET 50



### 98607 SALICETO

recessed light; aluminium, black  
Einbauleuchte; Alu, schwarz  
luminaire encastrable; aluminium, noir

H 42, Ø 88, ET 50







98245



98246



98244

### 98245 SALICETO

recessed light; aluminium, white  
Einbauleuchte; Alu, weiss  
luminaire encastrable; aluminium, blanc

H 42, Ø 88, ET 50



### 98246 SALICETO

recessed light; aluminium, satin nickel  
Einbauleuchte; Alu, nickel-matt  
luminaire encastrable; aluminium, nickel mat

H 42, Ø 88, ET 50



9 002759 982454



Ø 88



9 002759 982461



Ø 88



98472



98473



98471



### 98471 SALICETO

recessed light; aluminium, white / glass, clear  
 Einbauleuchte; Alu, weiss / Glas, klar  
 luminaire encastrable; aluminium, blanc / verre, clair

L 88, B 88, H 42, ET 50



6W 380lm



9 002759 984717



### 98472 SALICETO

recessed light; aluminium, satin nickel / glass, clear  
 Einbauleuchte; Alu, nickel-matt / Glas, klar  
 luminaire encastrable; aluminium, nickel mat / verre, clair

L 88, B 88, H 42, ET 50



6W 380lm

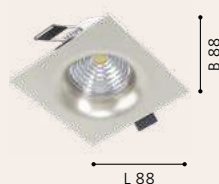

9 002759 984724



### 98473 SALICETO

recessed light; aluminium, white / glass, clear  
 Einbauleuchte; Alu, weiss / Glas, klar  
 luminaire encastrable; aluminium, blanc / verre, clair

L 88, B 88, H 42, ET 50



6W 450lm



9 002759 984731





98474



98474

### 98474 SALICETO

recessed light; aluminium, satin nickel / glass, clear  
 Einbauleuchte; Alu, nickel-matt / Glas, klar  
 luminaire encastrable; aluminium, nickel mat / verre, clair

L 88, B 88, H 42, ET 50

LED

6W

neutral  
WHITE

450lm



Ø68



9 002759 984748

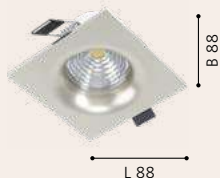



98301

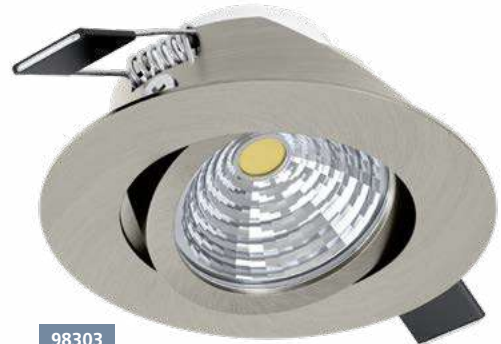

98303



98609



### 98301 SALICETO

recessed light; aluminium, white  
 Einbauleuchte; Alu, weiss  
 luminaire encastrable; aluminium, blanc

### 98303 SALICETO

recessed light; aluminium, satin nickel  
 Einbauleuchte; Alu, nickel-matt  
 luminaire encastrable; aluminium, nickel mat

### 98609 SALICETO

recessed light; aluminium, black  
 Einbauleuchte; Alu, schwarz  
 luminaire encastrable; aluminium, noir

H 42, Ø 88, ET 50



6W 380lm



Ø 88

H 42, Ø 88, ET 50



6W 380lm



Ø 88

H 42, Ø 88, ET 50



6W 380lm



Ø 88



9 002759 983017



9 002759 983031



9 002759 986094





98305



98301



98307



### 98305 SALICETO

recessed light; aluminium, white  
 Einbauleuchte; Alu, weiss  
 luminaire encastrable; aluminium, blanc

H 42, Ø 88, ET 50



6W 450lm

Ø68

### 98307 SALICETO

recessed light; aluminium, satin nickel  
 Einbauleuchte; Alu, nickel-matt  
 luminaire encastrable; aluminium, nickel mat

H 42, Ø 88, ET 50



6W 450lm

Ø68



9 002759 983055



Ø 88



9 002759 983079



Ø 88







98302



98304



98611



### 98302 SALICETO

recessed light; aluminium, white  
 Einbauleuchte; Alu, weiss  
 luminaire encastrable; aluminium, blanc

### 98304 SALICETO

recessed light; aluminium, satin nickel  
 Einbauleuchte; Alu, nickel-matt  
 luminaire encastrable; aluminium, nickel mat

### 98611 SALICETO

recessed light; aluminium, black  
 Einbauleuchte; Alu, schwarz  
 luminaire encastrable; aluminium, noir

L 88, B 88, H 42, ET 50



6W 380lm

Ø68

L 88, B 88, H 42, ET 50



6W 380lm

Ø68

L 88, B 88, H 42, ET 50



6W 380lm

Ø68



9 002759 983024



L 88

B 88



9 002759 983048



L 88

B 88



9 002759 986117



L 88

B 88





98306



LED

98308



LED

### 98306 SALICETO

recessed light; aluminium, white  
 Einbauleuchte; Alu, weiss  
 luminaire encastrable; aluminium, blanc

L 88, B 88, H 42, ET 50



6W

450lm

Ø68

### 98308 SALICETO

recessed light; aluminium, satin nickel  
 Einbauleuchte; Alu, nickel-matt  
 luminaire encastrable; aluminium, nickel mat

L 88, B 88, H 42, ET 50



6W

450lm

Ø68



9 002759 983062



L 88

B 88



9 002759 983086



L 88

B 88



98308



98238



IP44



98239



IP44



98241



IP44

### 98238 SALABATE

recessed light; aluminium, white / glass, clear  
 Einbauleuchte; Alu, weiss / Glas, klar  
 luminaire encastrable; aluminium, blanc / verre, clair

H 68, Ø 88, ET 52

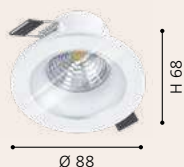

### 98239 SALABATE

recessed light; aluminium, white / glass, clear  
 Einbauleuchte; Alu, weiss / Glas, klar  
 luminaire encastrable; aluminium, blanc / verre, clair

L 88, B 88, H 68, ET 52



### 98241 SALABATE

recessed light; aluminium, white / glass, clear  
 Einbauleuchte; Alu, weiss / Glas, klar  
 luminaire encastrable; aluminium, blanc / verre, clair

H 68, Ø 88, ET 52





98242



IP44



98241

### 98242 SALABATE

recessed light; aluminium, white / glass, clear  
 Einbauleuchte; Alu, weiss / Glas, klar  
 luminaire encastrable; aluminium, blanc / verre, clair

L 88, B 88, H 68, ET 52



6W



450lm



Ø68



IP20, IP44



9 002759 982423



L 88

B 88





95817  
LED IP44



95819  
LED IP44



95818  
LED IP44

### 95817 PINEDA

recessed light; plastic, white  
Einbauleuchte; Kunststoff, weiss  
luminaire encastrable; plastique, blanc

### 95819 PINEDA

recessed light; plastic, satin nickel  
Einbauleuchte; Kunststoff, nickel-matt  
luminaire encastrable; plastique, nickel mat

### 95818 PINEDA

recessed light; plastic, chrome  
Einbauleuchte; Kunststoff, chrom  
luminaire encastrable; plastique, chrome

Ø 78, ET 35

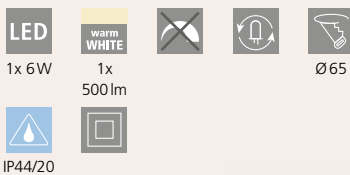

Ø 78

Ø 78, ET 35



Ø 78

Ø 78, ET 35

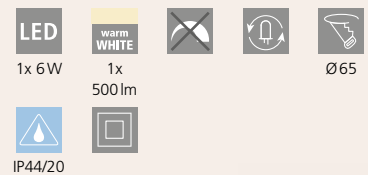

Ø 78





95821



IP44



95822



IP44



95823



IP44



### 95821 PINEDA

recessed light; plastic, white  
 Einbauleuchte; Kunststoff, weiss  
 luminaire encastrable; plastique, blanc

### 95823 PINEDA

recessed light; plastic, satin nickel  
 Einbauleuchte; Kunststoff, nickel-matt  
 luminaire encastrable; plastique, nickel mat

### 95822 PINEDA

recessed light; plastic, chrome  
 Einbauleuchte; Kunststoff, chrom  
 luminaire encastrable; plastique, chrome

Ø 78, ET 35

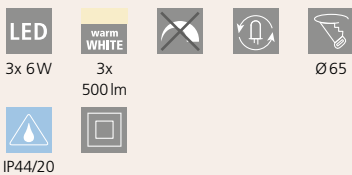

9 002759 958213



Ø 78

Ø 78, ET 35

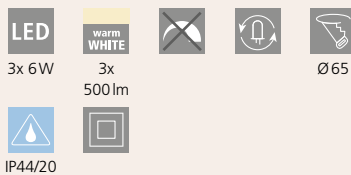

9 002759 958237



Ø 78

Ø 78, ET 35

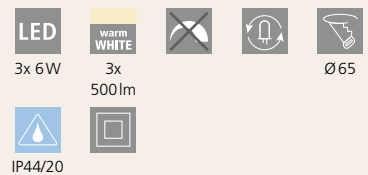

9 002759 958220



Ø 78

95887, 99888, 99889

These luminaires are protected against splash water.

Diese Leuchten sind gegen Spritzwasser geschützt.

Les luminaires sont protégées contre les éclaboussures d'eau.



95887



IP44



IP44

	0	1	2	3
EU	X	X	✓	✓
FR	X	X	X	✓



95888



IP44



95889



IP44

95887 PINEDA

recessed light; plastic, white  
Einbauleuchte; Kunststoff, weiss  
luminaire encastrable; plastique, blanc

Ø 102, ET 35

LED 1x 12W warm WHITE 1x 1000lm

Ø87

IP44/20



9 002759 958879



Ø 102



95889 PINEDA

recessed light; plastic, satin nickel  
Einbauleuchte; Kunststoff, nickel-matt  
luminaire encastrable; plastique, nickel mat

Ø 102, ET 35

LED 1x 12W warm WHITE 1x 1000lm

Ø87

IP44/20



9 002759 958893



Ø 102



95888 PINEDA

recessed light; plastic, chrome  
Einbauleuchte; Kunststoff, chrom  
luminaire encastrable; plastique, chrome

Ø 102, ET 35

LED 1x 12W warm WHITE 1x 1000lm

Ø87

IP44/20



9 002759 958886



Ø 102





95889



95917



IP44



95918



IP44



95962



IP44

### 95917 PINEDA 1

recessed light; steel, plastic, white / plastic, white  
 Einbauleuchte; Stahl, Kunststoff, weiss / Kunststoff, weiss  
 luminaire encastrable; acier, plastique, blanc / plastique, blanc

Ø 82, ET 35



9 002759 959173



Ø 82

### 95918 PINEDA 1

recessed light; steel, plastic, satin nickel / plastic, white  
 Einbauleuchte; Stahl, Kunststoff, nickel-matt / Kunststoff, weiss  
 luminaire encastrable; acier, plastique, nickel mat / plastique, blanc

Ø 82, ET 35



9 002759 959180



Ø 82

### 95962 PINEDA 1

recessed light; steel, plastic, chrome / plastic, white  
 Einbauleuchte; Stahl, Kunststoff, chrom / Kunststoff, weiss  
 luminaire encastrable; acier, plastique, chrome / plastique, blanc

Ø 82, ET 35



9 002759 959623



Ø 82





95932



### 95932 PINEDA 1

recessed light; steel, plastic, white, satin nickel / plastic, clear, satiné

Einbauleuchte; Stahl, Kunststoff, weiss, nickel-matt / Kunststoff, klar, satiniert

luminaire encastrable; acier, plastique, blanc, nickel mat /

plastique, clair, satiné

Ø 145, ET 35

LED

1x 12W

warm  
WHITE

1x

1000lm



Ø 90



Ø 145







96901

LED



96902

LED

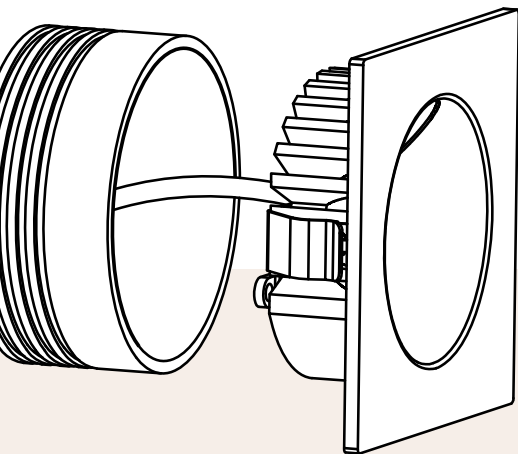

**96901 & 96902**

including plaster ring

inklusive Einputzring

y compris l'anneau de plâtre

**96901 ZARATE**

recessed light; cast aluminium, white / plastic, white  
 Einbauleuchte; Aluguss, weiss / Kunststoff, weiss  
 luminaire encastrable; fonte d'aluminium, blanc / plastique, blanc

L 80, H 80, ET 40



**96902 ZARATE**

recessed light; cast aluminium, silver / plastic, white  
 Einbauleuchte; Aluguss, silber / Kunststoff, weiss  
 luminaire encastrable; fonte d'aluminium, argent / plastique, blanc

L 80, H 80, ET 40





96902



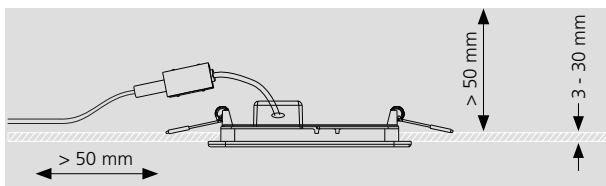

# RECESSED LUMINAIRES

## FUEVA 5

### ADVANTAGES

- > NEW, MODERN APPEARANCE - THE NEW FUEVA CONVINCES WITH ITS FLAT DESIGN AND NARROW FRAME.
- > NEW COLOUR - THE FUEVA 5 IS AVAILABLE IN THE NEW TREND COLOUR BLACK.
- > INCLUSIVE PLUG-IN TERMINAL - FOR QUICK WORK AND EASY HANDLING

---

### VORTEILE

- > NEUES, MODERNES ERSCHEINUNGSBILD - DIE NEUE FUEVA ÜBERZEUGT DURCH IHR FLACHES DESIGN SOWIE DEN SCHMALEN RAHMEN.
- > NEUE FARBE - DIE FUEVA 5 IST IN DER NEUEN TRENDFARBE SCHWARZ ERHÄLTlich.
- > INKLUSIVE STECKKLEMME - FÜR DAS SCHNELLE ARBEITEN UND EINE EINFACHE HANDHABUNG

---

### ADVANTAGES

- > NOUVELLE APPARENCE MODERNE - LE NOUVEAU FUEVA CONVAINC PAR SON DESIGN PLAT ET SON CADRE ÉTROIT.
- > NOUVELLE COULEUR - LE FUEVA 5 EST DISPONIBLE DANS LA NOUVELLE COULEUR TENDANCE NOIRE.
- > Y COMPRIS UNE BORNE ENFICHABLE - POUR UN TRAVAIL RAPIDE ET UNE MANIPULATION SIMPLE

# OVERVIEW

**5** year warranty  
Jahre Garantie  
ans de garantie  
anni di garanzia  
años de garantía  
anos de garantía



FUEVA 5  
122



FUEVA 5  
122



FUEVA 5  
123



FUEVA 5  
123



FUEVA 5  
124



FUEVA 5  
124



FUEVA 5  
125



FUEVA 5  
125



FUEVA 5  
126



FUEVA 5  
126



FUEVA 5  
127



FUEVA 5  
127



FUEVA 5  
128



FUEVA 5  
128



FUEVA 5  
129



FUEVA 5  
130



FUEVA 5  
130



FUEVA 5  
131



FUEVA 5  
132



FUEVA 5  
132



FUEVA 5  
133



FUEVA 5  
134

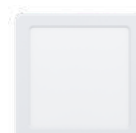

FUEVA 5  
134



FUEVA 5  
135



FUEVA 5  
135



FUEVA 5  
136



FUEVA 5  
136



FUEVA 5  
137



FUEVA 5  
137



FUEVA 5  
139



FUEVA 5  
139



FUEVA 5  
141



FUEVA 5  
141



FUEVA 5  
142



FUEVA 5  
142



FUEVA 5  
143



FUEVA 5  
144



FUEVA 5  
144



FUEVA 5  
145



FUEVA 5  
146



FUEVA 5  
146



FUEVA 5  
147

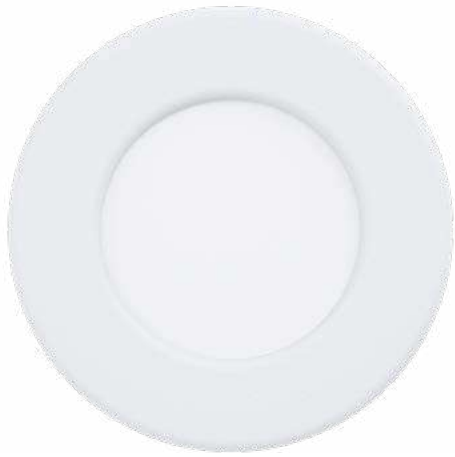

99131

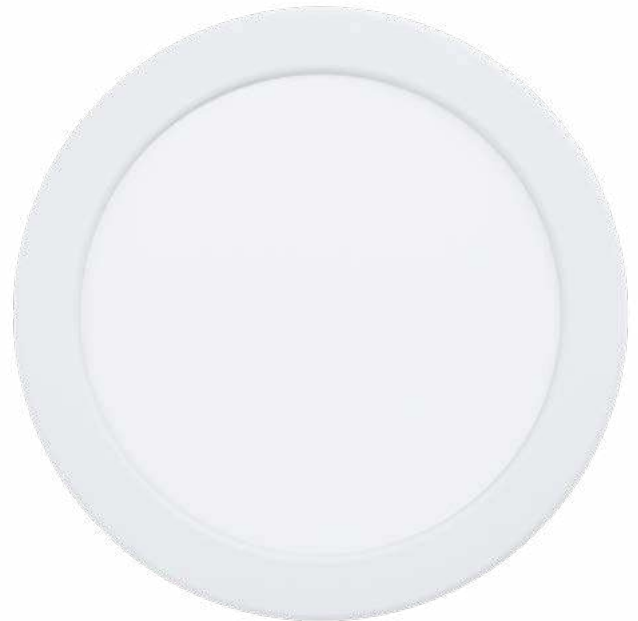

99133

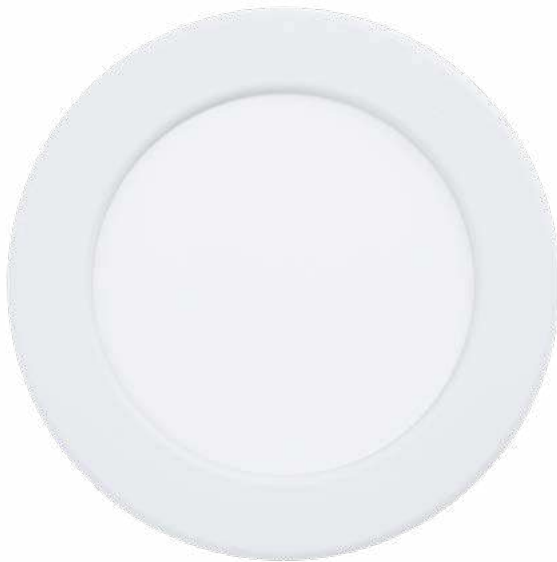

99132



### 99131 FUEVA 5

recessed light; steel, white / plastic, white  
Einbauleuchte; Stahl, weiss / Kunststoff, weiss  
luminaire encastrable; acier, blanc / plastique, blanc

Ø 86, ET 26



2,7W 300lm

Ø 75

### 99132 FUEVA 5

recessed light; steel, white / plastic, white  
Einbauleuchte; Stahl, weiss / Kunststoff, weiss  
luminaire encastrable; acier, blanc / plastique, blanc

Ø 117, ET 26



5,5W 650lm

Ø 105

### 99133 FUEVA 5

recessed light; steel, white / plastic, white  
Einbauleuchte; Stahl, weiss / Kunststoff, weiss  
luminaire encastrable; acier, blanc / plastique, blanc

Ø 166, ET 26



10,5W 1200lm

Ø 155



9 002759 991319



Ø 86



9 002759 991326



Ø 117



9 002759 991333



Ø 166



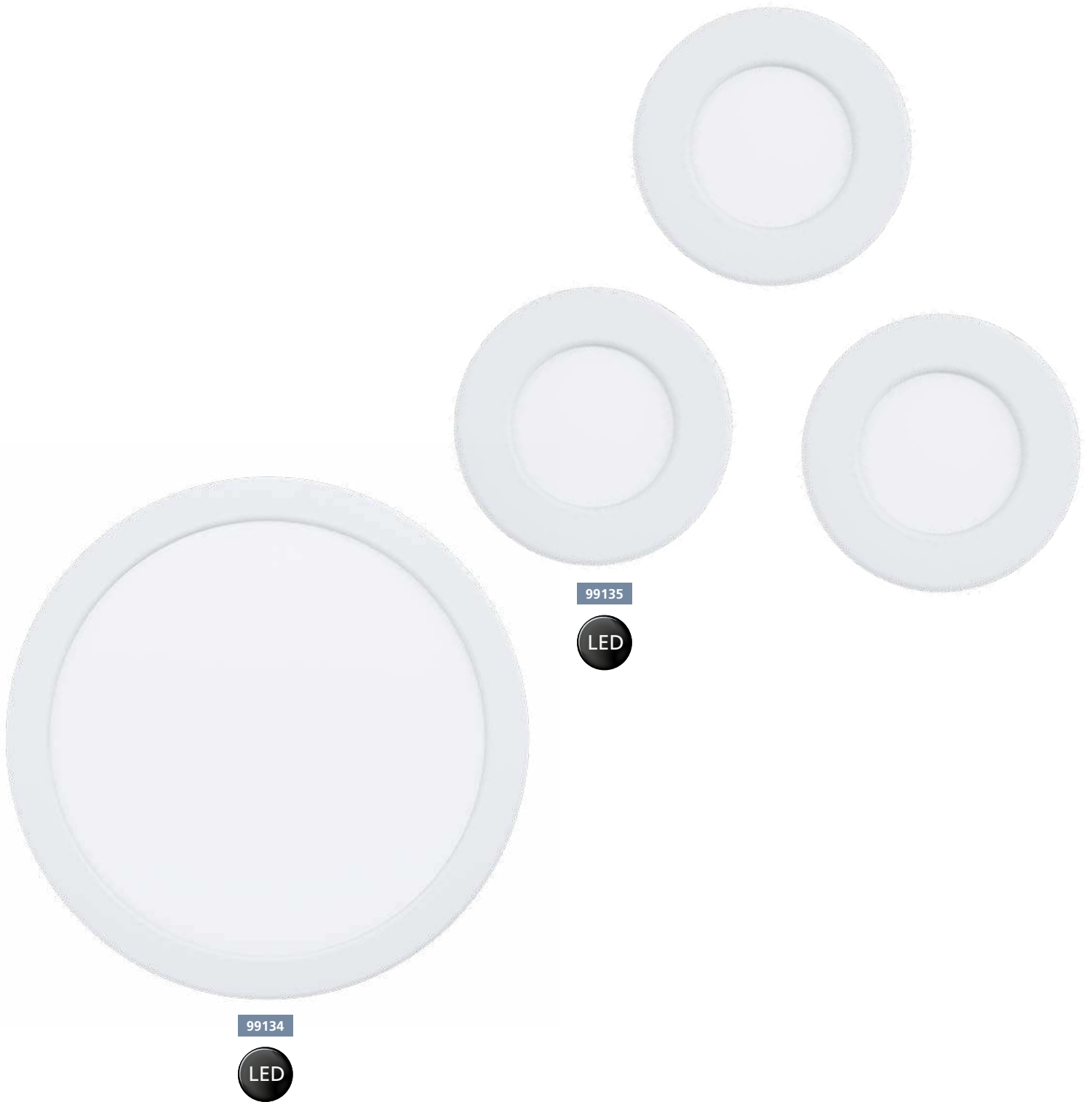

99134



99135



### 99134 FUEVA 5

recessed light; steel, white / plastic, white  
 Einbauleuchte; Stahl, weiss / Kunststoff, weiss  
 luminaire encastrable; acier, blanc / plastique, blanc

Ø 216, ET 26



16,5W 1800lm

Ø205

### 99135 FUEVA 5

recessed light; steel, white / plastic, white  
 Einbauleuchte; Stahl, weiss / Kunststoff, weiss  
 luminaire encastrable; acier, blanc / plastique, blanc

Ø 86, ET 26



3x 2,7W 3x 300lm

Ø75



9 002759 991340



Ø 216



9 002759 991357



Ø 86





99136



99137



99138



### 99136 FUEVA 5

recessed light; steel, satin nickel / plastic, white  
Einbauleuchte; Stahl, nickel-matt / Kunststoff, weiss  
luminaire encastrable; acier, nickel mat / plastique, blanc

Ø 86, ET 26



2,7W 300lm

Ø 75



9 002759 991364



Ø 86

### 99137 FUEVA 5

recessed light; steel, satin nickel / plastic, white  
Einbauleuchte; Stahl, nickel-matt / Kunststoff, weiss  
luminaire encastrable; acier, nickel mat / plastique, blanc

Ø 117, ET 26



5,5W 650lm

Ø 105



9 002759 991371



Ø 117

### 99138 FUEVA 5

recessed light; steel, satin nickel / plastic, white  
Einbauleuchte; Stahl, nickel-matt / Kunststoff, weiss  
luminaire encastrable; acier, nickel mat / plastique, blanc

Ø 166, ET 26



10,5W 1200lm

Ø 155



9 002759 991388



Ø 166



99139



99141



### 99139 FUEVA 5

recessed light; steel, satin nickel / plastic, white  
 Einbauleuchte; Stahl, nickel-matt / Kunststoff, weiss  
 luminaire encastrable; acier, nickel mat / plastique, blanc

Ø 216, ET 26



16,5W 1800lm

Ø205

### 99141 FUEVA 5

recessed light; steel, satin nickel / plastic, white  
 Einbauleuchte; Stahl, nickel-matt / Kunststoff, weiss  
 luminaire encastrable; acier, nickel mat / plastique, blanc

Ø 86, ET 26



3x 2,7W 3x 300lm

Ø75



9 002759 991395



Ø 216



9 002759 991418



Ø 86



99142

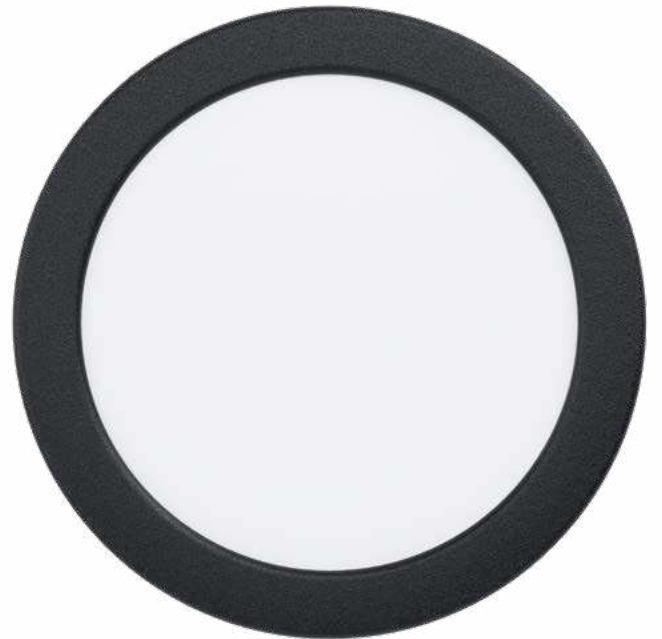

99144



99143



### 99142 FUEVA 5

recessed light; steel, black / plastic, white  
Einbauleuchte; Stahl, schwarz / Kunststoff, weiss  
luminaire encastrable; acier, noir / plastique, blanc

Ø 86, ET 26



2,7W 300lm

Ø 75



9 002759 991425



Ø 86

### 99143 FUEVA 5

recessed light; steel, black / plastic, white  
Einbauleuchte; Stahl, schwarz / Kunststoff, weiss  
luminaire encastrable; acier, noir / plastique, blanc

Ø 117, ET 26



5,5W 650lm

Ø 105



9 002759 991432



Ø 117

### 99144 FUEVA 5

recessed light; steel, black / plastic, white  
Einbauleuchte; Stahl, schwarz / Kunststoff, weiss  
luminaire encastrable; acier, noir / plastique, blanc

Ø 166, ET 26



10,5W 1200lm

Ø 155



9 002759 991449



Ø 166

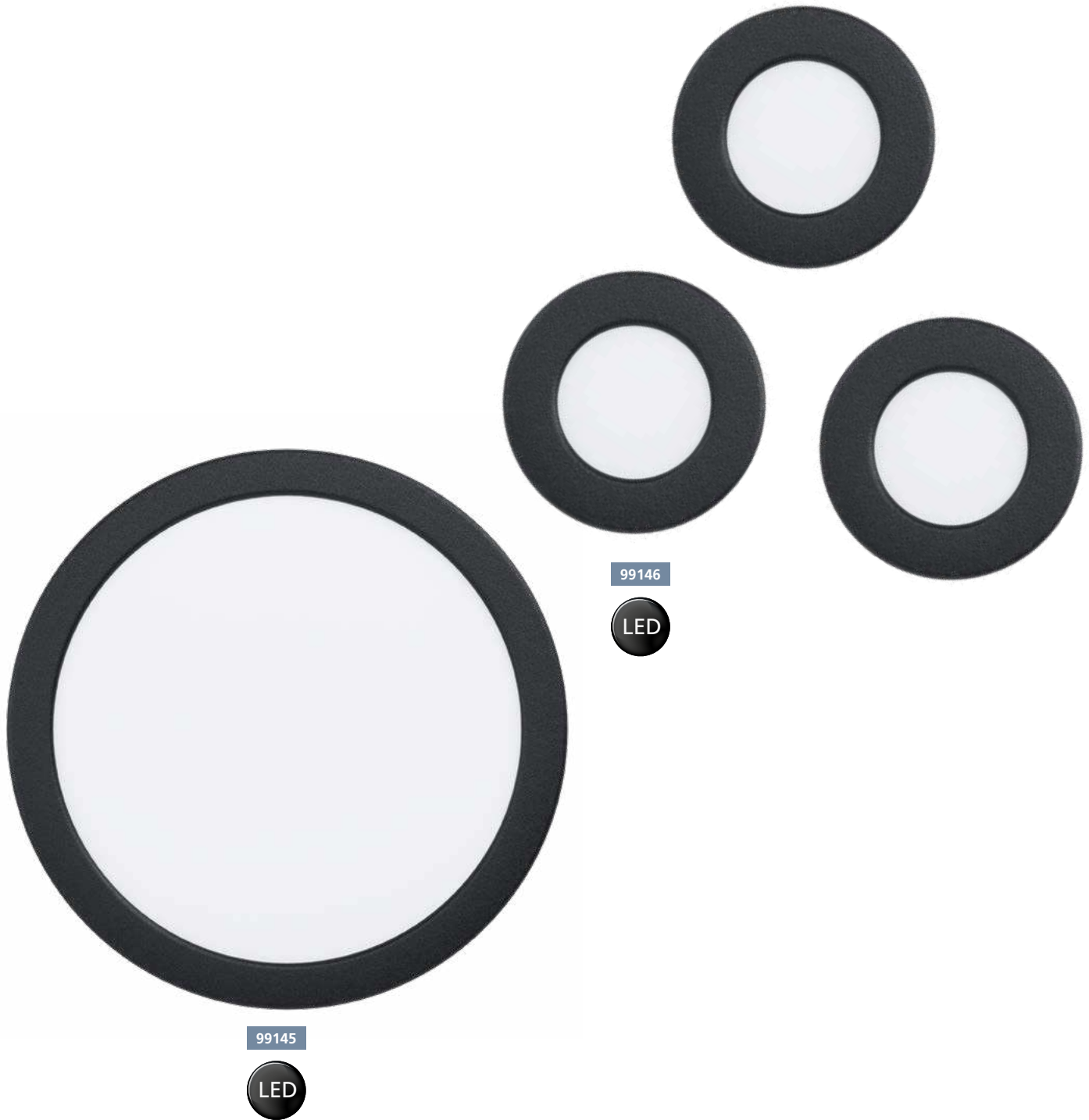

99145

LED

99146

LED

### 99145 FUEVA 5

recessed light; steel, black / plastic, white  
 Einbauleuchte; Stahl, schwarz / Kunststoff, weiss  
 luminaire encastrable; acier, noir / plastique, blanc

Ø 216, ET 26



16,5W 1800lm

Ø205

### 99146 FUEVA 5

recessed light; steel, black / plastic, white  
 Einbauleuchte; Stahl, schwarz / Kunststoff, weiss  
 luminaire encastrable; acier, noir / plastique, blanc

Ø 86, ET 26



3x 2,7W 3x 300lm

Ø75



9 002759 991456



Ø 216



9 002759 991463



Ø 86



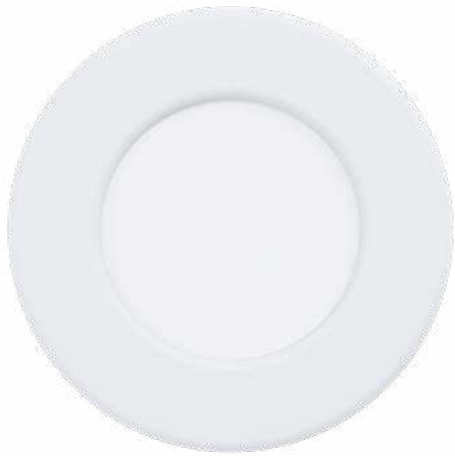

99147

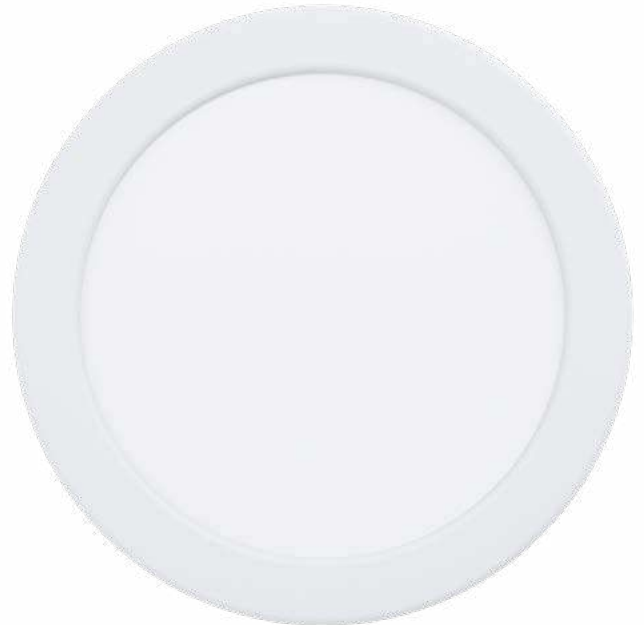

99149

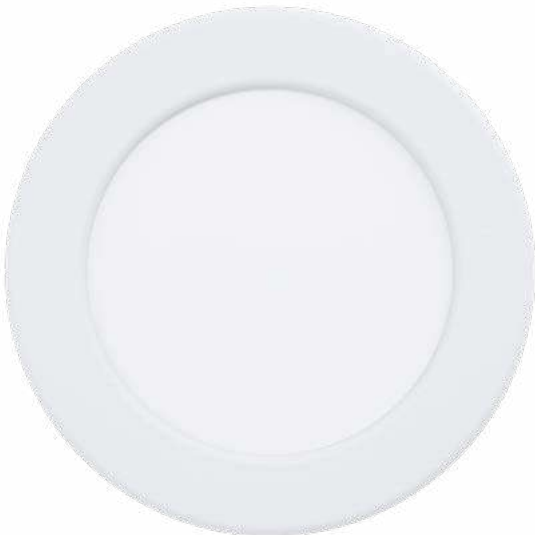

99148



### 99147 FUEVA 5

recessed light; steel, white / plastic, white  
Einbauleuchte; Stahl, weiss / Kunststoff, weiss  
luminaire encastrable; acier, blanc / plastique, blanc

Ø 86, ET 26



2,7W 360lm

Ø 75



9 002759 991470



Ø 86

### 99148 FUEVA 5

recessed light; steel, white / plastic, white  
Einbauleuchte; Stahl, weiss / Kunststoff, weiss  
luminaire encastrable; acier, blanc / plastique, blanc

Ø 117, ET 26



5,5W 700lm

Ø 105



9 002759 991487



Ø 117

### 99149 FUEVA 5

recessed light; steel, white / plastic, white  
Einbauleuchte; Stahl, weiss / Kunststoff, weiss  
luminaire encastrable; acier, blanc / plastique, blanc

Ø 166, ET 26



10,5W 1350lm

Ø 155



9 002759 991494



Ø 166

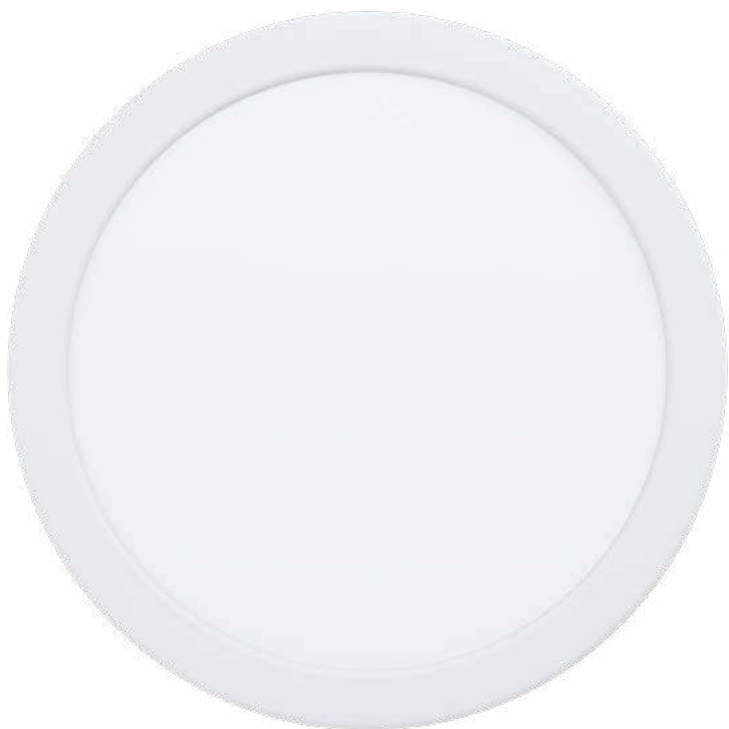

99151



### 99151 FUEVA 5

recessed light; steel, white / plastic, white  
Einbauleuchte; Stahl, weiss / Kunststoff, weiss  
luminaire encastrable; acier, blanc / plastique, blanc

Ø 216, ET 26



16,5W 2000lm

Ø205



Ø 216



99151



99152



99154



99153



### 99152 FUEVA 5

recessed light; steel, satin nickel / plastic, white  
Einbauleuchte; Stahl, nickel-matt / Kunststoff, weiss  
luminaire encastrable; acier, nickel mat / plastique, blanc

Ø 86, ET 26



2,7W 360lm

Ø 75



9 002759 991524



Ø 86

### 99153 FUEVA 5

recessed light; steel, satin nickel / plastic, white  
Einbauleuchte; Stahl, nickel-matt / Kunststoff, weiss  
luminaire encastrable; acier, nickel mat / plastique, blanc

Ø 117, ET 26



5,5W 700lm

Ø 105



9 002759 991531



Ø 117

### 99154 FUEVA 5

recessed light; steel, satin nickel / plastic, white  
Einbauleuchte; Stahl, nickel-matt / Kunststoff, weiss  
luminaire encastrable; acier, nickel mat / plastique, blanc

Ø 166, ET 26



10,5W 1350lm

Ø 155



9 002759 991548



Ø 166



99155



### 99155 FUEVA 5

recessed light; steel, satin nickel / plastic, white  
Einbauleuchte; Stahl, nickel-matt / Kunststoff, weiss  
luminaire encastrable; acier, nickel mat / plastique, blanc

Ø 216, ET 26

LED

16,5W

neutral  
WHITE

2000lm



Ø205



9 002759 991555



Ø 216



99155



99156



99158



99157



### 99156 FUEVA 5

recessed light; steel, black / plastic, white  
Einbauleuchte; Stahl, schwarz / Kunststoff, weiss  
luminaire encastrable; acier, noir / plastique, blanc

Ø 86, ET 26



2,7W 360lm

Ø 75

### 99157 FUEVA 5

recessed light; steel, black / plastic, white  
Einbauleuchte; Stahl, schwarz / Kunststoff, weiss  
luminaire encastrable; acier, noir / plastique, blanc

Ø 117, ET 26



5,5W 700lm

Ø 105

### 99158 FUEVA 5

recessed light; steel, black / plastic, white  
Einbauleuchte; Stahl, schwarz / Kunststoff, weiss  
luminaire encastrable; acier, noir / plastique, blanc

Ø 166, ET 26



10,5W 1350lm

Ø 155



9 002759 991562



Ø 86



9 002759 991579



Ø 117



9 002759 991586



Ø 166



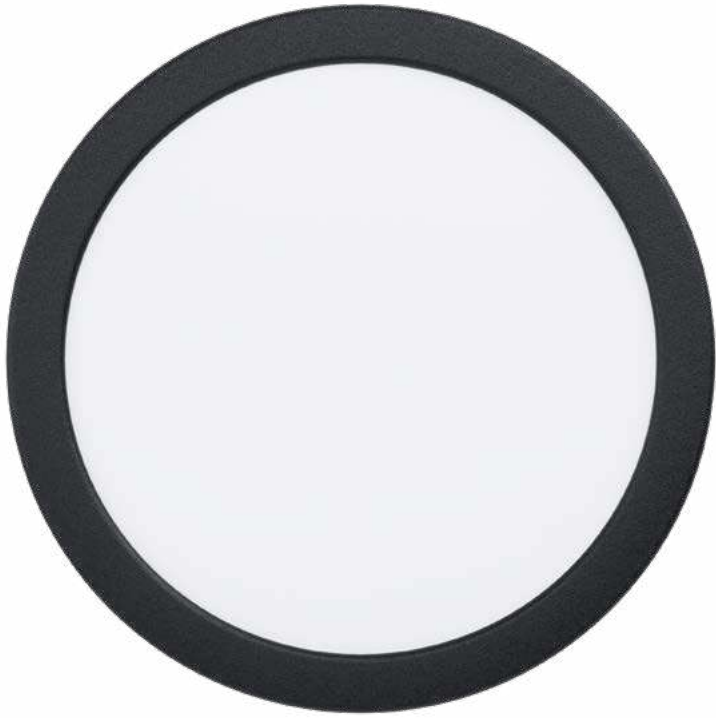

99159



99158

### 99159 FUEVA 5

recessed light; steel, black / plastic, white  
Einbauleuchte; Stahl, schwarz / Kunststoff, weiss  
luminaire encastrable; acier, noir / plastique, blanc

Ø 216, ET 26



16,5W 2000lm

Ø205



9 002759 991593



Ø 216

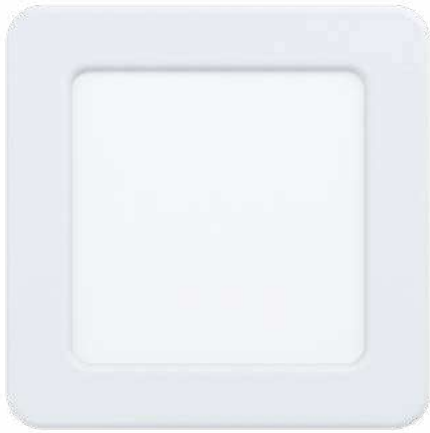

99162

LED

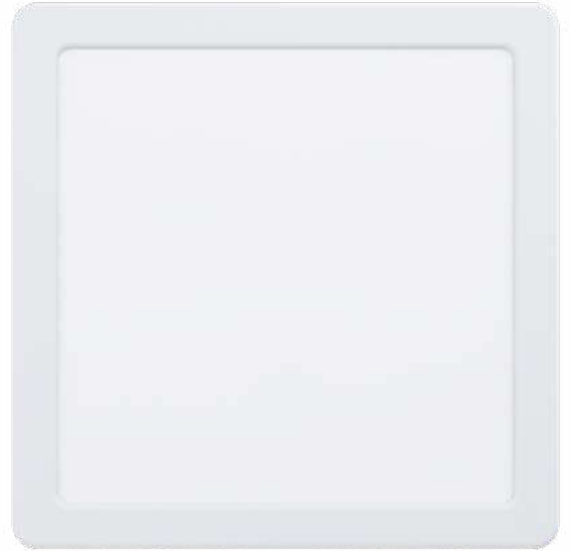

99164

LED

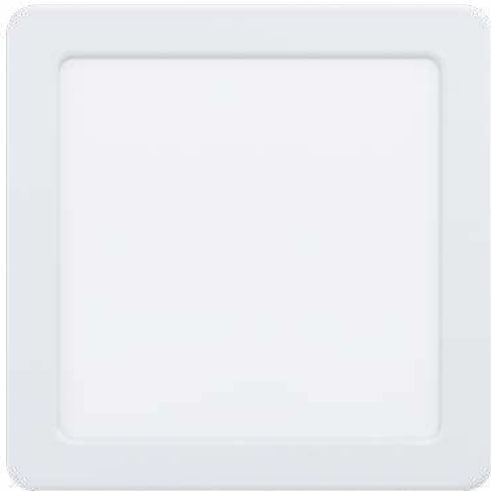

99163

LED

### 99162 FUEVA 5

recessed light; steel, white / plastic, white  
Einbauleuchte; Stahl, weiss / Kunststoff, weiss  
luminaire encastrable; acier, blanc / plastique, blanc

L 117, B 117, ET 26



5,5W 650lm 105x105



9 002759 991623

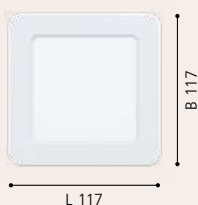

L 117



9 002759 991630



### 99163 FUEVA 5

recessed light; steel, white / plastic, white  
Einbauleuchte; Stahl, weiss / Kunststoff, weiss  
luminaire encastrable; acier, blanc / plastique, blanc

L 166, B 166, ET 26



10,5W 1200lm 155x155

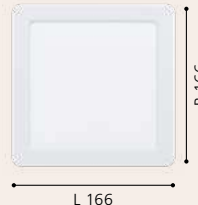

L 166

### 99164 FUEVA 5

recessed light; steel, white / plastic, white  
Einbauleuchte; Stahl, weiss / Kunststoff, weiss  
luminaire encastrable; acier, blanc / plastique, blanc

L 216, B 216, ET 26



16,5W 1800lm 205x205



9 002759 991647

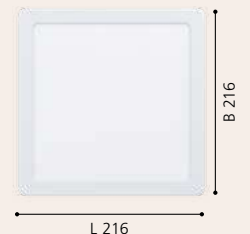

L 216



99167

LED



99169

LED



99168

LED

### 99167 FUEVA 5

recessed light; steel, satin nickel / plastic, white  
Einbauleuchte; Stahl, nickel-matt / Kunststoff, weiss  
luminaire encastrable; acier, nickel mat / plastique, blanc

L 117, B 117, ET 26



5,5W 650lm 105x105



9 002759 991678

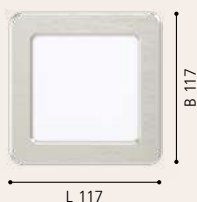

### 99168 FUEVA 5

recessed light; steel, satin nickel / plastic, white  
Einbauleuchte; Stahl, nickel-matt / Kunststoff, weiss  
luminaire encastrable; acier, nickel mat / plastique, blanc

L 166, B 166, ET 26



10,5W 1200lm 155x155



9 002759 991685



### 99169 FUEVA 5

recessed light; steel, satin nickel / plastic, white  
Einbauleuchte; Stahl, nickel-matt / Kunststoff, weiss  
luminaire encastrable; acier, nickel mat / plastique, blanc

L 216, B 216, ET 26



16,5W 1800lm 205x205



9 002759 991692



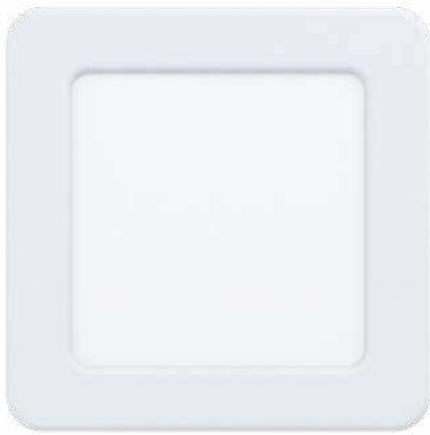

99178

LED

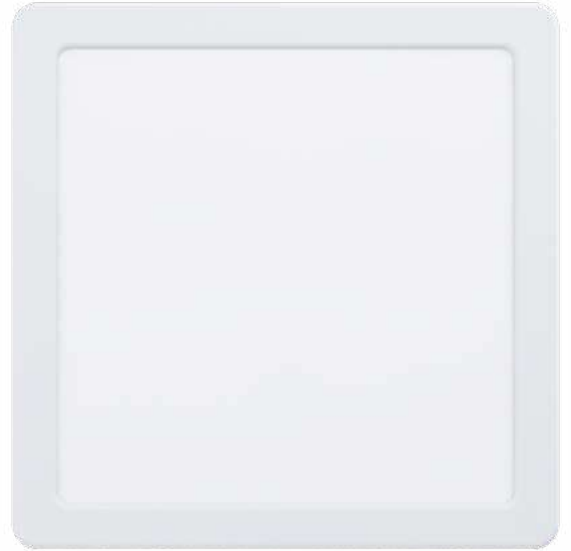

99181

LED

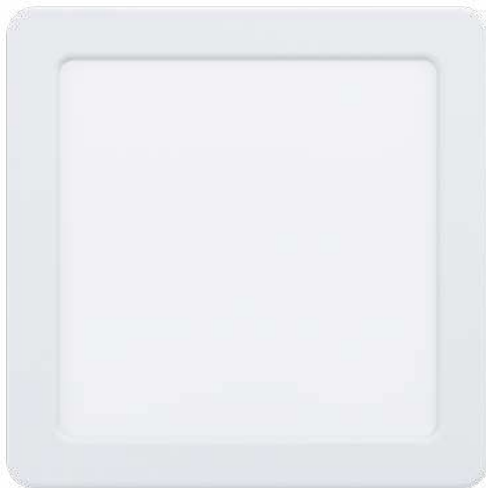

99179

LED

### 99178 FUEVA 5

recessed light; steel, white / plastic, white  
Einbauleuchte; Stahl, weiss / Kunststoff, weiss  
luminaire encastrable; acier, blanc / plastique, blanc

L 117, B 117, ET 26



5,5W 700lm 105x105

### 99179 FUEVA 5

recessed light; steel, white / plastic, white  
Einbauleuchte; Stahl, weiss / Kunststoff, weiss  
luminaire encastrable; acier, blanc / plastique, blanc

L 166, B 166, ET 26



10,5W 1350lm 155x155

### 99181 FUEVA 5

recessed light; steel, white / plastic, white  
Einbauleuchte; Stahl, weiss / Kunststoff, weiss  
luminaire encastrable; acier, blanc / plastique, blanc

L 216, B 216, ET 26



16,5W 2000lm 205x205



9 002759 991784

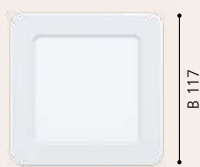

L 117



9 002759 991791



L 166



9 002759 991814

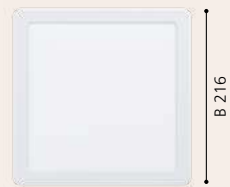

L 216

B 216



99183



99185



99184



### 99183 FUEVA 5

recessed light; steel, satin nickel / plastic, white  
 Einbauleuchte; Stahl, nickel-matt / Kunststoff, weiss  
 luminaire encastrable; acier, nickel mat / plastique, blanc

L 117, B 117, ET 26



5,5W 700lm 105x105



9 002759 991838

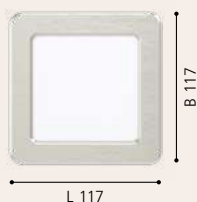

L 117



9 002759 991845



L 166, B 166, ET 26



10,5W 1350lm 155x155

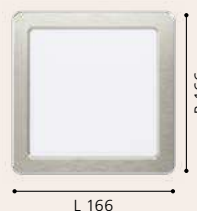

L 166

L 216, B 216, ET 26



16,5W 2000lm 205x205



9 002759 991852

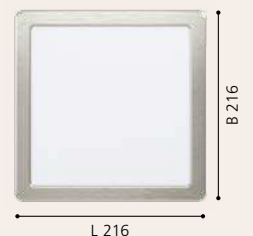

L 216





99187





99187

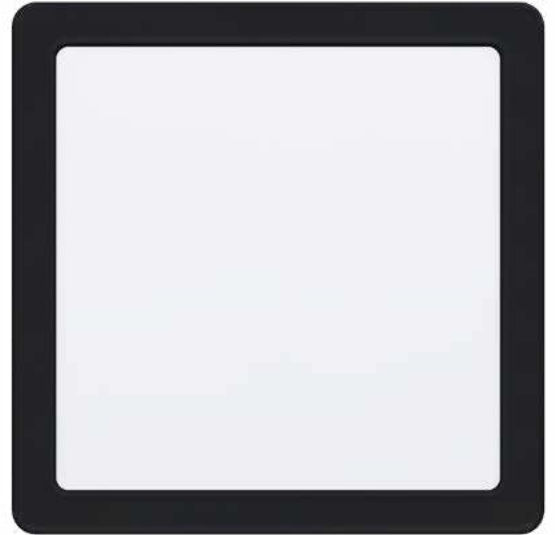

99189



99188



### 99187 FUEVA 5

recessed light; steel, black / plastic, white  
Einbauleuchte; Stahl, schwarz / Kunststoff, weiss  
luminaire encastrable; acier, noir / plastique, blanc

L 117, B 117, ET 26



5,5W 700lm 105x105



9 002759 991876



L 117



9 002759 991883



### 99188 FUEVA 5

recessed light; steel, black / plastic, white  
Einbauleuchte; Stahl, schwarz / Kunststoff, weiss  
luminaire encastrable; acier, noir / plastique, blanc

L 166, B 166, ET 26



10,5W 1350lm 155x155



L 166

### 99189 FUEVA 5

recessed light; steel, black / plastic, white  
Einbauleuchte; Stahl, schwarz / Kunststoff, weiss  
luminaire encastrable; acier, noir / plastique, blanc

L 216, B 216, ET 26



16,5W 2000lm 205x205



9 002759 991890



L 216

99191



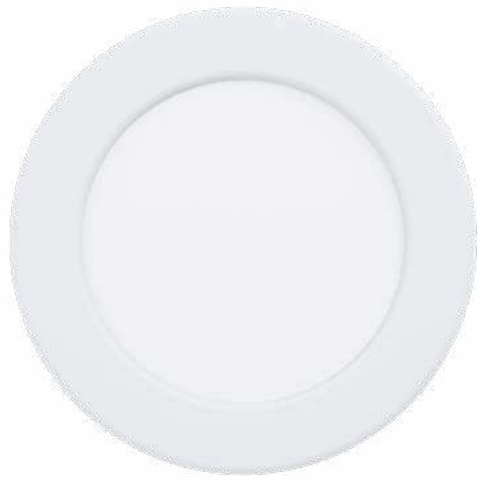

99191

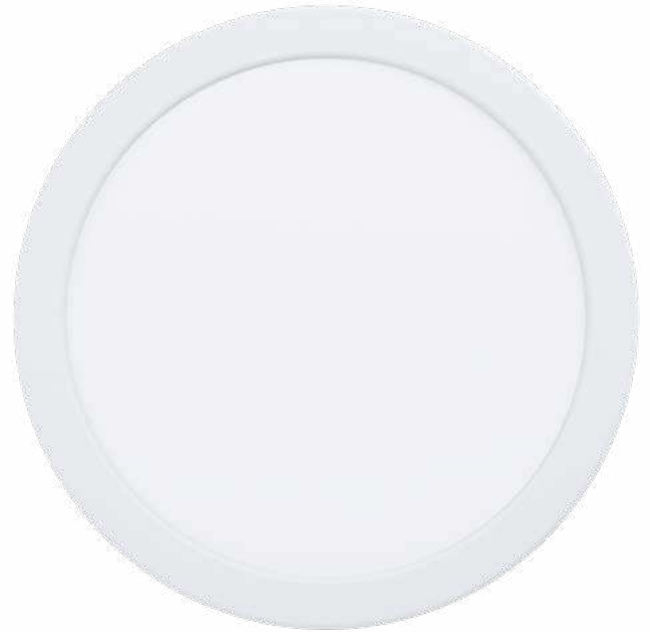

99193

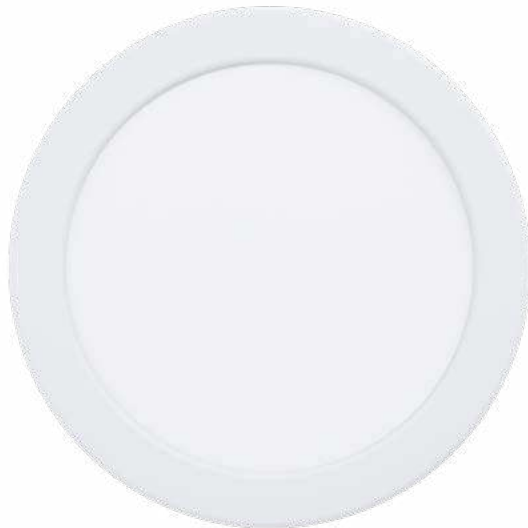

99192



### 99191 FUEVA 5

recessed light; steel, white / plastic, white  
Einbauleuchte; Stahl, weiss / Kunststoff, weiss  
luminaire encastrable; acier, blanc / plastique, blanc

Ø 117, ET 26



5,5W 650lm



Ø 105



9 002759 991913



Ø 117

### 99192 FUEVA 5

recessed light; steel, white / plastic, white  
Einbauleuchte; Stahl, weiss / Kunststoff, weiss  
luminaire encastrable; acier, blanc / plastique, blanc

Ø 166, ET 26



10,5W 1200lm



Ø 155



9 002759 991920



Ø 166

### 99193 FUEVA 5

recessed light; steel, white / plastic, white  
Einbauleuchte; Stahl, weiss / Kunststoff, weiss  
luminaire encastrable; acier, blanc / plastique, blanc

Ø 216, ET 26



16,5W 1800lm



Ø 205



9 002759 991937



Ø 216

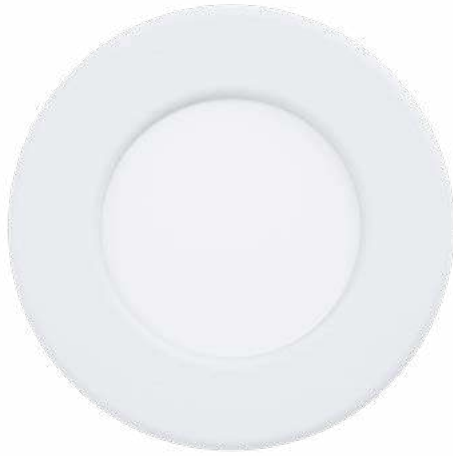

99202

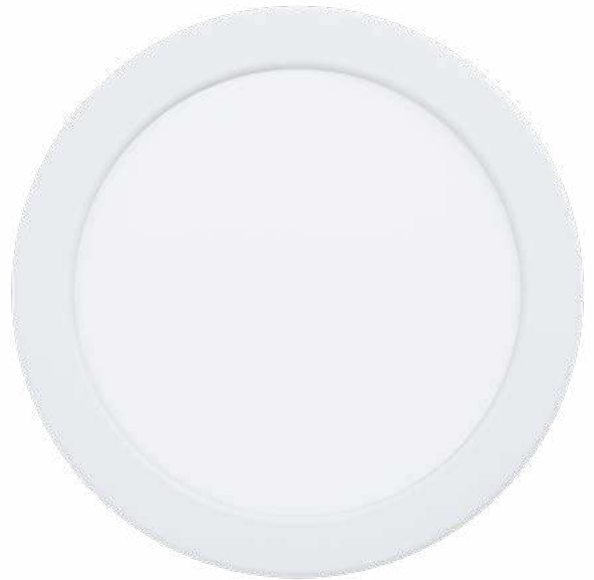

99203

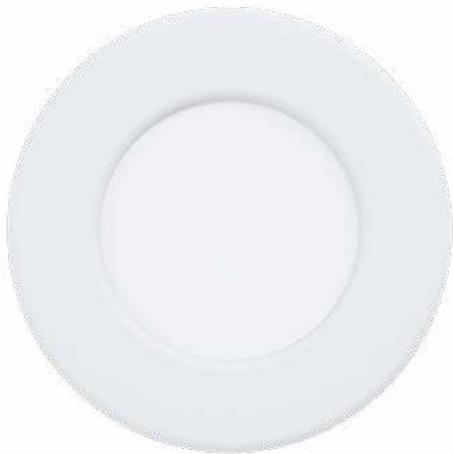

99206



### 99202 FUEVA 5

recessed light; steel, white / plastic, white  
Einbauleuchte; Stahl, weiss / Kunststoff, weiss  
luminaire encastrable; acier, blanc / plastique, blanc

Ø 86, ET 26



Ø 86

### 99206 FUEVA 5

recessed light; steel, white / plastic, white  
Einbauleuchte; Stahl, weiss / Kunststoff, weiss  
luminaire encastrable; acier, blanc / plastique, blanc

Ø 86, ET 26



Ø 86

### 99203 FUEVA 5

recessed light; steel, white / plastic, white  
Einbauleuchte; Stahl, weiss / Kunststoff, weiss  
luminaire encastrable; acier, blanc / plastique, blanc

Ø 166, ET 26



Ø 166



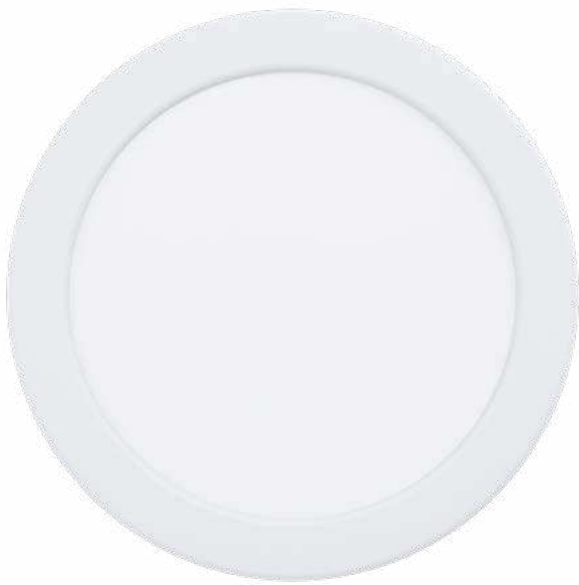

99207



IP44



### FUEVA 5

These luminaires are protected against splash water.

Diese Leuchten sind gegen Spritzwasser geschützt.

Les luminaires sont protégées contre les éclaboussures d'eau.

0 1 2 3

IP44		EU	X	X	✓	✓
		FR	X	X	X	✓

### 99207 FUEVA 5

recessed light; steel, white / plastic, white  
 Einbauleuchte; Stahl, weiss / Kunststoff, weiss  
 luminaire encastrable; acier, blanc / plastique, blanc

Ø 166, ET 26



Ø 166

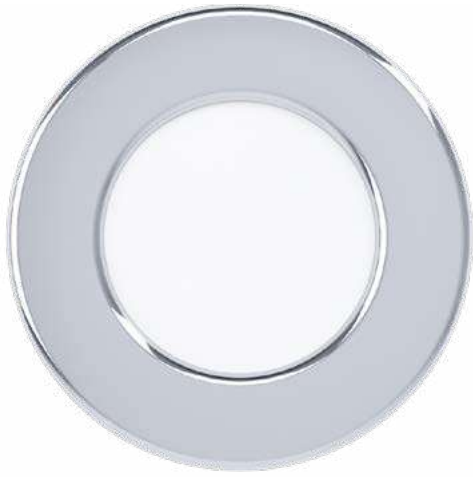

99204



99205

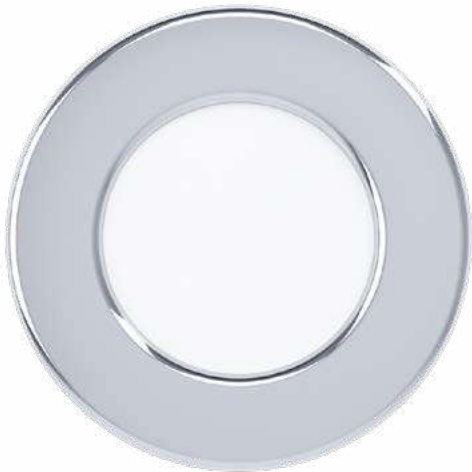

99208



### 99204 FUEVA 5

recessed light; steel, chrome / plastic, white  
Einbauleuchte; Stahl, chrom / Kunststoff, weiss  
luminaire encastrable; acier, chrome / plastique, blanc

Ø 86, ET 26



Ø 86

### 99208 FUEVA 5

recessed light; steel, chrome / plastic, white  
Einbauleuchte; Stahl, chrom / Kunststoff, weiss  
luminaire encastrable; acier, chrome / plastique, blanc

Ø 86, ET 26



Ø 86

### 99205 FUEVA 5

recessed light; steel, chrome / plastic, white  
Einbauleuchte; Stahl, chrom / Kunststoff, weiss  
luminaire encastrable; acier, chrome / plastique, blanc

Ø 166, ET 26



Ø 166



99209



IP44

### 99209 FUEVA 5

recessed light; steel, chrome / plastic, white  
Einbauleuchte; Stahl, chrom / Kunststoff, weiss  
luminaire encastrable; acier, chrome / plastique, blanc

Ø 166, ET 26

LED

10,5W

neutral  
WHITE

1350lm



Ø 155



IP44



9 002759 992095



Ø 166



99204



99211



IP44

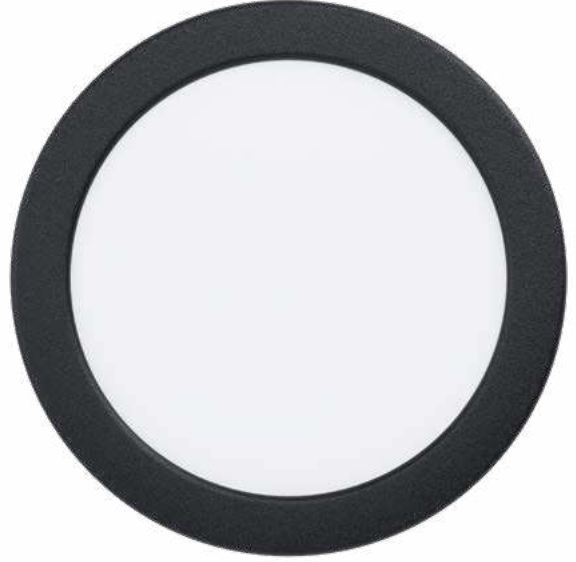

99212



IP44



99213



IP44

### 99211 FUEVA 5

recessed light; steel, black / plastic, white  
Einbauleuchte; Stahl, schwarz / Kunststoff, weiss  
luminaire encastrable; acier, noir / plastique, blanc

Ø 86, ET 26



2,7W 300lm Ø 75 IP44



9 002759 992118



Ø 86

### 99213 FUEVA 5

recessed light; steel, black / plastic, white  
Einbauleuchte; Stahl, schwarz / Kunststoff, weiss  
luminaire encastrable; acier, noir / plastique, blanc

Ø 86, ET 26



2,7W 360lm Ø 75 IP44



9 002759 992132



Ø 86

### 99212 FUEVA 5

recessed light; steel, black / plastic, white  
Einbauleuchte; Stahl, schwarz / Kunststoff, weiss  
luminaire encastrable; acier, noir / plastique, blanc

Ø 166, ET 26



10,5W 1200lm Ø 155 IP44



9 002759 992125



Ø 166



99214



IP44

### 99214 FUEVA 5

recessed light; steel, black / plastic, white  
Einbauleuchte; Stahl, schwarz / Kunststoff, weiss  
luminaire encastrable; acier, noir / plastique, blanc

Ø 166, ET 26

LED

10,5W

neutral  
WHITE

1350lm



Ø 155



IP44



9 002759 992149



Ø 166



99211



# RECESSED LUMINAIRES

## LOW VOLTAGE

### ADVANTAGES

- > SLIM DESIGN WITH MINIMAL INSTALLATION DEPTH, MAKING IT IDEAL FOR CEILING STRUCTURES WITH LITTLE SPACE
- > UNIFORM DISTRIBUTION OF LIGHT - IDEAL FOR ILLUMINATING SPACES AND SURFACES
- > LOW TEMPERATURE ENHANCES SAFETY
- > PLEASANT WARM WHITE LIGHT COLOR
- > LOW TEMPERATURE ENHANCES SAFETY
- > UP TO 80% POWER SAVINGS COMPARED TO INCANDESCENT LAMPS. EASY ON YOUR BUDGET AND THE ENVIRONMENT
- > IMPLIE CABLING THROUGH INTEGRATED TERMINAL CONNECTOR ON DRIVER

---

### VORTEILE

- > SCHLANKE BAUFORM MIT MINIMALER EINBAUTIEFE, DAHER IDEAL FÜR DECKEN-KONSTRUKTIONEN MIT WENIG PLATZ
- > HOMOGENE LICHTVERTEILUNG - IDEAL ZUR BELEUCHTUNG VON RÄUMEN UND FLÄCHEN
- > GERINGE WÄRMEENTWICKLUNG SORGT FÜR MEHR SICHERHEIT
- > BIS ZU 80% STROMERSPARNIS GEGENÜBER GLÜHLAMPEN, SCHONT IHR BUDGET UND DIE UMWELT
- > EINFACHE VERKABELUNG DURCH INTEGRIERTEN KLEMMANSCHLUSS AM TREIBER

---

### ADVANTAGES

- > CONCEPTION MINCE AVEC LA PROFONDEUR D'INSTALLATION MINIMALE, IDÉAL POUR LES STRUCTURES DE PLAFOND AVEC PEU D'ESPACE
- > DISTRIBUTION UNIFORME DE LA LUMIÈRE - IDÉAL POUR L'ILLUMINATION DES ESPACES ET SURFACES
- > FAIBLE CHALEUR AMÉLIORE LA SÉCURITÉ
- > JUSQU'À 80% D'ÉCONOMIES D'ÉNERGIE PAR RAPPORT AUX LAMPES À INCANDESCENCE, RÉDUIT VOTRE BUDGET ET PROTÈGE L'ENVIRONNEMENT
- > BUDGET AND THE ENVIRONMENT
- > CÂBLAGE SIMPLE VIA LE CONNECTEUR DE TERMINAL INTÉGRÉ SUR CONDUCTEUR



# OVERVIEW

**5** year warranty  
Jahre Garantie  
ans de garantie  
anni di garanzia  
años de garantía  
anos de garantía



RONZANO 1  
150



RONZANO 1  
150



FIOBBO  
152



FIOBBO  
152



FIOBBO  
152



FIOBBO  
153



CHANGO  
154





98521



98522



### 98521 RONZANO 1

recessed light; steel, white, silver  
 Einbauleuchte; Stahl, weiss, silber  
 luminaire encastrable; acier, blanc, argent

Ø 165, ET 50



5W

480lm

Ø 145

### 98522 RONZANO 1

recessed light; steel, black, silver  
 Einbauleuchte; Stahl, schwarz, silber  
 luminaire encastrable; acier, noir, argent

Ø 165, ET 50



5W

480lm

Ø 145



9 002759 985219

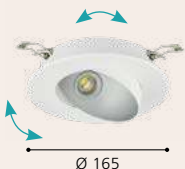

Ø 165



9 002759 985226

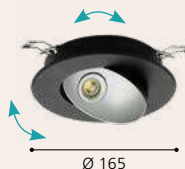

Ø 165





98522





97591



97592



97593



### 97591 FIOBBO

recessed light; steel, white / plastic with crystal effect, white  
Einbauleuchte; Stahl, weiss / Kunststoff m.Kristalleffekt, weiss  
luminaire encastrable; acier, blanc / plastique avec effet cristal, blanc

H 43, Ø 120, ET 35



5W 640lm

### 97592 FIOBBO

recessed light; steel, white / plastic with crystal effect, white  
Einbauleuchte; Stahl, weiss / Kunststoff m.Kristalleffekt, weiss  
luminaire encastrable; acier, blanc / plastique avec effet cristal, blanc

H 43, Ø 170, ET 35



10W 1100lm

### 97593 FIOBBO

recessed light; steel, white / plastic with crystal effect, white  
Einbauleuchte; Stahl, weiss / Kunststoff m.Kristalleffekt, weiss  
luminaire encastrable; acier, blanc / plastique avec effet cristal, blanc

H 50, Ø 225, ET 40



14W 1700lm



9 002759 975913



Ø 120



9 002759 975920



Ø 170



9 002759 975937



Ø 225



97594

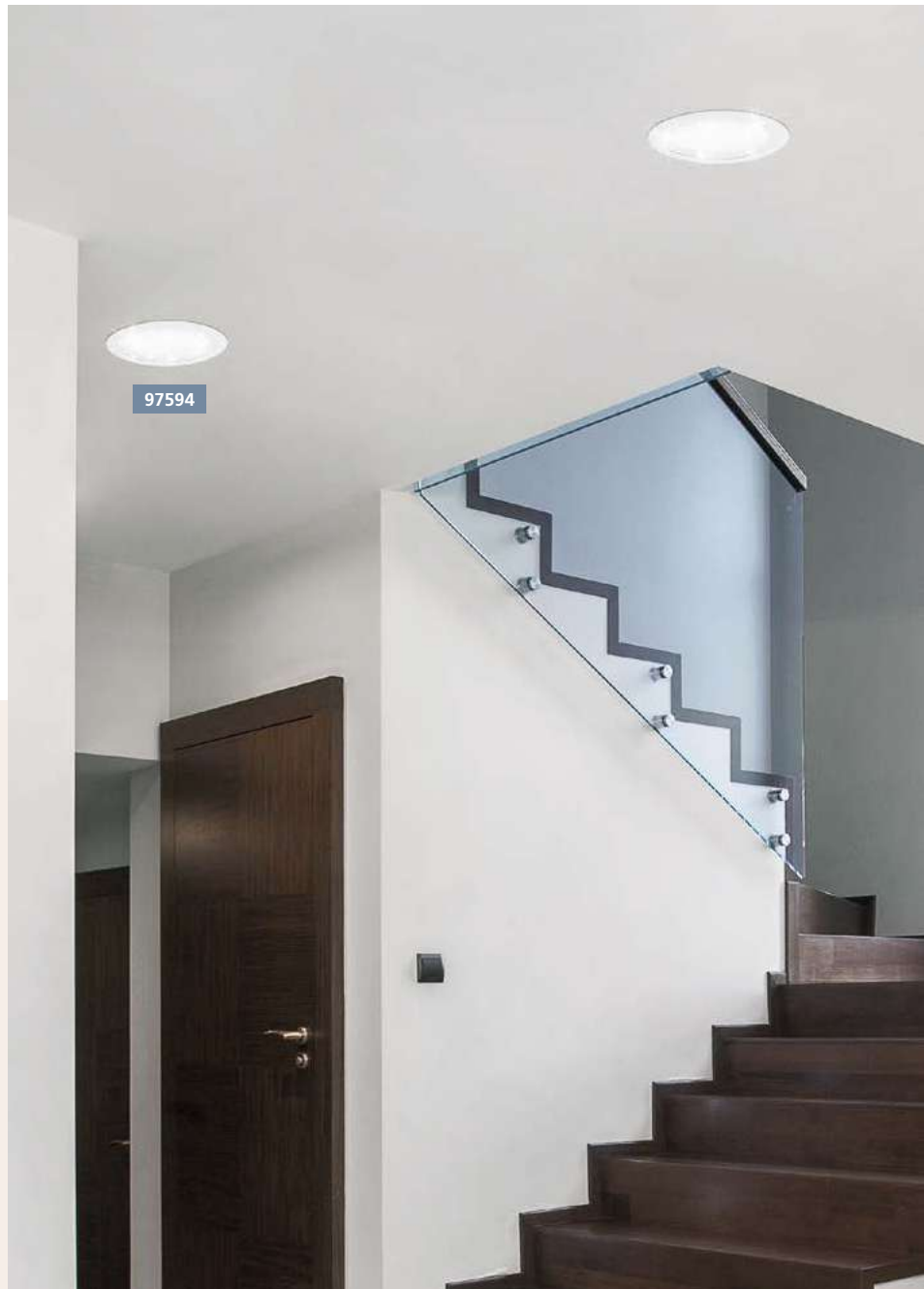

### 97594 FIOBBO

recessed light; steel, white / plastic with crystal effect, white  
Einbauleuchte; Stahl, weiss / Kunststoff m. Kristalleffekt, weiss  
luminaire encastrable; acier, blanc / plastique avec effet cristal, blanc

H 50, Ø 300, ET 40



21 W 2500 lm

Ø 280





97079



IP44

## CHANGO

- |                                 |                                   |                                    |
|---------------------------------|-----------------------------------|------------------------------------|
| > "Starry Sky" 3 Spot Set       | > "Sternenhimmel" 3 Spot Set      | > Ensemble 3 spots "Ciel étoilé"   |
| > Simple installation           | > Einfache Montage                | > Installation simple              |
| > Pre-assembled connecting box  | > Vorkonfigurierte Anschlußbox    | > Boîte de connexion pré-assemblée |
| > Plug & Play                   | > Plug & Play                     | > Branchez & jouez                 |
| > Desktop driver                | > Desktop Treiber                 | > Pilote de bureau                 |
| > Operable with 2 – 3 spotheads | > Verwendbar mit 2 – 3 Spotköpfen | > Utilisable avec 2 à 3 têtes      |
| incl. short-connector           | inkl. Verbinder                   | incl. connecteur court             |
| > Cable length = 2m             | > Kabellänge = 2m                 | > Longueur du câble = 2m           |
| > Cutout dimension = 16 mm      | > Ausschnitt Durchmesser = 16 mm  | > Cote de découpe = 16 mm          |

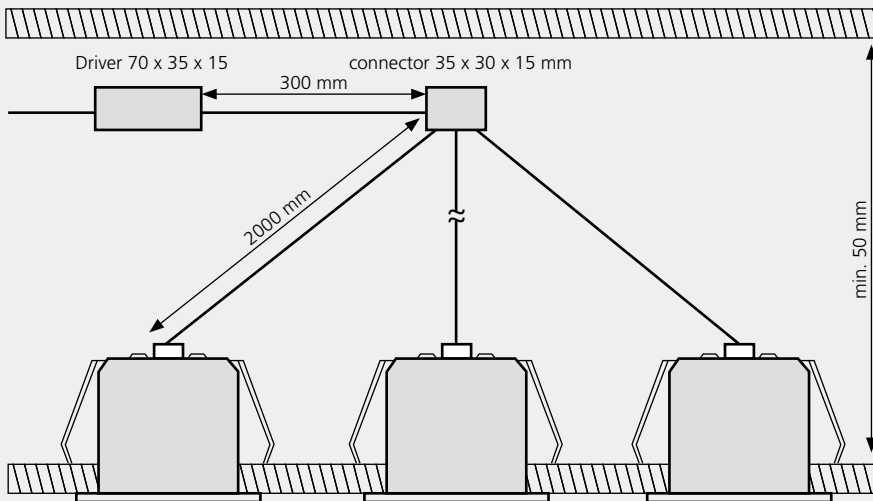

## 97079 CHANGO

recessed light; aluminium, white  
Einbauleuchte; Alu, weiss  
luminaire encastrable; aluminium, blanc

H 22, Ø 32, ET 25



3x 1W



3x 100lm



Ø 15



IP44



9 002759 970796







97079

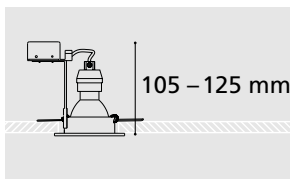

# RECESSED LUMINAIRES

## WITH BULBS

### ADVANTAGES

- > PROVEN TECHNOLOGY, CUSTOMIZED SOLUTIONS IN EVERY PRICE CATEGORY
- > DEPENDING ON THE SELECTED LAMPS APPROPRIATE FOR ILLUMINATING AREAS AND ROOMS OR FOR ACCENT LIGHTING
- > GREAT COLORS AND SHAPES
- > UP TO 80% POWER SAVINGS COMPARED TO INCANDESCENT LAMPS, EASY ON YOUR BUDGET AND THE ENVIRONMENT
- > LAMP REPLACEABLE FROM THE BOTTOM

---

### VORTEILE

- > BEWÄHRTE TECHNOLOGIE, INDIVIDUELLE LÖSUNGEN IN JEDER PREISKLASSE
- > JE NACH EINGESETZTEM LEUCHTMITTEL ZUR BELEUCHTUNG VON FLÄCHEN UND RÄUMEN ODER ZUR AKZENTBELEUCHTUNG
- > GROSSE FARBEN- UND FORMENVIELFALT
- > BIS ZU 80% STROMERSPARNIS GEGENÜBER GLÜHLAMPEN, SCHONT IHR BUDGET UND DIE UMWELT
- > LEUCHTMITTEL VON UNTEN TAUSCHBAR

---

### ADVANTAGES

- > UNE TECHNOLOGIE ÉPROUVÉE, SOLUTIONS INDIVIDUELLES DANS CHAQUE CATÉGORIE DE PRIX
- > SELON LES LAMPES CHOISIES APTE À ÉCLAIRER DES SURFACES ET DES CHAMBRES OU POUR L'ÉCLAIRAGE ACCENTUEL
- > COULEURS ET FORMES FANTASTIQUES
- > JUSQU'À 80% D'ÉCONOMIES D'ÉNERGIE PAR RAPPORT AUX LAMPES À INCANDESCENCE, RÉDUIT VOTRE BUDGET ET PROTÈGE L'ENVIRONNEMENT
- > LAMPE REMPLAÇABLE PAR LE BAS

# OVERVIEW

**5** year warranty  
 Jahre Garantie  
 ans de garantie  
 anni di garanzia  
 años de garantía  
 anos de garantia

							
SALUZZO 158	SALUZZO 158	AREITIO 160	AREITIO 160	AREITIO 160	AREITIO 161	PENETO 162	PENETO 162
							
PENETO 162	PENETO 163	PENETO 163	PENETO 163	PENETO 164	PENETO 164	PENETO 164	PENETO 165
							
PENETO 165	PENETO 165	PENETO 166	PENETO 166	TEDO 168	TEDO 168	TEDO 168	TEDO 169
							
TEDO 169	TEDO 1 170	TEDO 1 170	TEDO 170	TEDO 1 172	TEDO 1 173	TEDO 173	TEDO 173





99061



99062

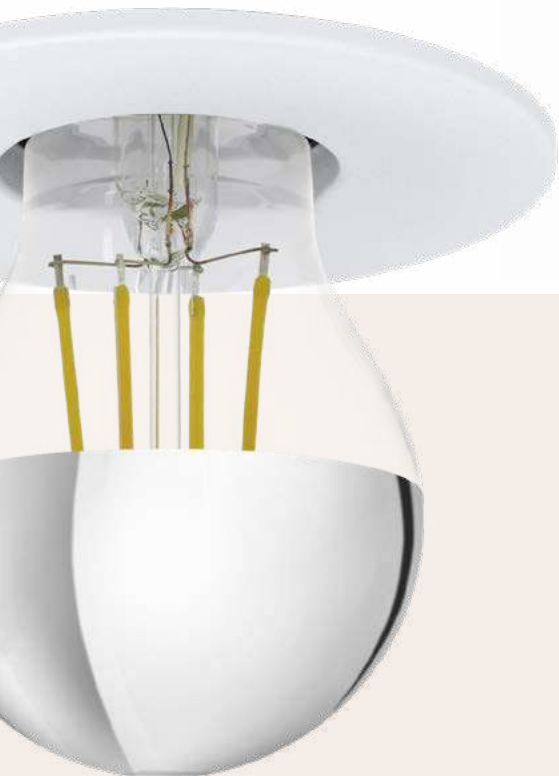

### 99061 SALUZZO

recessed light; steel, black  
Einbauleuchte; Stahl, schwarz  
luminaire encastrable; acier, noir

H 3, Ø 90



E27 1x 40W Ø 68

### 99062 SALUZZO

recessed light; steel, white  
Einbauleuchte; Stahl, weiss  
luminaire encastrable; acier, blanc

H 3, Ø 90



E27 1x 40W Ø 68



9 002759 990619



Ø 90



9 002759 990626



Ø 90





99061





98638



98639



98636



### 98638 AREITIO

recessed light; aluminium, brushed aluminium  
Einbauleuchte; Alu, alu-gebürstet  
luminaire encastrable; aluminium, aluminium brossé

Ø 110



### 98639 AREITIO

recessed light; aluminium, brushed aluminium  
Einbauleuchte; Alu, alu-gebürstet  
luminaire encastrable; aluminium, aluminium brossé

Ø 110



### 98636 AREITIO

recessed light; aluminium, brushed aluminium  
Einbauleuchte; Alu, alu-gebürstet  
luminaire encastrable; aluminium, aluminium brossé

L 95, B 95, ET 115

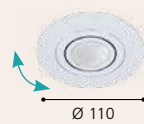
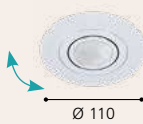





98637

LED



98636

**98637 AREITIO**

recessed light; aluminium, brushed aluminium  
 Einbauleuchte; Alu, alu-gebürstet  
 luminaire encastrable; aluminium, aluminium brossé

L 95, B 95, ET 115

-  GU10
-  3x 5W
-  warm  
WHITE  
3x  
400lm
-  Ø75
- 





98644

LED



98645

LED



98646

LED

### 98644 PENETO

recessed light; steel, white  
 Einbauleuchte; Stahl, weiss  
 luminaire encastrable; acier, blanc

### 98645 PENETO

recessed light; steel, satin nickel  
 Einbauleuchte; Stahl, nickel-matt  
 luminaire encastrable; acier, nickel mat

### 98646 PENETO

recessed light; steel, chrome  
 Einbauleuchte; Stahl, chrom  
 luminaire encastrable; acier, chrome

Ø 78, ET 115



Ø 78, ET 115



Ø 78, ET 115



9 002759 986445



Ø 78



9 002759 986452



Ø 78



9 002759 986469



Ø 78





94235

LED



94236

LED



94237

LED

### 94235 PENETO

recessed light; steel, white  
 Einbauleuchte; Stahl, weiss  
 luminaire encastrable; acier, blanc

### 94237 PENETO

recessed light; steel, satin nickel  
 Einbauleuchte; Stahl, nickel-matt  
 luminaire encastrable; acier, nickel mat

### 94236 PENETO

recessed light; steel, chrome  
 Einbauleuchte; Stahl, chrom  
 luminaire encastrable; acier, chrome

Ø 78, ET 115

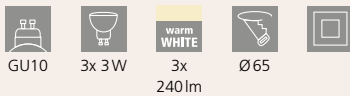

Ø 78, ET 115



Ø 78, ET 115





94239

LED



94242

LED



94406

LED

### 94239 PENETO

recessed light; steel, white  
Einbauleuchte; Stahl, weiss  
luminaire encastrable; acier, blanc

### 94406 PENETO

recessed light; steel, white  
Einbauleuchte; Stahl, weiss  
luminaire encastrable; acier, blanc

### 94242 PENETO

recessed light; steel, satin nickel  
Einbauleuchte; Stahl, nickel-matt  
luminaire encastrable; acier, nickel mat

Ø 87, ET 115



Ø 87, ET 115



Ø 87, ET 115

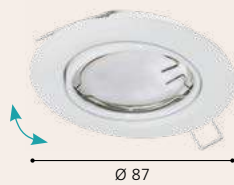
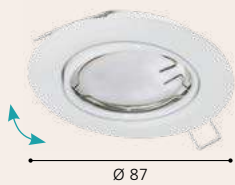



94408

LED



94407

LED



94241

LED

### 94408 PENETO

recessed light; steel, satin nickel  
Einbauleuchte; Stahl, nickel-matt  
luminaire encastrable; acier, nickel mat

### 94241 PENETO

recessed light; steel, chrome  
Einbauleuchte; Stahl, chrom  
luminaire encastrable; acier, chrome

### 94407 PENETO

recessed light; steel, chrome  
Einbauleuchte; Stahl, chrom  
luminaire encastrable; acier, chrome

Ø 87, ET 115



Ø 87, ET 115



Ø 87, ET 115

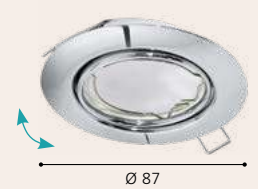
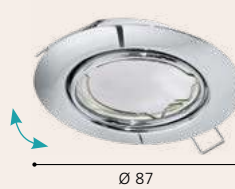





94243

LED



94262

LED

### 94243 PENETO

recessed light; steel, bronzed  
 Einbauleuchte; Stahl, brüniert  
 luminaire encastrable; acier, bruni

### 94262 PENETO

recessed light; steel, white  
 Einbauleuchte; Stahl, weiss  
 luminaire encastrable; acier, blanc

Ø 87, ET 115



L 87, B 87, ET 115





94243



31682



31688



31683



### 31682 TEDO

recessed light; cast aluminium, white  
Einbauleuchte; Aluguss, weiss  
luminaire encastrable; fonte d'aluminium, blanc

Ø 80, ET 115



### 31683 TEDO

recessed light; cast aluminium, white  
Einbauleuchte; Aluguss, weiss  
luminaire encastrable; fonte d'aluminium, blanc

Ø 80, ET 115



### 31688 TEDO

recessed light; cast aluminium, satin nickel  
Einbauleuchte; Aluguss, nickel-matt  
luminaire encastrable; fonte d'aluminium, nickel mat

Ø 80, ET 115



9 002759 316822



Ø 80



9 002759 316839



Ø 80



9 002759 316884



Ø 80





31689

LED



95362

LED

### 31689 TEDO

recessed light; cast aluminium, satin nickel  
 Einbauleuchte; Aluguss, nickel-matt  
 luminaire encastrable; fonte d'aluminium, nickel mat

### 95362 TEDO

recessed light; cast aluminium, chrome  
 Einbauleuchte; Aluguss, chrom  
 luminaire encastrable; fonte d'aluminium, chrome

Ø 80, ET 115



Ø 80, ET 115





98641

LED



98642

LED



98643

LED

### 98641 TEDO 1

recessed light; cast aluminium, white  
 Einbauleuchte; Aluguss, weiss  
 luminaire encastrable; fonte d'aluminium, blanc

Ø 80, ET 115



### 98642 TEDO 1

recessed light; cast aluminium, satin nickel  
 Einbauleuchte; Aluguss, nickel-matt  
 luminaire encastrable; fonte d'aluminium, nickel mat

Ø 80, ET 115



### 98643 TEDO

recessed light; cast aluminium, chrome  
 Einbauleuchte; Aluguss, chrom  
 luminaire encastrable; fonte d'aluminium, chrome

Ø 80, ET 115



9 002759 986414



Ø 80



9 002759 986421



Ø 80



9 002759 986438



Ø 80







98641





### DIMMING WITHOUT A DIMMER?

There's no need for a dimmer anymore, and no need to spend money on an expensive modern LED-capable one.

The luminaire automatically switches to the next dimming level when it is switched off and on again within 3 seconds. If the luminaire stays off for more than 3 seconds, the next activation will automatically return to full lighting. You don't need to switch through all levels the next day.

#### Note

Our step dimming illuminants are only dimmable via the on/off switch. Operation with a conventional dimmer is not intended and may cause permanent damage to the electronics. The illuminants are therefore marked as "not dimmable" according to European regulations.

### DIMMEN OHNE DIMMER?

Kein Dimmer mehr notwendig – Sie ersparen sich somit hohe Anschaffungskosten für einen modernen LED-fähigen Dimmer.

Wird die Leuchte innerhalb von 3 Sekunden aus- und wieder eingeschaltet, wechselt es automatisch in die nächste Dimmstufe. Bleibt die Leuchte länger als 3 Sekunden ausgeschaltet, stehen Ihnen beim nächsten Einschalten automatisch wieder 100 % Leuchtkraft zur Verfügung – Sie ersparen sich also das mühsame Durchschalten am nächsten Tag.

#### Hinweis

Unsere Stepdimming-Leuchtmittel sind nur über Ein-/Ausschalter dimmbar – der Betrieb mit konventionellen Dimmern ist nicht vorgesehen und könnte die Elektronik dauerhaft beschädigen. Die Leuchtmittel werden daher gemäß europäischer Vorschriften als „nicht dimmbar“ gekennzeichnet.

### GRADUER SANS GRADUATEUR ?

Aucun gradateur n'est nécessaire – Vous vous épargnez ainsi les coûts d'acquisition élevés pour un gradateur DEL moderne.

Lorsque le luminaire est éteint, puis rallumé en l'espace de 3 secondes, il passe automatiquement au prochain niveau de graduation. Lorsque le luminaire reste éteint plus de 3 secondes, vous aurez à nouveau automatiquement 100 % de la force lumineuse lors du prochain allumage – Vous vous épargnez alors la commutation fatigante le lendemain.

#### Remarque

Nos ampoules à graduation par niveau sont graduable uniquement par l'interrupteur marche / arrêt – le service avec un gradateur conventionnel n'est pas prévu et pourrait endommager l'électronique à long terme. Les ampoules sont alors marquées par « non graduable », selon les réglementations européenne.



### 95357 TEDO 1

recessed light; cast aluminium, white  
Einbauleuchte; Aluguss, weiss  
luminaire encastrable; fonte d'aluminium, blanc

Ø 80, ET 115

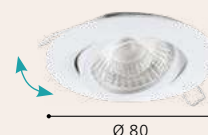



96616



96617

### 95359 TEDO 1

recessed light; cast aluminium, satin nickel  
 Einbauleuchte; Aluguss, nickel-matt  
 luminaire encastrable; fonte d'aluminium, nickel mat

Ø 80, ET 115



### 96616 TEDO

recessed light; cast aluminium, white  
 Einbauleuchte; Aluguss, weiss  
 luminaire encastrable; fonte d'aluminium, blanc

Ø 80, ET 115

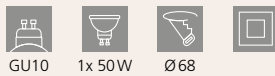

### 96617 TEDO

recessed light; cast aluminium, satin nickel  
 Einbauleuchte; Aluguss, nickel-matt  
 luminaire encastrable; fonte d'aluminium, nickel mat

Ø 80, ET 115

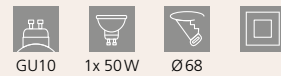

9 002759 953591



Ø 80



9 002759 966164



Ø 80



9 002759 966171



Ø 80

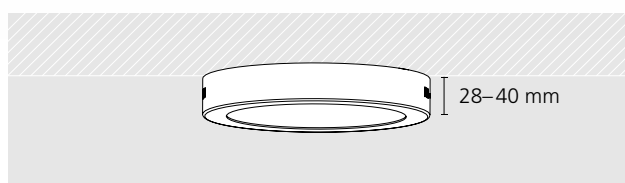

# SURFACE LUMINAIRES

## FUEVA

### ADVANTAGES

- > SLIM DESIGN WITH LOW SURFACE HEIGHT (28 TO 40 MM)
- > UNIFORM DISTRIBUTION OF INDIRECT LIGHT - IDEAL FOR ILLUMINATING SPACES AND SURFACES
- > LOW TEMPERATURE ENHANCES SAFETY
- > UP TO 80% POWER SAVINGS COMPARED TO INCANDESCENT LAMPS, EASY ON YOUR BUDGET AND THE ENVIRONMENT

---

### VORTEILE

- > SCHLANKE BAUFORM MIT GERINGER AUFBAUHÖHE (28 BIS 40 MM)
- > HOMOGENES, INDIREKTES LICHT - IDEAL ZUR BELEUCHTUNG VON RÄUMEN UND FLÄCHEN
- > GERINGE WÄRMEENTWICKLUNG SORGT FÜR MEHR SICHERHEIT
- > BIS ZU 80% STROMERSPARNIS GEGENÜBER GLÜHLAMPEN, SCHONT IHR BUDGET UND DIE UMWELT

---

### ADVANTAGES

- > CONCEPTION MINCE AVEC LA HAUTEUR DE SAILIE MINIMALE (DE 28 À 40 MM)
- > LA DISTRIBUTION UNIFORME DE LA LUMIÈRE INDIRECTE - IDÉAL POUR LES ESPACES ET LES SURFACES ÉCLAIRANTES
- > FAIBLE CHALEUR AMÉLIORE LA SÉCURITÉ
- > JUSQU'À 80% D'ÉCONOMIES D'ÉNERGIE PAR RAPPORT AUX LAMPES À INCANDESCENCE, RÉDUIT VOTRE BUDGET ET PROTÈGE L'ENVIRONNEMENT

# OVERVIEW

**5** year warranty  
 Jahre Garantie  
 ans de garantie  
 anni di garanzia  
 años de garantía  
 anos de garantia



FUEVA 5  
177



FUEVA 5  
177



FUEVA 5  
178



FUEVA 5  
178



FUEVA 5  
179



FUEVA 5  
179



FUEVA 5  
180



FUEVA 5  
180



FUEVA 5  
181



FUEVA 5  
181



FUEVA 5  
182



FUEVA 5  
182



FUEVA 5  
184



FUEVA 5  
184



FUEVA 5  
185



FUEVA 5  
185



FUEVA 5  
186



FUEVA 5  
186



FUEVA 5  
188



FUEVA 5  
188



FUEVA 5  
189



FUEVA 5  
190



FUEVA 5  
192



FUEVA 5  
193



FUEVA 5  
194



FUEVA 5  
196



FUEVA 1  
198



FUEVA 1  
199



FUEVA 1  
200



FUEVA 1  
201



FUEVA 1  
202



FUEVA 1  
203



FUEVA 1  
203



FUEVA 1  
204



FUEVA 1  
204



FUEVA 1  
205



# THE NEW FUEVA 5

## FEATURES



### FEATURES

Quick Connector  
Schnellverbinder  
Connecteur rapide

FLICKER FREE  
FLICKER FREI  
FLICKER FREE

### DESIGN

Flat design from originally 40 mm  
high to **28** mm high/  
flaches Design von ursprünglich 40 mm  
Höhe auf **28** mm Höhe/  
Design plat de 40 mm de haut à  
**28** mm de haut

narrow frame from 21 mm to **15** mm  
schmaler Rahmen von 21 mm auf **15** mm  
cadre étroit de 21 mm vers **15** mm

modern appearance  
moderneres Erscheinungsbild  
apparence plus moderne

SEE PAGE 177 - 197  
SIEHE SEITE 177 - 197  
VOIR PAGE 177 - 197



99215



99217



99216



### 99215 FUEVA 5

surface-mounted light; steel, white / plastic, white  
Aufbauleuchte; Stahl, weiss / Kunststoff, weiss  
luminaire en saillie; acier, blanc / plastique, blanc

H 28, Ø 160



10,5W 1200lm

### 99216 FUEVA 5

surface-mounted light; steel, white / plastic, white  
Aufbauleuchte; Stahl, weiss / Kunststoff, weiss  
luminaire en saillie; acier, blanc / plastique, blanc

H 28, Ø 210



16,5W 1800lm

### 99217 FUEVA 5

surface-mounted light; steel, white / plastic, white  
Aufbauleuchte; Stahl, weiss / Kunststoff, weiss  
luminaire en saillie; acier, blanc / plastique, blanc

H 28, Ø 285



20W 2300lm



9 002759 992156



Ø 160



9 002759 992163



Ø 210



9 002759 992170



Ø 285



99218



99221



99219



### 99218 FUEVA 5

surface-mounted light; steel, satin nickel / plastic, white  
Aufbauleuchte; Stahl, nickel-matt / Kunststoff, weiss  
luminaire en saillie; acier, nickel mat / plastique, blanc

H 28, Ø 160



10,5W 1200lm

### 99219 FUEVA 5

surface-mounted light; steel, satin nickel / plastic, white  
Aufbauleuchte; Stahl, nickel-matt / Kunststoff, weiss  
luminaire en saillie; acier, nickel mat / plastique, blanc

H 28, Ø 210



16,5W 1800lm

### 99221 FUEVA 5

surface-mounted light; steel, satin nickel / plastic, white  
Aufbauleuchte; Stahl, nickel-matt / Kunststoff, weiss  
luminaire en saillie; acier, nickel mat / plastique, blanc

H 28, Ø 285



20W 2300lm



9 002759 992187



Ø 160



9 002759 992194



Ø 210



9 002759 992217



Ø 285



99222



99224



99223



### 99222 FUEVA 5

surface-mounted light; steel, black / plastic, white  
Aufbauleuchte; Stahl, schwarz / Kunststoff, weiss  
luminaire en saillie; acier, noir / plastique, blanc

H 28, Ø 160



10,5W 1200lm

### 99223 FUEVA 5

surface-mounted light; steel, black / plastic, white  
Aufbauleuchte; Stahl, schwarz / Kunststoff, weiss  
luminaire en saillie; acier, noir / plastique, blanc

H 28, Ø 210



16,5W 1800lm

### 99224 FUEVA 5

surface-mounted light; steel, black / plastic, white  
Aufbauleuchte; Stahl, schwarz / Kunststoff, weiss  
luminaire en saillie; acier, noir / plastique, blanc

H 28, Ø 285



20W 2300lm



9 002759 992224



Ø 160



9 002759 992231



Ø 210



9 002759 992248



Ø 285



99225



99227



99226



### 99225 FUEVA 5

surface-mounted light; steel, white / plastic, white  
Aufbauleuchte; Stahl, weiss / Kunststoff, weiss  
luminaire en saillie; acier, blanc / plastique, blanc

H 28, Ø 160



10,5W 1350lm

### 99226 FUEVA 5

surface-mounted light; steel, white / plastic, white  
Aufbauleuchte; Stahl, weiss / Kunststoff, weiss  
luminaire en saillie; acier, blanc / plastique, blanc

H 28, Ø 210



16,5W 2000lm

### 99227 FUEVA 5

surface-mounted light; steel, white / plastic, white  
Aufbauleuchte; Stahl, weiss / Kunststoff, weiss  
luminaire en saillie; acier, blanc / plastique, blanc

H 28, Ø 285



20W 2500lm



9 002759 992255



Ø 160



9 002759 992262



Ø 210



9 002759 992279



Ø 285





99228



99232



99229



### 99228 FUEVA 5

surface-mounted light; steel, satin nickel / plastic, white  
Aufbauleuchte; Stahl, nickel-matt / Kunststoff, weiss  
luminaire en saillie; acier, nickel mat / plastique, blanc

H 28, Ø 160



10,5W 1350lm

### 99229 FUEVA 5

surface-mounted light; steel, satin nickel / plastic, white  
Aufbauleuchte; Stahl, nickel-matt / Kunststoff, weiss  
luminaire en saillie; acier, nickel mat / plastique, blanc

H 28, Ø 210



16,5W 2000lm

### 99232 FUEVA 5

surface-mounted light; steel, satin nickel / plastic, white  
Aufbauleuchte; Stahl, nickel-matt / Kunststoff, weiss  
luminaire en saillie; acier, nickel mat / plastique, blanc

H 28, Ø 285



20W 2500lm



9 002759 992286



Ø 160



9 002759 992293



Ø 210



9 002759 992323



Ø 285



99233



99235



99234



### 99233 FUEVA 5

surface-mounted light; steel, black / plastic, white  
Aufbauleuchte; Stahl, schwarz / Kunststoff, weiss  
luminaire en saillie; acier, noir / plastique, blanc

H 28, Ø 160



10,5W 1350lm

### 99234 FUEVA 5

surface-mounted light; steel, black / plastic, white  
Aufbauleuchte; Stahl, schwarz / Kunststoff, weiss  
luminaire en saillie; acier, noir / plastique, blanc

H 28, Ø 210



16,5W 2000lm

### 99235 FUEVA 5

surface-mounted light; steel, black / plastic, white  
Aufbauleuchte; Stahl, schwarz / Kunststoff, weiss  
luminaire en saillie; acier, noir / plastique, blanc

H 28, Ø 285



20W 2500lm



9 002759 992330



Ø 160



9 002759 992347



Ø 210



9 002759 992354



Ø 285



99235



99236

LED



99238

LED



99237

LED

### 99236 FUEVA 5

surface-mounted light; steel, white / plastic, white  
Aufbauleuchte; Stahl, weiss / Kunststoff, weiss  
luminaire en saillie; acier, blanc / plastique, blanc

L 160, B 160, H 28



10,5W 1200lm

### 99237 FUEVA 5

surface-mounted light; steel, white / plastic, white  
Aufbauleuchte; Stahl, weiss / Kunststoff, weiss  
luminaire en saillie; acier, blanc / plastique, blanc

L 210, B 210, H 28



16,5W 1800lm

### 99238 FUEVA 5

surface-mounted light; steel, white / plastic, white  
Aufbauleuchte; Stahl, weiss / Kunststoff, weiss  
luminaire en saillie; acier, blanc / plastique, blanc

L 285, B 285, H 28



20W 2300lm



9 002759 992361

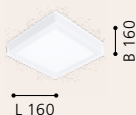

L 160



9 002759 992378



L 210



9 002759 992385



L 285



99239

LED



99242

LED



99241

LED

### 99239 FUEVA 5

surface-mounted light; steel, satin nickel / plastic, white  
Aufbauleuchte; Stahl, nickel-matt / Kunststoff, weiss  
luminaire en saillie; acier, nickel mat / plastique, blanc

L 160, B 160, H 28



10,5W 1200lm

### 99241 FUEVA 5

surface-mounted light; steel, satin nickel / plastic, white  
Aufbauleuchte; Stahl, nickel-matt / Kunststoff, weiss  
luminaire en saillie; acier, nickel mat / plastique, blanc

L 210, B 210, H 28



16,5W 1800lm

### 99242 FUEVA 5

surface-mounted light; steel, satin nickel / plastic, white  
Aufbauleuchte; Stahl, nickel-matt / Kunststoff, weiss  
luminaire en saillie; acier, nickel mat / plastique, blanc

L 285, B 285, H 28



20W 2300lm



9 002759 992392

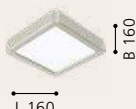

L 160



9 002759 992415



L 210



9 002759 992422



L 285



99243

LED



99245

LED



99244

LED

### 99243 FUEVA 5

surface-mounted light; steel, black / plastic, white  
Aufbauleuchte; Stahl, schwarz / Kunststoff, weiss  
luminaire en saillie; acier, noir / plastique, blanc

L 160, B 160, H 28



10,5W 1200lm

### 99244 FUEVA 5

surface-mounted light; steel, black / plastic, white  
Aufbauleuchte; Stahl, schwarz / Kunststoff, weiss  
luminaire en saillie; acier, noir / plastique, blanc

L 210, B 210, H 28



16,5W 1800lm

### 99245 FUEVA 5

surface-mounted light; steel, black / plastic, white  
Aufbauleuchte; Stahl, schwarz / Kunststoff, weiss  
luminaire en saillie; acier, noir / plastique, blanc

L 285, B 285, H 28



20W 2300lm



9 002759 992439



L 160



9 002759 992446

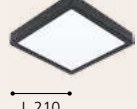

L 210



9 002759 992453



L 285





99245





99246



99248



99247



### 99246 FUEVA 5

surface-mounted light; steel, white / plastic, white  
Aufbauleuchte; Stahl, weiss / Kunststoff, weiss  
luminaire en saillie; acier, blanc / plastique, blanc

L 160, B 160, H 28



10,5W 1350lm

### 99247 FUEVA 5

surface-mounted light; steel, white / plastic, white  
Aufbauleuchte; Stahl, weiss / Kunststoff, weiss  
luminaire en saillie; acier, blanc / plastique, blanc

L 210, B 210, H 28



16,5W 2000lm

### 99248 FUEVA 5

surface-mounted light; steel, white / plastic, white  
Aufbauleuchte; Stahl, weiss / Kunststoff, weiss  
luminaire en saillie; acier, blanc / plastique, blanc

L 285, B 285, H 28



20W 2500lm



9 002759 992460

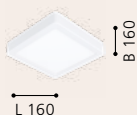

L 160



9 002759 992477



L 210



9 002759 992484



L 285



99252



99254



99253



### 99252 FUEVA 5

surface-mounted light; steel, satin nickel / plastic, white  
Aufbauleuchte; Stahl, nickel-matt / Kunststoff, weiss  
luminaire en saillie; acier, nickel mat / plastique, blanc

L 160, B 160, H 28



10,5W 1350lm

### 99253 FUEVA 5

surface-mounted light; steel, satin nickel / plastic, white  
Aufbauleuchte; Stahl, nickel-matt / Kunststoff, weiss  
luminaire en saillie; acier, nickel mat / plastique, blanc

L 210, B 210, H 28



16,5W 2000lm

### 99254 FUEVA 5

surface-mounted light; steel, satin nickel / plastic, white  
Aufbauleuchte; Stahl, nickel-matt / Kunststoff, weiss  
luminaire en saillie; acier, nickel mat / plastique, blanc

L 285, B 285, H 28



20W 2500lm



9 002759 992521

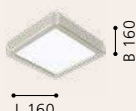

L 160



9 002759 992538

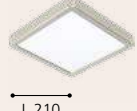

L 210



9 002759 992545



L 285



99255

LED



99257

LED



99256

LED

### 99255 FUEVA 5

surface-mounted light; steel, black / plastic, white  
Aufbauleuchte; Stahl, schwarz / Kunststoff, weiss  
luminaire en saillie; acier, noir / plastique, blanc

L 160, B 160, H 28



10,5W 1350lm

### 99256 FUEVA 5

surface-mounted light; steel, black / plastic, white  
Aufbauleuchte; Stahl, schwarz / Kunststoff, weiss  
luminaire en saillie; acier, noir / plastique, blanc

L 210, B 210, H 28



16,5W 2000lm

### 99257 FUEVA 5

surface-mounted light; steel, black / plastic, white  
Aufbauleuchte; Stahl, schwarz / Kunststoff, weiss  
luminaire en saillie; acier, noir / plastique, blanc

L 285, B 285, H 28



20W 2500lm



9 002759 992552



L 160



9 002759 992569



L 210



9 002759 992576



L 285



99257





99258



99263



99259



### 99258 FUEVA 5

surface-mounted light; steel, white / plastic, white  
Aufbauleuchte; Stahl, weiss / Kunststoff, weiss  
luminaire en saillie; acier, blanc / plastique, blanc

H 28, Ø 210



16,5W 1800lm

### 99259 FUEVA 5

surface-mounted light; steel, white / plastic, white  
Aufbauleuchte; Stahl, weiss / Kunststoff, weiss  
luminaire en saillie; acier, blanc / plastique, blanc

H 28, Ø 285



20W 2300lm

### 99263 FUEVA 5

surface-mounted light; steel, black / plastic, white  
Aufbauleuchte; Stahl, schwarz / Kunststoff, weiss  
luminaire en saillie; acier, noir / plastique, blanc

H 28, Ø 210



16,5W 1800lm



9 002759 992583



Ø 210



9 002759 992590



Ø 285



9 002759 992637



Ø 210





99264



99263

### 99264 FUEVA 5

surface-mounted light; steel, black / plastic, white  
Aufbauleuchte; Stahl, schwarz / Kunststoff, weiss  
luminaire en saillie; acier, noir / plastique, blanc

H 28, Ø 285

LED

20W

warm  
WHITE

2300lm



9 002759 992644



Ø 285



99265



IP44



99266



IP44

### 99265 FUEVA 5

surface-mounted light; steel, white / plastic, white  
 Aufbauleuchte; Stahl, weiss / Kunststoff, weiss  
 luminaire en saillie; acier, blanc / plastique, blanc

H 28, Ø 285



9 002759 992651



Ø 285

### 99266 FUEVA 5

surface-mounted light; steel, chrome / plastic, white  
 Aufbauleuchte; Stahl, chrom / Kunststoff, weiss  
 luminaire en saillie; acier, chrome / plastique, blanc

H 28, Ø 285



9 002759 992668



Ø 285

### 99267 FUEVA 5

surface-mounted light; steel, black / plastic, white  
 Aufbauleuchte; Stahl, schwarz / Kunststoff, weiss  
 luminaire en saillie; acier, noir / plastique, blanc

H 28, Ø 285



9 002759 992675



Ø 285



99267



IP44



99266



99268



IP44



99269



IP44

### 99268 FUEVA 5

surface-mounted light; steel, white / plastic, white  
 Aufbauleuchte; Stahl, weiss / Kunststoff, weiss  
 luminaire en saillie; acier, blanc / plastique, blanc

L 285, B 285, H 30



9 002759 992682



L 285

### 99269 FUEVA 5

surface-mounted light; steel, chrome / plastic, white  
 Aufbauleuchte; Stahl, chrom / Kunststoff, weiss  
 luminaire en saillie; acier, chrome / plastique, blanc

L 285, B 285, H 30



9 002759 992691



L 285

### 99271 FUEVA 5

surface-mounted light; steel, black / plastic, white  
 Aufbauleuchte; Stahl, schwarz / Kunststoff, weiss  
 luminaire en saillie; acier, noir / plastique, blanc

L 285, B 285, H 30



9 002759 992712



L 285



99271

LED



IP44



99269



97262

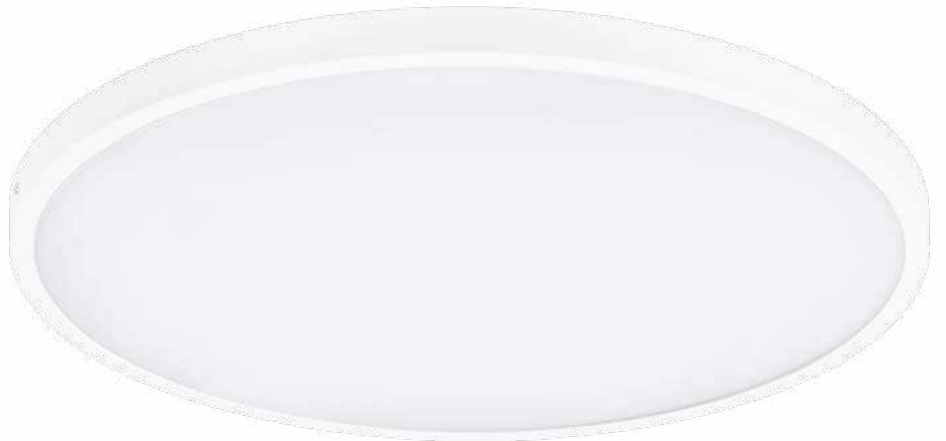

97279



97271



### 97262 FUEVA 1

surface-mounted light; aluminium, white / plastic, white  
Aufbauleuchte; Alu, weiss / Kunststoff, weiss  
luminaire en saillie; aluminium, blanc / plastique, blanc

H 30, Ø 400



25W 2500lm

### 97271 FUEVA 1

surface-mounted light; aluminium, white / plastic, white  
Aufbauleuchte; Alu, weiss / Kunststoff, weiss  
luminaire en saillie; aluminium, blanc / plastique, blanc

H 30, Ø 500



25W 2700lm

### 97279 FUEVA 1

surface-mounted light; aluminium, white / plastic, white  
Aufbauleuchte; Alu, weiss / Kunststoff, weiss  
luminaire en saillie; aluminium, blanc / plastique, blanc

H 30, Ø 600



27W 3200lm



9 002759 972622



Ø 400



9 002759 972714



Ø 500



9 002759 972790



Ø 600





97263

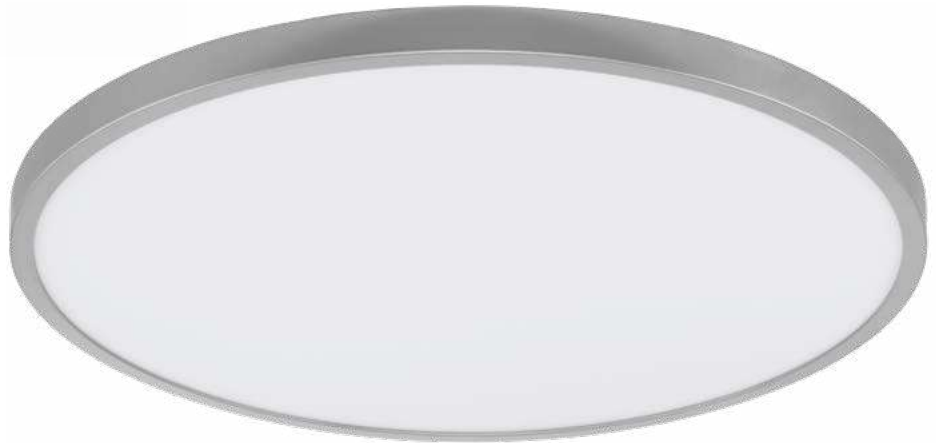

97552



97272



### 97263 FUEVA 1

surface-mounted light; aluminium, silver / plastic, white  
Aufbauleuchte; Alu, silber / Kunststoff, weiss  
luminaire en saillie; aluminium, argent / plastique, blanc

H 30, Ø 400



25W 2500lm

### 97272 FUEVA 1

surface-mounted light; aluminium, silver / plastic, white  
Aufbauleuchte; Alu, silber / Kunststoff, weiss  
luminaire en saillie; aluminium, argent / plastique, blanc

H 30, Ø 500



25W 2700lm

### 97552 FUEVA 1

surface-mounted light; aluminium, silver / plastic, white  
Aufbauleuchte; Alu, silber / Kunststoff, weiss  
luminaire en saillie; aluminium, argent / plastique, blanc

H 30, Ø 600



27W 3200lm



9 002759 972639



Ø 400



9 002759 972721



Ø 500



9 002759 975524



Ø 600



97266



97275



97267



### 97266 FUEVA 1

surface-mounted light; aluminium, white / plastic, white  
Aufbauleuchte; Alu, weiss / Kunststoff, weiss  
luminaire en saillie; aluminium, blanc / plastique, blanc

H 30, Ø 400



25W 2500lm

### 97275 FUEVA 1

surface-mounted light; aluminium, white / plastic, white  
Aufbauleuchte; Alu, weiss / Kunststoff, weiss  
luminaire en saillie; aluminium, blanc / plastique, blanc

H 30, Ø 500



25W 2900lm

### 97267 FUEVA 1

surface-mounted light; aluminium, silver / plastic, white  
Aufbauleuchte; Alu, silber / Kunststoff, weiss  
luminaire en saillie; aluminium, argent / plastique, blanc

H 30, Ø 400



25W 2500lm



9 002759 972660



Ø 400



9 002759 972752



Ø 500



9 002759 972677



Ø 400



97276



97276

### 97276 FUEVA 1

surface-mounted light; aluminium, silver / plastic, white  
Aufbauleuchte; Alu, silber / Kunststoff, weiss  
luminaire en saillie; aluminium, argent / plastique, blanc

H 30, Ø 500





97264



97282



97273



### 97264 FUEVA 1

surface-mounted light; aluminium, white / plastic, white  
 Aufbauleuchte; Alu, weiss / Kunststoff, weiss  
 luminaire en saillie; aluminium, blanc / plastique, blanc

L 400, B 400, H 30



25W 2500lm

### 97273 FUEVA 1

surface-mounted light; aluminium, white / plastic, white  
 Aufbauleuchte; Alu, weiss / Kunststoff, weiss  
 luminaire en saillie; aluminium, blanc / plastique, blanc

L 500, B 500, H 30



25W 2700lm

### 97282 FUEVA 1

surface-mounted light; aluminium, white / plastic, white  
 Aufbauleuchte; Alu, weiss / Kunststoff, weiss  
 luminaire en saillie; aluminium, blanc / plastique, blanc

L 600, B 600, H 30



27W 3200lm



9 002759 972646

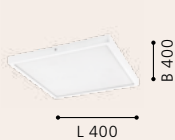

L 400



9 002759 972738

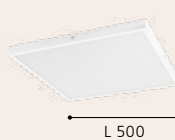

L 500



9 002759 972820

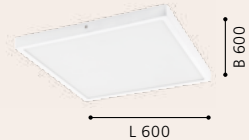

L 600



97265



97553



97274



### 97265 FUEVA 1

surface-mounted light; aluminium, silver / plastic, white  
 Aufbauleuchte; Alu, silber / Kunststoff, weiss  
 luminaire en saillie; aluminium, argent / plastique, blanc

L 400, B 400, H 30



### 97274 FUEVA 1

surface-mounted light; aluminium, silver / plastic, white  
 Aufbauleuchte; Alu, silber / Kunststoff, weiss  
 luminaire en saillie; aluminium, argent / plastique, blanc

L 500, B 500, H 30



### 97553 FUEVA 1

surface-mounted light; aluminium, silver / plastic, white  
 Aufbauleuchte; Alu, silber / Kunststoff, weiss  
 luminaire en saillie; aluminium, argent / plastique, blanc

L 600, B 600, H 30



9 002759 972653

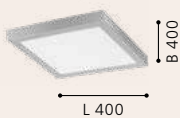

9 002759 972745

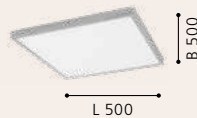

9 002759 975531

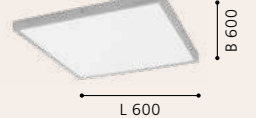



97268

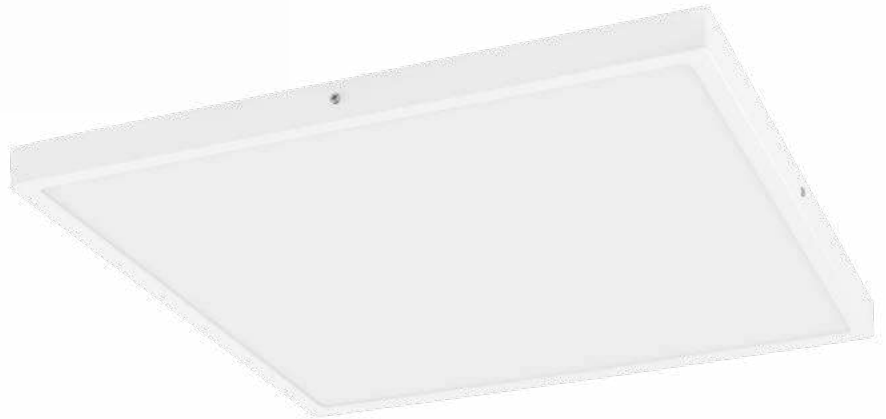

97277



97269



### 97268 FUEVA 1

surface-mounted light; aluminium, white / plastic, white  
Aufbauleuchte; Alu, weiss / Kunststoff, weiss  
luminaire en saillie; aluminium, blanc / plastique, blanc

L 400, B 400, H 30



25W 2500lm

### 97277 FUEVA 1

surface-mounted light; aluminium, white / plastic, white  
Aufbauleuchte; Alu, weiss / Kunststoff, weiss  
luminaire en saillie; aluminium, blanc / plastique, blanc

L 500, B 500, H 30



25W 2900lm

### 97269 FUEVA 1

surface-mounted light; aluminium, silver / plastic, white  
Aufbauleuchte; Alu, silber / Kunststoff, weiss  
luminaire en saillie; aluminium, argent / plastique, blanc

L 400, B 400, H 30



25W 2500lm



9 002759 972684



L 400

B 400



9 002759 972776

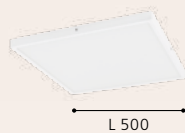

L 500

B 500



9 002759 972691



L 400

B 400





97278



97278

### 97278 FUEVA 1

surface-mounted light; aluminium, silver / plastic, white  
Aufbauleuchte; Alu, silber / Kunststoff, weiss  
luminaire en saillie; aluminium, argent / plastique, blanc

L 500, B 500, H 30

LED

25W

neutral  
WHITE

2900lm



9 002759 972783

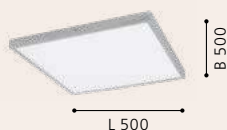



# SURFACE LUMINAIRES

## DECORATIVE

### ADVANTAGES

- > UNIFORM DISTRIBUTION OF INDIRECT LIGHT - IDEAL FOR ILLUMINATING SPACES AND SURFACES
  - > LOW TEMPERATURE ENHANCES SAFETY
  - > UP TO 80% POWER SAVINGS COMPARED TO INCANDESCENT LAMPS, EASY ON YOUR BUDGET AND THE ENVIRONMENT
- 

### VORTEILE

- > HOMOGENES, INDIREKTES LICHT – IDEAL ZUR BELEUCHTUNG VON RÄUMEN UND FLÄCHEN
  - > GERINGE WÄRMEENTWICKLUNG SORGT FÜR MEHR SICHERHEIT
  - > BIS ZU 80% STROMERSPARNIS GEGENÜBER GLÜHLAMPEN, SCHONT IHR BUDGET UND DIE UMWELT
- 

### ADVANTAGES

- > LA DISTRIBUTION UNIFORME DE LA LUMIÈRE INDIRECTE - IDÉAL POUR LES ESPACES ET LES SURFACES ÉCLAIRANTES
- > FAIBLE CHALEUR AMÉLIORE LA SÉCURITÉ
- > JUSQU'À 80% D'ÉCONOMIES D'ÉNERGIE PAR RAPPORT AUX LAMPES À INCANDESCENCE, RÉDUIT VOTRE BUDGET ET PROTÈGE L'ENVIRONNEMENT

# OVERVIEW

**5** year warranty  
Jahre Garantie  
ans de garantie  
anni di garanzia  
años de garantía  
anos de garantia



CRESPILLO  
208



CRESPILLO  
208



POLASSO  
210



POLASSO  
210



POLASSO  
210



POLASSO  
211



POLASSO  
212

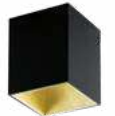

POLASSO  
212



POLASSO  
212



POLASSO  
213



FERREROS  
214



FERREROS  
214



FERREROS  
214



FERREROS  
215



SALUZZO  
216



SALUZZO  
216



GRIMASOLA  
218



GRIMASOLA  
218



GRIMASOLA  
218



GRIMASOLA  
219



LOKE 1  
220



LOKE 1  
220



LOKE 1  
220



LOKE 1  
221





99337



99338



### 99337 CRESPILO

surface-mounted light; plastic, steel, white / plastic, white  
 Aufbauleuchte; Kunststoff, Stahl, weiss / Kunststoff, weiss  
 luminaire en saillie; plastique, acier, blanc / plastique, blanc

H 45, Ø 240



16W 1400lm

### 99338 CRESPILO

surface-mounted light; plastic, steel, white / plastic, white  
 Aufbauleuchte; Kunststoff, Stahl, weiss / Kunststoff, weiss  
 luminaire en saillie; plastique, acier, blanc / plastique, blanc

H 45, Ø 315



18W 2000lm



9 002759 993375



Ø 240



9 002759 993382



Ø 315





99338





94501



94502



94504



### 94501 POLASSO

ceiling light; aluminium, plastic, black, copper  
Deckenleuchte; Alu, Kunststoff, schwarz, kupfer  
plafonnier; aluminium, plastique, noir, cuivre

H 120, Ø 100



1x 3,3W  
1x 340lm



9 002759 945015



### 94504 POLASSO

ceiling light; aluminium, plastic, white, silver  
Deckenleuchte; Alu, Kunststoff, weiss, silber  
plafonnier; aluminium, plastique, blanc, argent

H 120, Ø 100

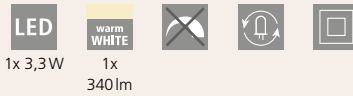

1x 3,3W  
1x 340lm



9 002759 945046



### 94502 POLASSO

ceiling light; aluminium, plastic, black, gold  
Deckenleuchte; Alu, Kunststoff, schwarz, gold  
plafonnier; aluminium, plastique, noir, or

H 120, Ø 100



1x 3,3W  
1x 340lm



9 002759 945022







94503

LED



94501

### 94503 POLASSO

ceiling light; aluminium, plastic, white, gold  
Deckenleuchte; Alu, Kunststoff, weiss, gold  
plafonnier; aluminium, plastique, blanc, or

H 120, Ø 100

LED

warm  
WHITE



1x 3,3W

1x

340lm



9 002759 945039



H 120

Ø 100





94496



94498



94497



### 94496 POLASSO

ceiling light; aluminium, plastic, black, copper  
Deckenleuchte; Alu, Kunststoff, schwarz, kupfer  
plafonnier; aluminium, plastique, noir, cuivre

L 100, B 100, H 120



1x 3,3W  
1x 340lm



9 002759 944964



### 94497 POLASSO

ceiling light; aluminium, plastic, black, gold  
Deckenleuchte; Alu, Kunststoff, schwarz, gold  
plafonnier; aluminium, plastique, noir, or

L 100, B 100, H 120



1x 3,3W  
1x 340lm



9 002759 944971



### 94498 POLASSO

ceiling light; aluminium, plastic, white, gold  
Deckenleuchte; Alu, Kunststoff, weiss, gold  
plafonnier; aluminium, plastique, blanc, or

L 100, B 100, H 120



1x 3,3W  
1x 340lm



9 002759 944988

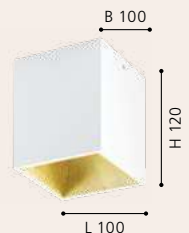



94499



94497

### 94499 POLASSO

ceiling light; aluminium, plastic, white, silver  
Deckenleuchte; Alu, Kunststoff, weiss, silber  
plafonnier; aluminium, plastique, blanc, argent

L 100, B 100, H 120



1x 3,3W  
1x 340lm

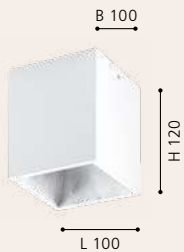

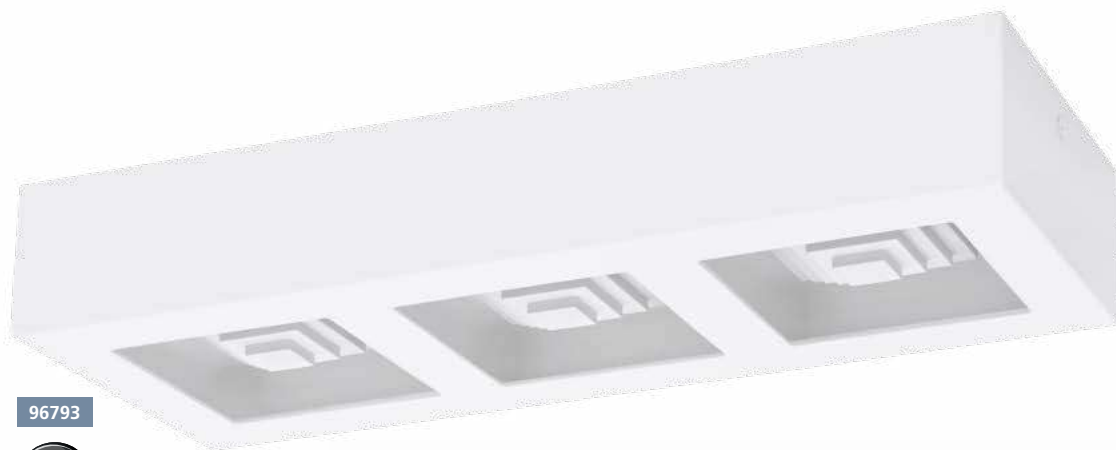

96793

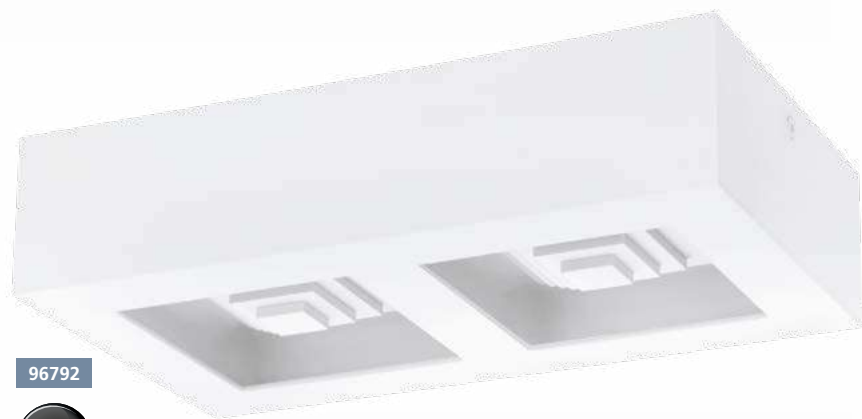

96792

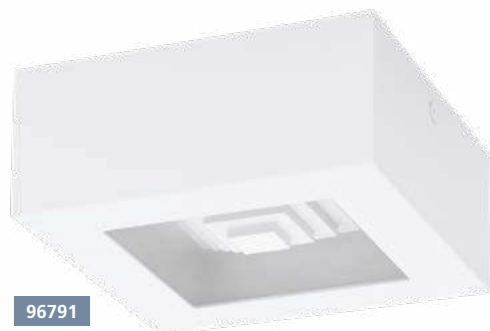

96791



## FERREROS

These luminaires have a special leveling effect.

Diese Leuchten besitzen einen besonderen Stufeneffekt.

Ces luminaires ont un effet escalier spécial.

### 96791 FERREROS

wall / ceiling light; steel, white / plastic, white  
Wand- / Deckenleuchte; Stahl, weiss / Kunststoff, weiss  
applique / plafonnier; acier, blanc / plastique, blanc

L 140, B 140, H 60



1x 6,3W  
1x 840lm



9 002759 967918

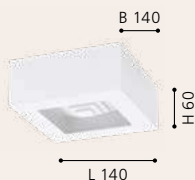

### 96792 FERREROS

wall / ceiling light; steel, white / plastic, white  
Wand- / Deckenleuchte; Stahl, weiss / Kunststoff, weiss  
applique / plafonnier; acier, blanc / plastique, blanc

L 255, B 140, H 60



2x 6,3W  
2x 840lm



9 002759 967925

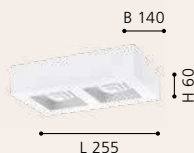

### 96793 FERREROS

wall / ceiling light; steel, white / plastic, white  
Wand- / Deckenleuchte; Stahl, weiss / Kunststoff, weiss  
applique / plafonnier; acier, blanc / plastique, blanc

L 370, B 140, H 60



3x 6,3W  
3x 840lm



9 002759 967932

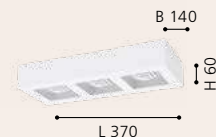

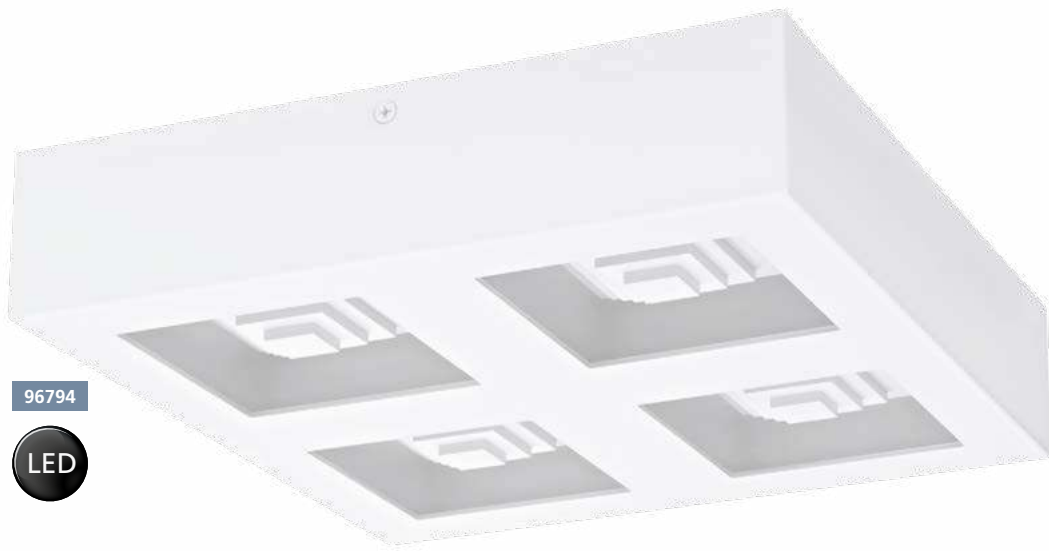

96794



96794

### 96794 FERREROS

wall / ceiling light; steel, white / plastic, white  
 Wand- / Deckenleuchte; Stahl, weiss / Kunststoff, weiss  
 applique / plafonnier; acier, blanc / plastique, blanc

L 270, B 270, H 60

LED

4x 6,3W

warm  
 WHITE

4x

840lm

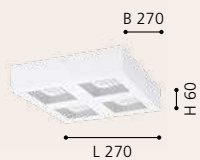





99065



99066



### 99065 SALUZZO

surface-mounted light; steel, black  
Aufbauleuchte; Stahl, schwarz  
luminaire en saillie; acier, noir

H 110, Ø 65



E27 1x 40W



9 002759 990657



Ø 65

### 99066 SALUZZO

surface-mounted light; steel, white  
Aufbauleuchte; Stahl, weiss  
luminaire en saillie; acier, blanc

H 110, Ø 65



E27 1x 40W



9 002759 990664



Ø 65





99065





99281



99283



99282

### 99281 GRIMASOLA

surface-mounted light; aluminium, steel, white / plastic, white  
 Aufbauleuchte; Alu, Stahl, weiss / Kunststoff, weiss  
 luminaire en saillie; aluminium, acier, blanc / plastique, blanc

L 140, B 140, H 110



E27 1x 28W

### 99282 GRIMASOLA

surface-mounted light; aluminium, steel, white / plastic, white  
 Aufbauleuchte; Alu, Stahl, weiss / Kunststoff, weiss  
 luminaire en saillie; aluminium, acier, blanc / plastique, blanc

L 240, B 140, H 110



E27 2x 28W

### 99283 GRIMASOLA

surface-mounted light; aluminium, steel, black / plastic, white  
 Aufbauleuchte; Alu, Stahl, schwarz / Kunststoff, weiss  
 luminaire en saillie; aluminium, acier, noir / plastique, blanc

L 140, B 140, H 110



E27 1x 28W



9 002759 992811

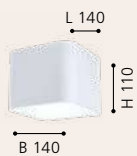

9 002759 992828

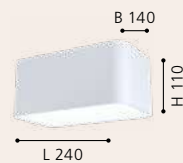

9 002759 992835





99284



99283

### 99284 GRIMASOLA

surface-mounted light; aluminium, steel, black / plastic, white  
Aufbauleuchte; Alu, Stahl, schwarz / Kunststoff, weiss  
luminaire en saillie; aluminium, acier, noir / plastique, blanc

L 240, B 140, H 110



E27



2x 28W



9 002759 992842

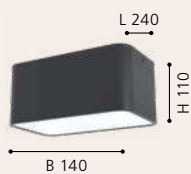

SURFACE



91352



91353



91354



### 91352 LOKE 1

surface-mounted light; aluminium, steel, brushed aluminium, chrome, black

Aufbauleuchte; Alu, Stahl, alu-gebürstet, chrom, schwarz  
luminaire en saillie; aluminium, acier, aluminium brossé, chrome, noir

L 140, B 140, A 85



GU10



1x 5W



warm  
WHITE  
1x  
400lm

### 91353 LOKE 1

surface-mounted light; aluminium, steel, brushed aluminium, chrome, black

Aufbauleuchte; Alu, Stahl, alu-gebürstet, chrom, schwarz  
luminaire en saillie; aluminium, acier, aluminium brossé, chrome, noir

L 250, B 140, A 85



GU10



2x 5W



warm  
WHITE  
2x  
400lm

### 91354 LOKE 1

surface-mounted light; aluminium, steel, brushed aluminium, chrome, black

Aufbauleuchte; Alu, Stahl, alu-gebürstet, chrom, schwarz  
luminaire en saillie; aluminium, acier, aluminium brossé, chrome, noir

L 360, B 140, A 85



GU10



3x 5W



warm  
WHITE  
3x  
400lm



9 002759 913526

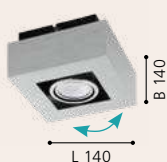

L 140



9 002759 913533



L 250



9 002759 913540



L 360



91355

LED



91355

### 91355 LOKE 1

surface-mounted light; aluminium, steel, brushed aluminium, chrome, black

Aufbauleuchte; Alu, Stahl, alu-gebürstet, chrom, schwarz  
 luminaire en saillie; aluminium, acier, aluminium brossé, chrome, noir

L 250, B 250, A 85



GU10



4x 5W

warm  
WHITE

4x  
400lm



9 002759 913557



INCL.



SURFACE





# LED STRIPES

## FLAIR FOR YOUR HOME -

LED STRIPS ARE AVAILABLE IN VARIOUS LENGTHS AND FOR NUMEROUS FIELDS OF APPLICATIONS. CHOOSE YOUR LIGHTING PROGRAMME AND COLOUR IN LINE WITH WHAT SUITS YOUR HOME AND YOUR MOOD. THANKS TO THE ADHESIVE TAPE ON THE BACK OF THE STRIPES, YOU CAN MOUNT THEM ANYWHERE IN NO TIME, USING THEM AS UNDER CABINET LIGHTING IN YOUR KITCHEN OR IN THE LIVING ROOM AREA.

LET YOURSELF BE INSPIRED BY EGLO LED STRIPES!

---

## FLAIR IN IHREM ZUHAUSE -

LED STRIPS IN VERSCHIEDENEN LÄNGEN UND FÜR VIELE EINSATZBEREICHE WERDEN EINFACH MIT EINEM KLEBEBAND BEFESTIGT. JE NACH STIMMUNG KÖNNEN SIE DAS ENTSPRECHENDE LICHTPROGRAMM BZW. DIE GEEIGNETE FARBE AUSWÄHLEN - VON DER INDIRECTEN BELEUCHTUNG IN DER KÜCHENVITRINE BIS HIN ZUM WOHNZIMMER.

LASSEN SIE SICH VON DEN EGLO LED STRIPES INSPIRIEREN!

---

## CRÉER DES AMBIANCES PERSONNALISÉES -

LES LED STRIPS SONT DISPONIBLES EN DIFFÉRENTES TAILLES ET PEUVENT ÊTRE UTILISÉS POUR DE NOMBREUSES APPLICATIONS DIFFÉRENTES. IL EXISTE DES BANDEAUX DE LED ADAPTÉS À CHAQUE PIÈCE. VOUS POURREZ CHOISIR LE PROGRAMME LUMINEUX ET LA COULEUR QUI CORRESPOND LE MIEUX À VOTRE INTÉRIEUR ET VOTRE HUMEUR.

LAISSÉZ-VOUS INSPIRER PAR LES LED STRIPES EGLO !







98571

98572



# FLEXIBLE STRIPES

## ADVANTAGES

- > FREELY FORMABLE
- > SELF-ADHESIVE
- > SEPARABLE EVERY 10 CM
- > OPTIMAL ILLUMINATION EVEN IN CORNERS
- > NO SOLDERING OR INTERMEDIATE PIECE NECESSARY

## VORTEILE

- > FREI FORMBAR
- > SELBSTKLEBEND
- > ALLE 10 CM KÜRZBAR
- > OPTIMALE AUSLEUCHTUNG AUCH IN ECKEN
- > KEIN LÖTEN ODER ZWISCHENSTÜCK NOTWENDIG

## ADVANTAGES

- > SE DÉFORME AISÉMENT
- > AUTO-ADHÉSIF
- > PEUT ÊTRE SECTIONNÉ TOUS LES 10 CM
- > UN ÉCLAIRAGE OPTIMAL, MÊME DANS LES COINS
- > PAS DE SOUDURE OU DE PIÈCE INTERMÉDIAIRE NÉCESSAIRE

### 98571 FLEXIBLE STRIPE

bar / strip light; plastic, white  
 Leuchtband/-stab; Kunststoff, weiss  
 bande lumineuse / bâton l; plastique, blanc

L 2000, B 6



9 002759 985714

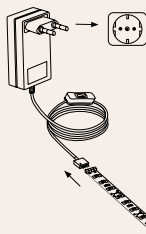

### 98572 FLEXIBLE STRIPE

bar / strip light; plastic, white  
 Leuchtband/-stab; Kunststoff, weiss  
 bande lumineuse / bâton l; plastique, blanc

L 5000, B 6



9 002759 985721

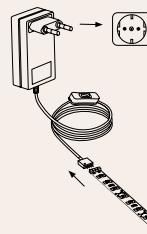

### 98573 FLEXIBLE STRIPE

bar / strip light; plastic, white  
 Leuchtband/-stab; Kunststoff, weiss  
 bande lumineuse / bâton l; plastique, blanc

L 2000, B 6



9 002759 985738

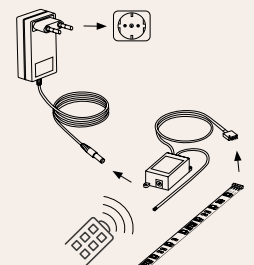

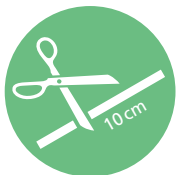

98573

98574

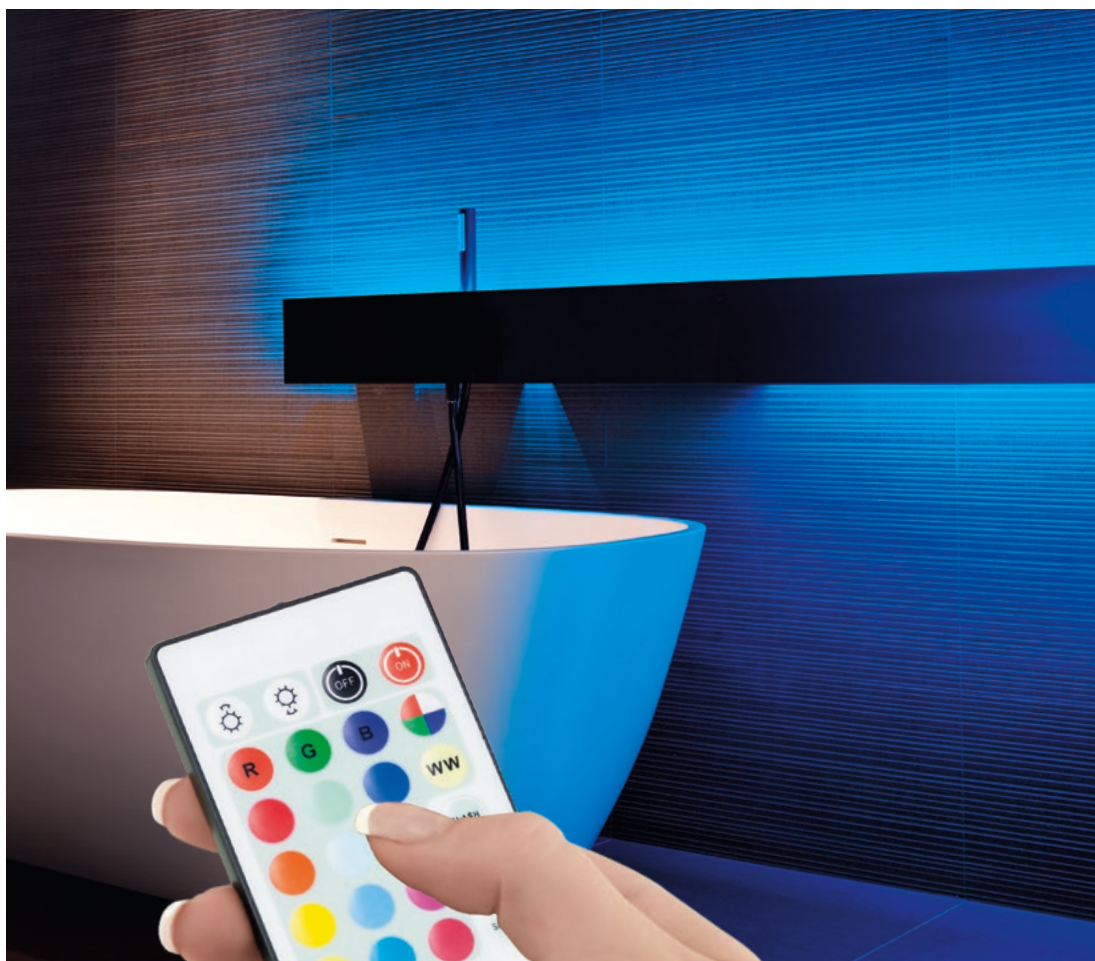

### 98574 FLEXIBLE STRIPE

bar / strip light; plastic, white  
Leuchtband/-stab; Kunststoff, weiss  
bande lumineuse / bâton l; plastique, blanc

L 5000, B 6



19,5W



9 002759 985745

### 98573, 98574

These articles include a remote control.

Bei diesen Artikeln ist eine Fernbedienung inkludiert.

Ces articles comprennent une télécommande.





97929

97931



IP44

97929, 97931, 97925, 97926



97929, 97931

These articles include a remote control.

Bei diesen Artikeln ist eine Fernbedienung inkludiert.

Ces articles comprennent une télécommande.



97929 LED STRIPES-FLEX

bar / strip light; plastic, transparent  
 Leuchtband/-stab; Kunststoff, transparent  
 bande lumineuse / bâton l; plastique, transparent

L 2000, B 10, H 3



97931 LED STRIPES-FLEX

bar / strip light; plastic, transparent  
 Leuchtband/-stab; Kunststoff, transparent  
 bande lumineuse / bâton l; plastique, transparent

L 5000, B 10, H 3



L 2000



L 5000





97926

97925



IP44

### 97925 LED STRIPES-FLEX

bar / strip light; plastic, transparent  
 Leuchtband/-stab; Kunststoff, transparent  
 bande lumineuse / bâton l; plastique, transparent

L 2000, B 10, H 3



L 2000



### 97926 LED STRIPES-FLEX

bar / strip light; plastic, transparent  
 Leuchtband/-stab; Kunststoff, transparent  
 bande lumineuse / bâton l; plastique, transparent

L 5000, B 10, H 3



L 5000



### 97925, 97926

These articles include a remote control.

Bei diesen Artikeln ist eine Fernbedienung inkludiert.

Ces articles comprennent une télécommande.





97928

97927

### 97927, 97928



### 97927, 97928

These articles include a remote control.

Bei diesen Artikeln ist eine Fernbedienung inkludiert.

Ces articles comprennent une télécommande.

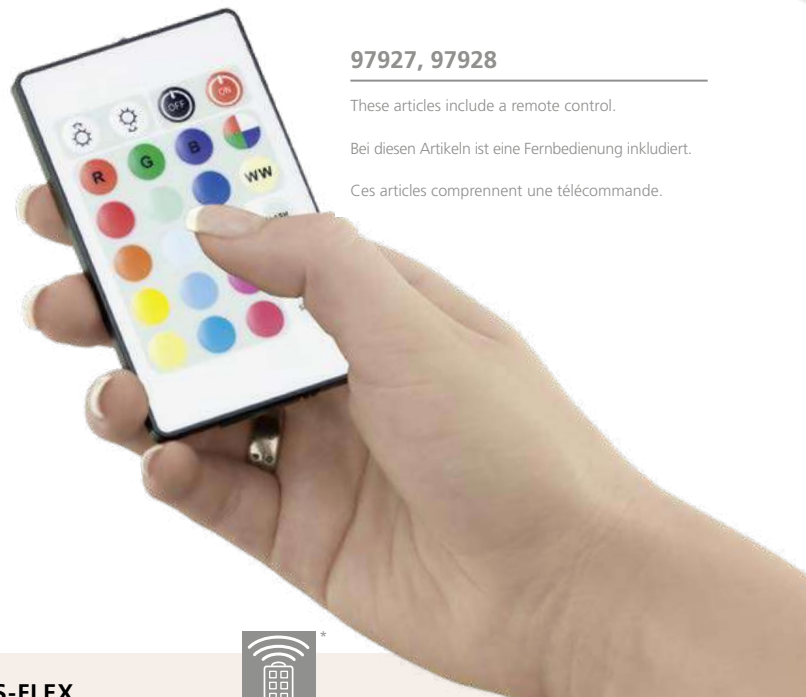

### 97927 LED STRIPES-FLEX

bar / strip light; plastic, transparent  
Leuchtband/-stab; Kunststoff, transparent  
bande lumineuse / bâton l; plastique, transparent

L 2000, B 10, H 3



### 97928 LED STRIPES-FLEX

bar / strip light; plastic, transparent  
Leuchtband/-stab; Kunststoff, transparent  
bande lumineuse / bâton l; plastique, transparent

L 5000, B 10, H 3



### REMOTE CONTROL

With the aid of the remote control, all LED STRIPES can be dimmed. The "not dimmable" sign shown in the technical info is only valid for utilisation without the remote control.

Mit Hilfe der Fernbedienung können sämtliche LED-STRIPES gedimmt werden. Das „nicht dimmbar“ Zeichen in der technischen Information trifft nur für die Benutzung ohne Fernbedienung zu.

Au moyen de la télécommande, tous les LED STRIPES peuvent être gradués. Le signe « non graduable » dans l'information technique n'est valable que dans le cas d'utilisation sans télécommande.

\* This notice indicates that the remote control is included with the delivery.

\* Bei diesem Hinweis ist die Fernbedienung im Lieferumfang enthalten!

\* Avec cette remarque, la télécommande est comprise dans l'étendue de la livraison !







97029

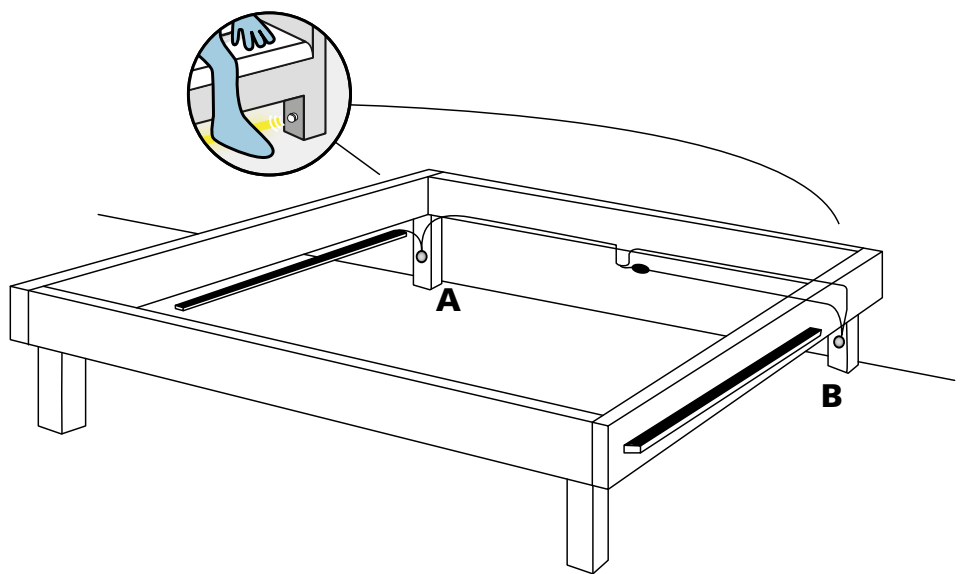

### 97029 PIDIO

bar / strip light; plastic, white  
 Leuchtband/-stab; Kunststoff, weiss  
 bande lumineuse / bâton l; plastique, blanc

L 2400, B 8, H 2



### 97029 PIDIO

This sensor strip is designed to be attached to the side of the bed. Properly placed and connected to the supplied LED lights, it will illuminate the base of your bed.

The sensor has a 100 degree arc and a 3.5m range. It can be set to automatically activate the light between 30 seconds and 10 minutes.

Diese Sensorleiste ist so konzipiert, dass sie an der Seite des Bettes befestigt werden kann. Richtig platziert und mit den mitgelieferten LED-Streifenleuchten verbunden, wird sie die Basis Ihres Bettes beleuchten. Der Sensor hat einen 100 Grad Bogen und eine 3,5m Reichweite. Er kann so eingestellt werden, dass das Licht zwischen 30 Sekunden und 10 Minuten automatisch aktiviert wird.

Cette barre de capteur est conçu de telle sorte qu'il peut être fixé sur le côté du lit. Correctement placé et connecté à la bande LED fournis, il allume la base du lit. Le capteur a un arc de 100 degrés et une portée de 3,5 m. Il peut être réglé de telle sorte que la lumière est activé entre 30 secondes et 10 minutes automatiquement.

92051



### 92051 LED STRIPES-DECO

bar / strip light; plastic, white  
Leuchtband/-stab; Kunststoff, weiss  
bande lumineuse / bâton l; plastique, blanc

L 1170



3x 1,6W 330lm  
(3x 20 LED)

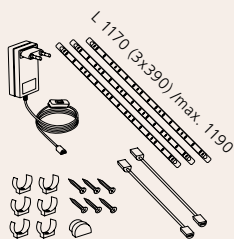

92051

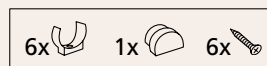
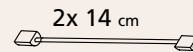
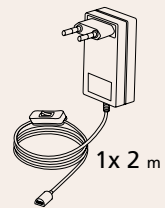



# LED PROFILES

## ADVANTAGES

- > SIMPLE AND FAST INSTALLATION
  - > DIFFERENT SHAPES AND SIZES
  - > VARIETY OF COLOURS
  - > PROFILES GIVE LED STRIPS A MORE ELEGANT DESIGN
  - > PROTECTION AGAINST MECHANICAL STRESS OF THE LED STRIPS
- 

## VORTEILE

- > EINFACHE UND SCHNELLE MONTAGE
  - > UNTERSCHIEDLICHE FORMEN UND GRÖSSEN
  - > FARBENVIELFALT
  - > PROFILE VERLEIHEN LED-STRIPS EIN EDLERES DESIGN
  - > SCHUTZ VOR MECHANISCHER BEANSPRUCHUNG DER LED STRIPS
- 

## ADVANTAGES

- > INSTALLATION SIMPLE ET RAPIDE
- > DIFFÉRENTES FORMES ET TAILLES
- > VARIÉTÉ DE COULEURS
- > LES PROFILS DONNENT AUX BANDES LED UN DESIGN PLUS ÉLÉGANT
- > PROTECTION CONTRE LES CONTRAINTES MÉCANIQUES DES BANDES LED

# OVERVIEW



SURFACE PROFILE 1  
**236**



SURFACE PROFILE 1  
**237**



SURFACE PROFILE 1  
**238**



SURFACE PROFILE 2  
**239**



SURFACE PROFILE 2  
**240**



SURFACE PROFILE 2  
**241**



SURFACE PROFILE 3  
**242**



SURFACE PROFILE 3  
**243**



SURFACE PROFILE 3  
**244**



CORNER PROFILE 1  
**246**



CORNER PROFILE 1  
**248**



CORNER PROFILE 1  
**250**



CORNER PROFILE 2  
**252**



CORNER PROFILE 2  
**254**



CORNER PROFILE 2  
**256**



SURFACE PROFILE 4  
**258**



SURFACE PROFILE 4  
**259**



RECESSED PROFILE 1  
**260**



RECESSED PROFILE 1  
**261**



RECESSED PROFILE 1  
**262**



RECESSED PROFILE 2  
**263**



RECESSED PROFILE 2  
**264**



RECESSED PROFILE 2  
**265**



SURFACE PROFILE 5  
**266**



RECESSED PROFILE 3  
**268**



RECESSED PROFILE 3  
**268**



RECESSED PROFILE 3  
**269**



SURFACE PROFILE 6  
**270**



SURFACE PROFILE 6  
**271**





# LED CORNER CONNECTORS

## ADVANTAGES

- > PREFABRICATED 90° CORNER CONNECTORS
- > NO MITRE SAWING NECESSARY
- > EASY MOUNTING
- > SUITABLE FOR INSIDE AND OUTSIDE CORNERS
- > BRACKETS INCLUDED

---

## VORTEILE

- > VORGEFERTIGTE 90° ECKVERBINDER
- > KEIN GEHRUNGSSÄGEN NOTWENDIG
- > EINFACHE MONTAGE
- > FÜR INNEN- UND AUSSENECKEN EINSETZBAR
- > HALTERUNGEN INKLUSIVE

---

## ADVANTAGES

- > CONNECTEURS D'ANGLE À 90° PRÉFABRIQUÉS
- > PAS DE SCIAGE EN ONGLET NÉCESSAIRE
- > MONTAGE FACILE
- > CONVIENT AUX ANGLES INTÉRIEURS ET EXTÉRIEURS
- > ENTRE PARENTHÈSES

**1**

x2

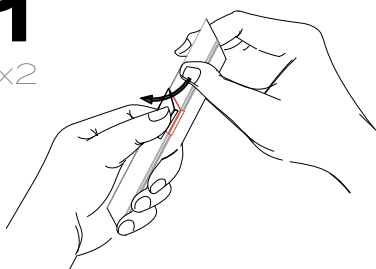

**2**

x2

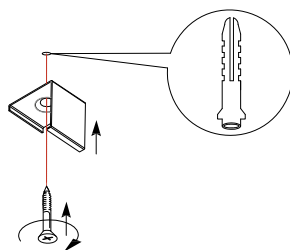

**3**

x2

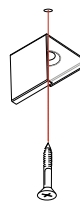

**4**

x2

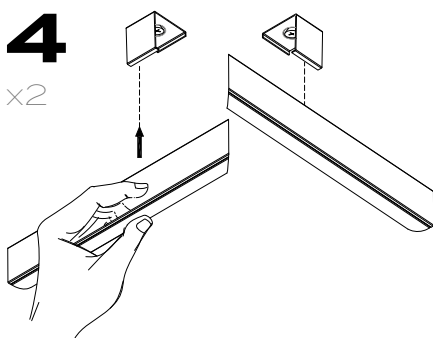

**5**

x2

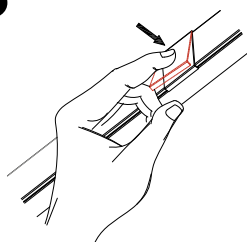

**6**

x2

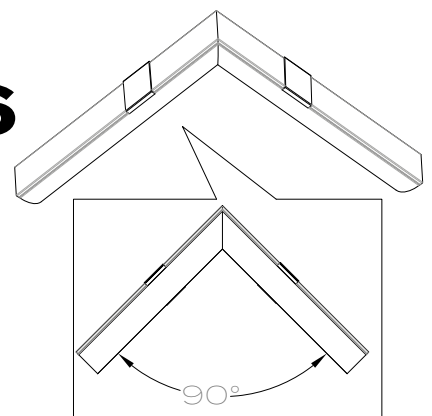



# OVERVIEW



SURFACE PROFILE 1  
**236**



SURFACE PROFILE 1  
**237**



SURFACE PROFILE 1  
**238**



SURFACE PROFILE 2  
**239**



SURFACE PROFILE 2  
**240**



SURFACE PROFILE 2  
**241**



SURFACE PROFILE 3  
**242**



SURFACE PROFILE 3  
**243**



SURFACE PROFILE 3  
**244**



CORNER PROFILE 1  
**246**



CORNER PROFILE 1  
**247**



CORNER PROFILE 1  
**248**



CORNER PROFILE 1  
**249**



CORNER PROFILE 1  
**250**



CORNER PROFILE 1  
**251**



CORNER PROFILE 2  
**252**



CORNER PROFILE 2  
**253**



CORNER PROFILE 2  
**254**



CORNER PROFILE 2  
**255**



CORNER PROFILE 2  
**256**



CORNER PROFILE 2  
**257**



RECESSED PROFILE 1  
**260**



RECESSED PROFILE 1  
**261**



RECESSED PROFILE 1  
**262**



RECESSED PROFILE 2  
**263**



RECESSED PROFILE 2  
**264**



RECESSED PROFILE 2  
**265**



L 1000  
mm

98911

L 2000  
mm

98912

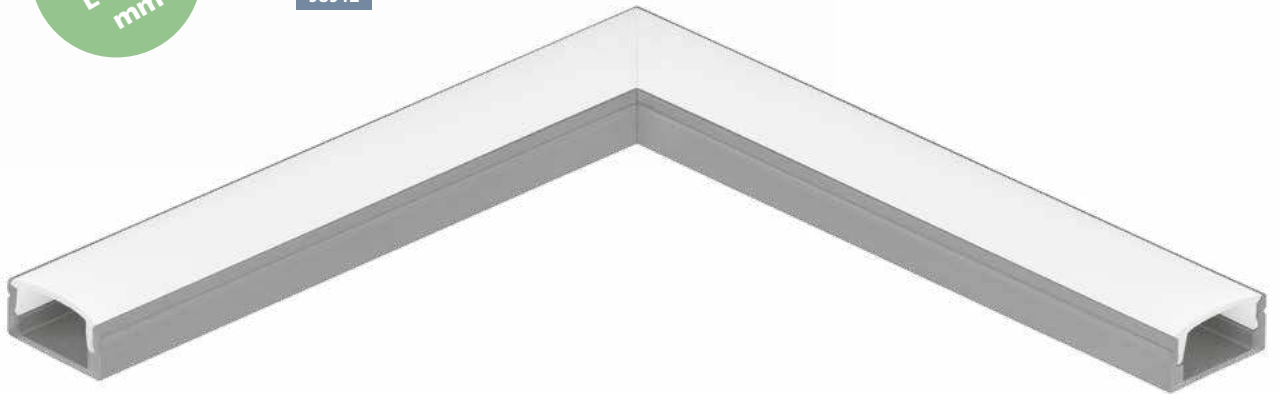

98913

**INCLUDED IN DELIVERY /**

im Lieferumfang enthalten /  
inclus dans la livraison



98911  
98912



98914  
98915

**98911 SURFACE PROFILE 1**

accessory; aluminium, aluminium / plastic, white  
Zubehör; Alu, alu / Kunststoff, weiss  
accessoire; aluminium, aluminium / plastique, blanc

L 1000, B 17, H 9



9 002759 989118

**98912 SURFACE PROFILE 1**

accessory; aluminium, aluminium / plastic, white  
Zubehör; Alu, alu / Kunststoff, weiss  
accessoire; aluminium, aluminium / plastique, blanc

L 2000, B 17, H 9



9 002759 989125

**98913 SURFACE PROFILE 1**

accessory; aluminium, aluminium  
Zubehör; Alu, alu  
accessoire; aluminium, aluminium

L 110



9 002759 989132

# SURFACE PROFILES

incl. end caps & mounting clips



98914

L 1000  
mm



98915

L 2000  
mm



98916

### 98914 SURFACE PROFILE 1

accessory; aluminium, white / plastic, white  
Zubehör; Alu, weiss / Kunststoff, weiss  
accessoire; aluminium, blanc / plastique, blanc

L 1000, B 17, H 9



9 002759 989149

### 98915 SURFACE PROFILE 1

accessory; aluminium, white / plastic, white  
Zubehör; Alu, weiss / Kunststoff, weiss  
accessoire; aluminium, blanc / plastique, blanc

L 2000, B 17, H 9



9 002759 989156

### 98916 SURFACE PROFILE 1

accessory; aluminium, white  
Zubehör; Alu, weiss  
accessoire; aluminium, blanc

L 110



9 002759 989163

### PROFILE CROSS-SECTION / Profilquerschnitt / section de profil

98911 98913 98915  
98912 98914 98916

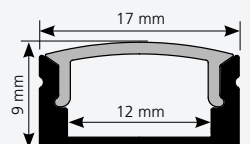

**INCLUDED IN DELIVERY /**

im Lieferumfang enthalten /  
inclus dans la livraison



98917  
98918



98921  
98922



L 1000  
mm

98917



L 2000  
mm

98918

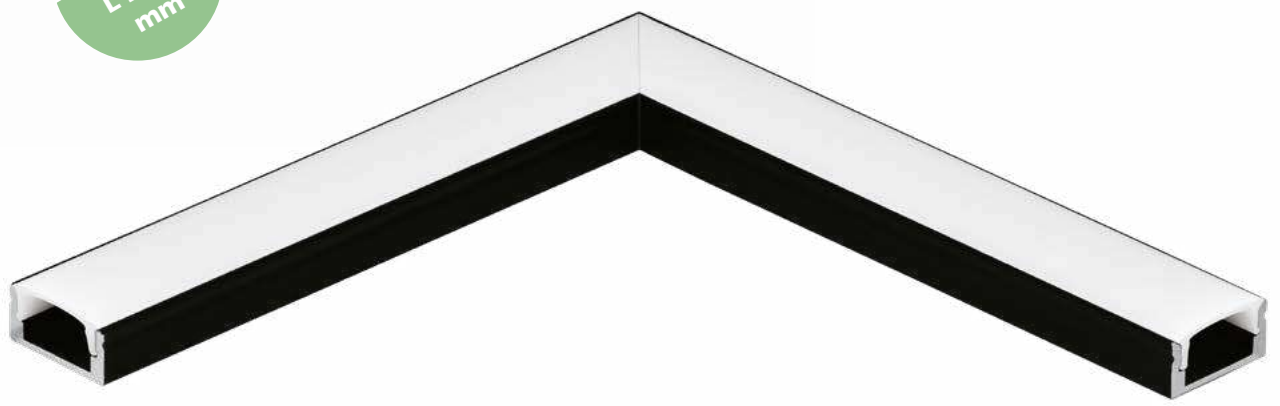

98919

**98917 SURFACE PROFILE 1**

accessory; aluminium, black / plastic, white  
Zubehör; Alu, schwarz / Kunststoff, weiss  
accessoire; aluminium, noir / plastique, blanc

L 1000, B 17, H 9



9 002759 989170

**98918 SURFACE PROFILE 1**

accessory; aluminium, black / plastic, white  
Zubehör; Alu, schwarz / Kunststoff, weiss  
accessoire; aluminium, noir / plastique, blanc

L 2000, B 17, H 9



9 002759 989187

**98919 SURFACE PROFILE 1**

accessory; aluminium, anodised black  
Zubehör; Alu, schwarz eloxiert  
accessoire; aluminium, noir anodisé

L 110



9 002759 989194

**SURFACE PROFILES**

incl. end caps & mounting clips

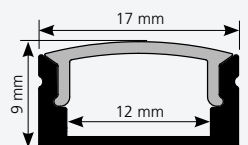

98917 98919  
98918



98921

L 1000  
mm



98922

L 2000  
mm



98923

**98921 SURFACE PROFILE 2**

accessory; aluminium, aluminium / plastic, white  
Zubehör; Alu, alu / Kunststoff, weiss  
accessoire; aluminium, aluminium / plastique, blanc

L 1000, B 17, H 16



9 002759 989217

**98922 SURFACE PROFILE 2**

accessory; aluminium, aluminium / plastic, white  
Zubehör; Alu, alu / Kunststoff, weiss  
accessoire; aluminium, aluminium / plastique, blanc

L 2000, B 17, H 16



9 002759 989224

**98923 SURFACE PROFILE 2**

accessory; aluminium, aluminium  
Zubehör; Alu, alu  
accessoire; aluminium, aluminium

L 110



9 002759 989231

**PROFILE CROSS-SECTION /**  
Profilquerschnitt / section de profil

98921 98923  
98922

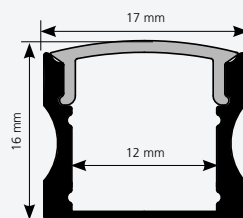





98924

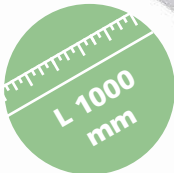

98925

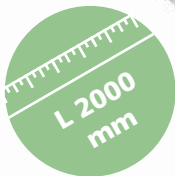

98926

**INCLUDED IN DELIVERY /**

im Lieferumfang enthalten /  
inclus dans la livraison



98924  
98925



98927  
98928

**98924 SURFACE PROFILE 2**

accessory; aluminium, white / plastic, white  
Zubehör; Alu, weiss / Kunststoff, weiss  
accessoire; aluminium, blanc / plastique, blanc

L 1000, B 17, H 16



9 002759 989248

**98925 SURFACE PROFILE 2**

accessory; aluminium, white / plastic, white  
Zubehör; Alu, weiss / Kunststoff, weiss  
accessoire; aluminium, blanc / plastique, blanc

L 2000, B 17, H 16



9 002759 989255

**98926 SURFACE PROFILE 2**

accessory; aluminium, white  
Zubehör; Alu, weiss  
accessoire; aluminium, blanc

L 110



9 002759 989262

# SURFACE PROFILES

incl. end caps & mounting clips

98927

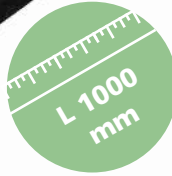

98928

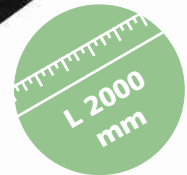

98929

### 98927 SURFACE PROFILE 2

accessory; aluminium, black / plastic, white  
Zubehör; Alu, schwarz / Kunststoff, weiss  
accessoire; aluminium, noir / plastique, blanc

L 1000, B 17, H 16



9 002759 989279

### 98928 SURFACE PROFILE 2

accessory; aluminium, black / plastic, white  
Zubehör; Alu, schwarz / Kunststoff, weiss  
accessoire; aluminium, noir / plastique, blanc

L 2000, B 17, H 16



9 002759 989286

### 98929 SURFACE PROFILE 2

accessory; aluminium, anodised black  
Zubehör; Alu, schwarz eloxiert  
accessoire; aluminium, noir anodisé

L 110



9 002759 989293

### PROFILE CROSS-SECTION / Profilquerschnitt / section de profil

98924 98926 98928  
98925 98927 98929

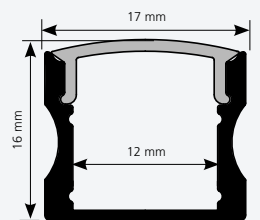



L 1000  
mm

98931



L 2000  
mm

98932



98933

**INCLUDED IN DELIVERY /**  
im Lieferumfang enthalten /  
inclus dans la livraison



98931  
98932



98937  
98938

**98931 SURFACE PROFILE 3**

accessory; aluminium, aluminium / plastic, transparent  
Zubehör; Alu, alu / Kunststoff, transparent  
accessoire; aluminium, aluminium / plastique, transparent

L 1000, B 17, H 20



9 002759 989316

**98932 SURFACE PROFILE 3**

accessory; aluminium, aluminium / plastic, transparent  
Zubehör; Alu, alu / Kunststoff, transparent  
accessoire; aluminium, aluminium / plastique, transparent

L 2000, B 17, H 20



9 002759 989323

**98933 SURFACE PROFILE 3**

accessory; aluminium, aluminium  
Zubehör; Alu, alu  
accessoire; aluminium, aluminium

L 110



9 002759 989330

**SURFACE PROFILES WITH 30° LINEAR LENS**

incl. end caps & mounting clips



98937

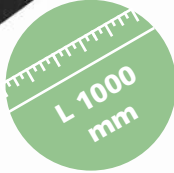

98938

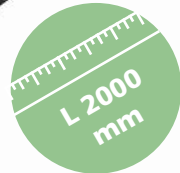

98939

### 98937 SURFACE PROFILE 3

accessory; aluminium, black / plastic, transparent  
Zubehör; Alu, schwarz / Kunststoff, transparent  
accessoire; aluminium, noir / plastique, transparent

L 1000, B 17, H 20



9 002759 989378

### 98938 SURFACE PROFILE 3

accessory; aluminium, black / plastic, transparent  
Zubehör; Alu, schwarz / Kunststoff, transparent  
accessoire; aluminium, noir / plastique, transparent

L 2000, B 17, H 20



9 002759 989385

### 98939 SURFACE PROFILE 3

accessory; aluminium, anodised black  
Zubehör; Alu, schwarz eloxiert  
accessoire; aluminium, noir anodisé

L 110



9 002759 989392

### PROFILE CROSS-SECTION / Profilquerschnitt / section de profil

98931 98933 98938  
98932 98937 98939

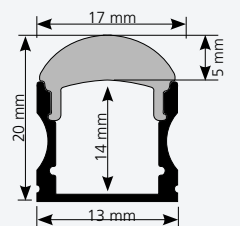

INCLUDED IN DELIVERY /  
im Lieferumfang enthalten /  
inclus dans la livraison



98934  
98935

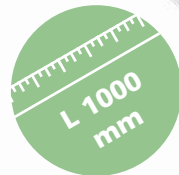

98934

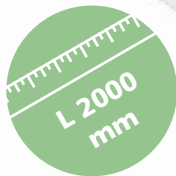

98935



98936

### 98934 SURFACE PROFILE 3

accessory; aluminium, white / plastic, transparent  
Zubehör; Alu, weiss / Kunststoff, transparent  
accessoire; aluminium, blanc / plastique, transparent

L 1000, B 17, H 20



9 002759 989347

### 98935 SURFACE PROFILE 3

accessory; aluminium, white / plastic, transparent  
Zubehör; Alu, weiss / Kunststoff, transparent  
accessoire; aluminium, blanc / plastique, transparent

L 2000, B 17, H 20



9 002759 989354

### 98936 SURFACE PROFILE 3

accessory; aluminium, white  
Zubehör; Alu, weiss  
accessoire; aluminium, blanc

L 110



9 002759 989361

# SURFACE PROFILES WITH 30° LINEAR LENS

incl. end caps & mounting clips



**PROFILE CROSS-SECTION /**  
Profilquerschnitt / section de profil

98934 98936  
98935

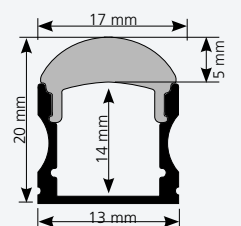



INCLUDED IN DELIVERY /  
im Lieferumfang enthalten /  
inclus dans la livraison



98941  
98942

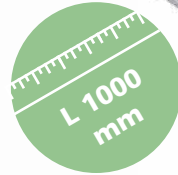

98941

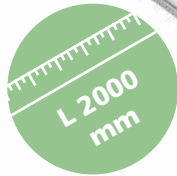

98942

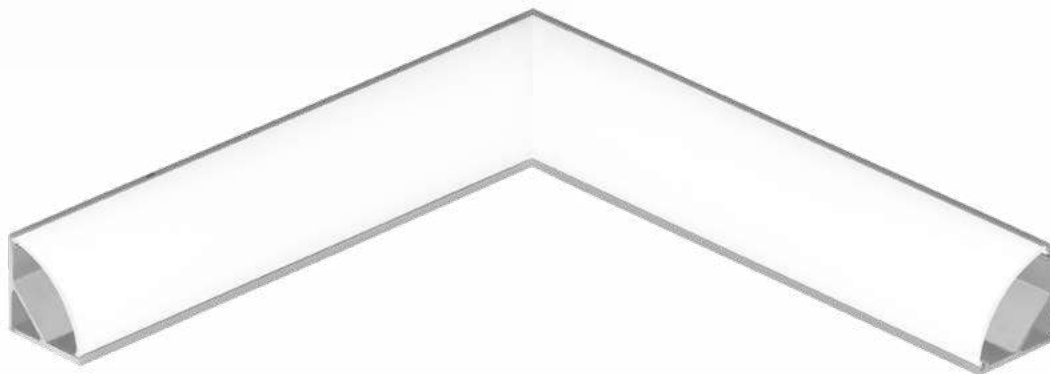

98943

### 98941 CORNER PROFILE 1

accessory; aluminium, aluminium / plastic, white  
Zubehör; Alu, alu / Kunststoff, weiss  
accessoire; aluminium, aluminium / plastique, blanc

L 1000, H 16



9 002759 989415

### 98942 CORNER PROFILE 1

accessory; aluminium, aluminium / plastic, white  
Zubehör; Alu, alu / Kunststoff, weiss  
accessoire; aluminium, aluminium / plastique, blanc

L 2000, H 16



9 002759 989422

### 98943 CORNER PROFILE 1

accessory; aluminium, aluminium  
Zubehör; Alu, alu  
accessoire; aluminium, aluminium

L 110



9 002759 989439

## CORNER PROFILES

incl. end caps & mounting clips



98944



**98944 CORNER PROFILE 1**

accessory; aluminium, aluminium  
Zubehör; Alu, alu  
accessoire; aluminium, aluminium

L 110



9 002759 989446

**PROFILE CROSS-SECTION /**  
Profilquerschnitt / section de profil

98941 98943  
98942 98944

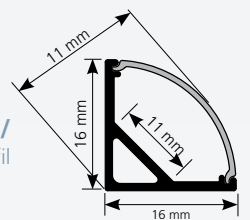

INCLUDED IN DELIVERY /

im Lieferumfang enthalten /  
inclus dans la livraison



98945  
98946

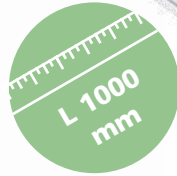

98945

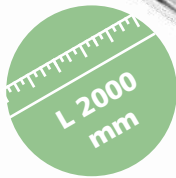

98946

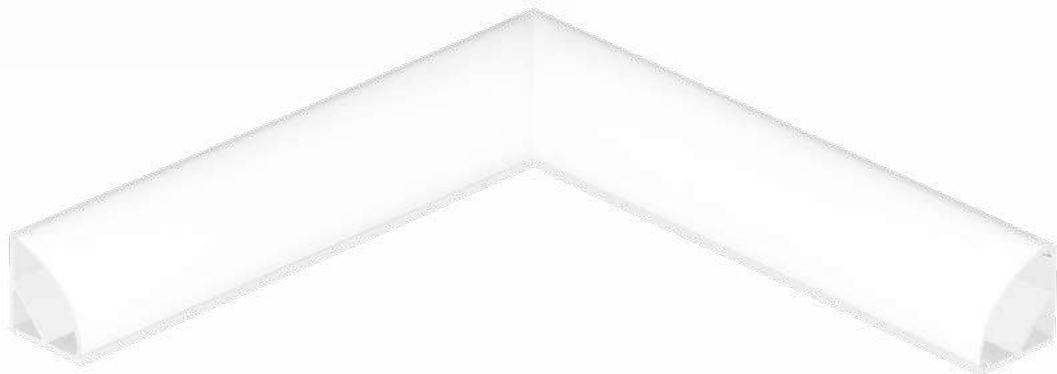

98947

### 98945 CORNER PROFILE 1

accessory; aluminium, white / plastic, white  
Zubehör; Alu, weiss / Kunststoff, weiss  
accessoire; aluminium, blanc / plastique, blanc

L 1000, H 16



9 002759 989453

### 98946 CORNER PROFILE 1

accessory; aluminium, white / plastic, white  
Zubehör; Alu, weiss / Kunststoff, weiss  
accessoire; aluminium, blanc / plastique, blanc

L 2000, H 16



9 002759 989460

### 98947 CORNER PROFILE 1

accessory; aluminium, white  
Zubehör; Alu, weiss  
accessoire; aluminium, blanc

L 110



9 002759 989477

## CORNER PROFILES

incl. end caps & mounting clips

PROFILE CROSS-SECTION /  
Profilquerschnitt / section de profil

98945 98947  
98946 98948

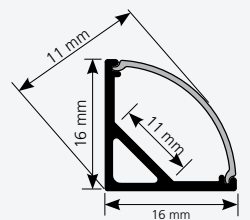

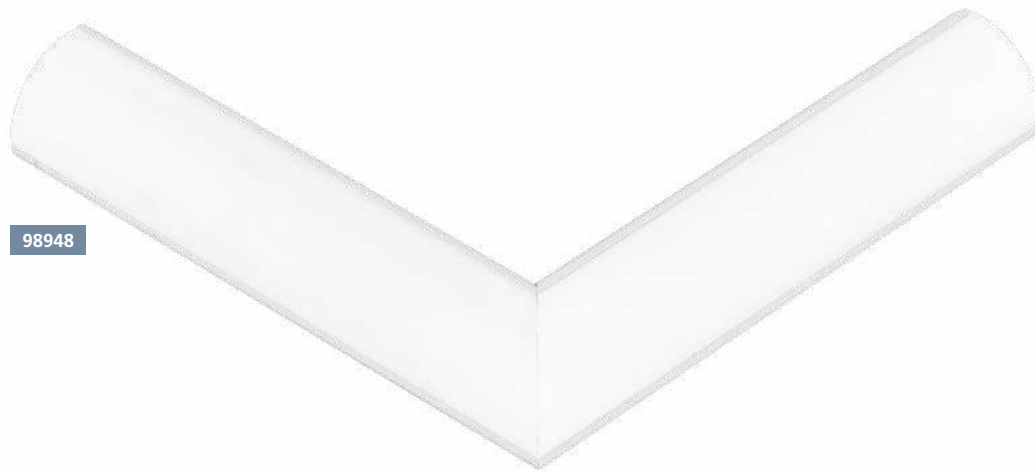

98948

### 98948 CORNER PROFILE 1

accessory; aluminium, white  
Zubehör; Alu, weiss  
accessoire; aluminium, blanc

L 110



9 002759 989484



INCLUDED IN DELIVERY /

im Lieferumfang enthalten /  
inclus dans la livraison



98949  
98951

98949

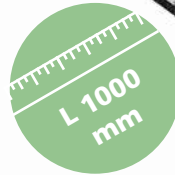

98951

98952

### 98949 CORNER PROFILE 1

accessory; aluminium, black / plastic, white  
Zubehör; Alu, schwarz / Kunststoff, weiss  
accessoire; aluminium, noir / plastique, blanc

L 1000, H 16



9 002759 989491

### 98951 CORNER PROFILE 1

accessory; aluminium, black / plastic, white  
Zubehör; Alu, schwarz / Kunststoff, weiss  
accessoire; aluminium, noir / plastique, blanc

L 2000, H 16



9 002759 989514

### 98952 CORNER PROFILE 1

accessory; aluminium, anodised black  
Zubehör; Alu, schwarz eloxiert  
accessoire; aluminium, noir anodisé

L 110



9 002759 989521

# CORNER PROFILES

incl. end caps & mounting clips

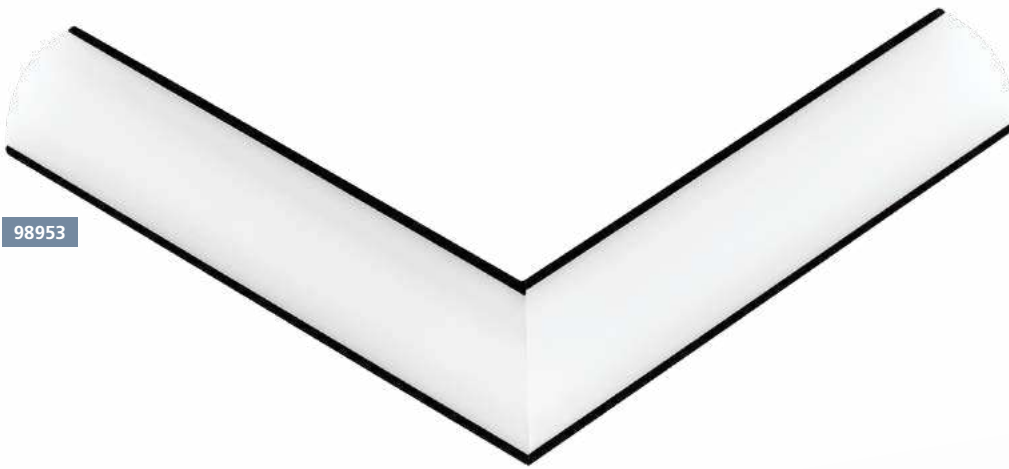

98953



### 98953 CORNER PROFILE 1

accessory; aluminium, anodised black  
Zubehör; Alu, schwarz eloxiert  
accessoire; aluminium, noir anodisé

L 110



9 002759 989538

### PROFILE CROSS-SECTION / Profilquerschnitt / section de profil

98949 98952  
98951 98953

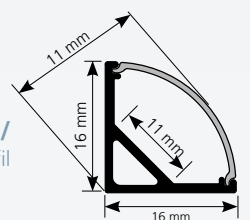



INCLUDED IN DELIVERY /

im Lieferumfang enthalten /  
inclus dans la livraison

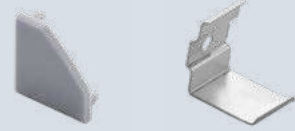

98954  
98955

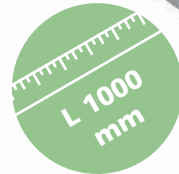

98954

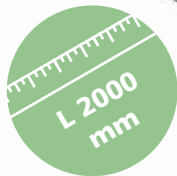

98955



98956

### 98954 CORNER PROFILE 2

accessory; aluminium, aluminium / plastic, white  
Zubehör; Alu, alu / Kunststoff, weiss  
accessoire; aluminium, aluminium / plastique, blanc

L 1000, B 18, H 18



9 002759 989545

### 98955 CORNER PROFILE 2

accessory; aluminium, aluminium / plastic, white  
Zubehör; Alu, alu / Kunststoff, weiss  
accessoire; aluminium, aluminium / plastique, blanc

L 2000, B 18, H 18



9 002759 989552

### 98956 CORNER PROFILE 2

accessory; aluminium, aluminium  
Zubehör; Alu, alu  
accessoire; aluminium, aluminium

L 110



9 002759 989569

## CORNER PROFILES

incl. end caps & mounting clips

PROFILE CROSS-SECTION /  
Profilquerschnitt / section de profil

98954 98956  
98955 98957

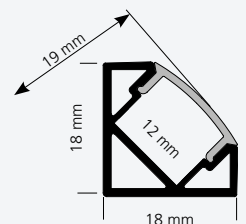

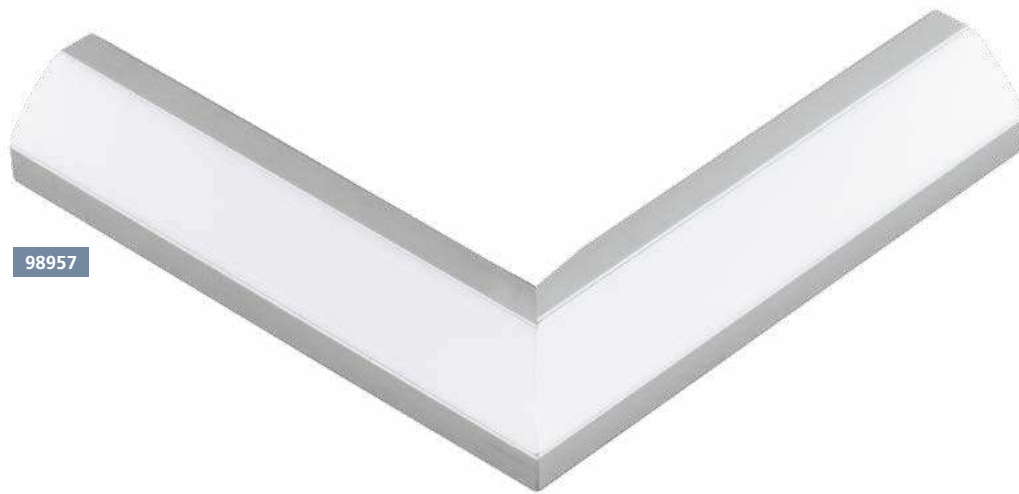

98957

### 98957 CORNER PROFILE 2

accessory; aluminium, aluminium  
Zubehör; Alu, alu  
accessoire; aluminium, aluminium

L 110



9 002759 989576



INCLUDED IN DELIVERY /

im Lieferumfang enthalten /  
inclus dans la livraison



98958  
98959



98958

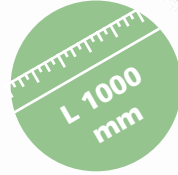

98959

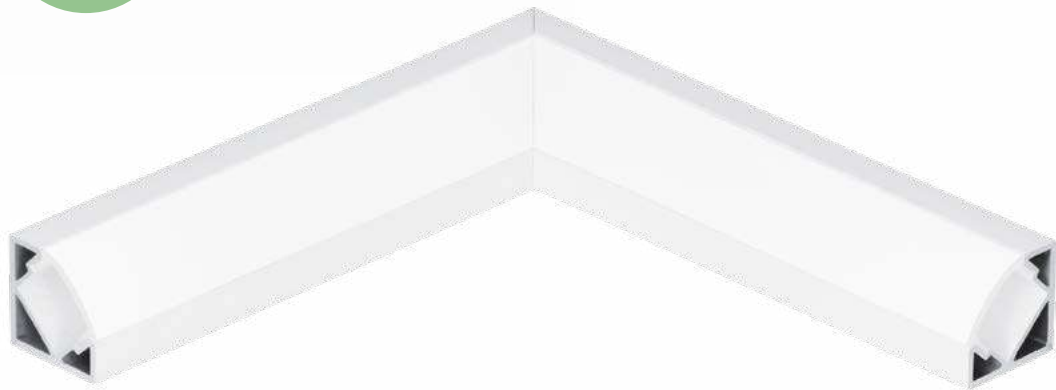
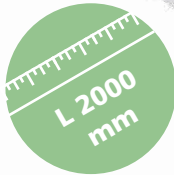

98961

### 98958 CORNER PROFILE 2

accessory; aluminium, white / plastic, white  
Zubehör; Alu, weiss / Kunststoff, weiss  
accessoire; aluminium, blanc / plastique, blanc

L 1000, B 18, H 18



9 002759 989583

### 98959 CORNER PROFILE 2

accessory; aluminium, white / plastic, white  
Zubehör; Alu, weiss / Kunststoff, weiss  
accessoire; aluminium, blanc / plastique, blanc

L 2000, B 18, H 18



9 002759 989590

### 98961 CORNER PROFILE 2

accessory; aluminium, white  
Zubehör; Alu, weiss  
accessoire; aluminium, blanc

L 110



9 002759 989613

## CORNER PROFILES

incl. end caps & mounting clips



98962

### 98962 CORNER PROFILE 2

accessory; aluminium, white  
Zubehör; Alu, weiss  
accessoire; aluminium, blanc

L 110



**PROFILE CROSS-SECTION /**  
Profilquerschnitt / section de profil

98958 98961  
98959 98962

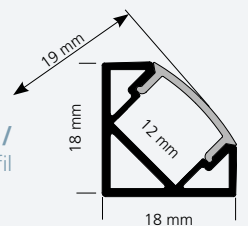

INCLUDED IN DELIVERY /  
im Lieferumfang enthalten /  
inclus dans la livraison



98963  
98964

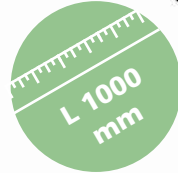

98963

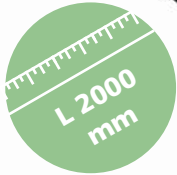

98964



98965

### 98963 CORNER PROFILE 2

accessory; aluminium, black / plastic, white  
Zubehör; Alu, schwarz / Kunststoff, weiss  
accessoire; aluminium, noir / plastique, blanc

L 1000, B 18, H 18



9 002759 989637

### 98964 CORNER PROFILE 2

accessory; aluminium, black / plastic, white  
Zubehör; Alu, schwarz / Kunststoff, weiss  
accessoire; aluminium, noir / plastique, blanc

L 2000, B 18, H 18



9 002759 989644

### 98965 CORNER PROFILE 2

accessory; aluminium, anodised black  
Zubehör; Alu, schwarz eloxiert  
accessoire; aluminium, noir anodisé

L 110



9 002759 989651

## CORNER PROFILES

incl. end caps & mounting clips

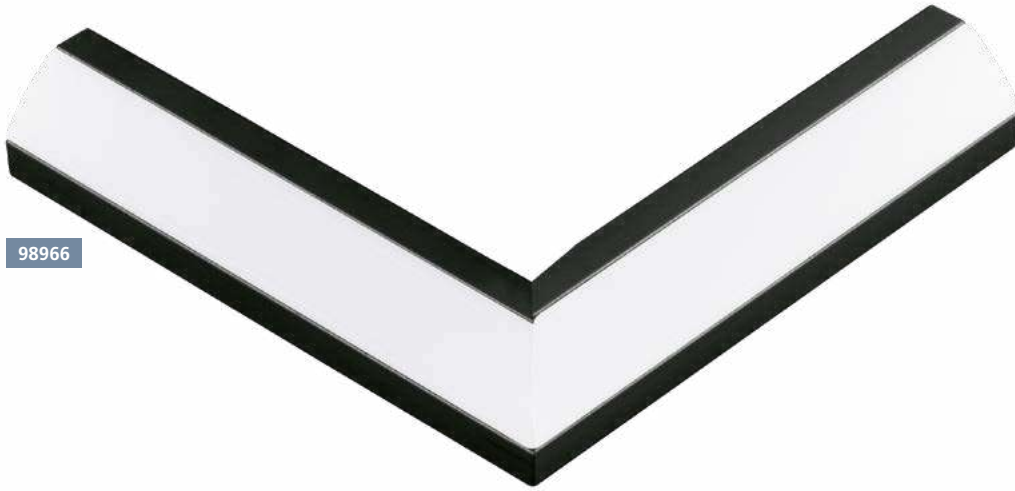

98966



### 98966 CORNER PROFILE 2

accessory; aluminium, anodised black  
Zubehör; Alu, schwarz eloxiert  
accessoire; aluminium, noir anodisé

L 110



9 002759 989668

### PROFILE CROSS-SECTION / Profilquerschnitt / section de profil

98963 98965  
98964 98966

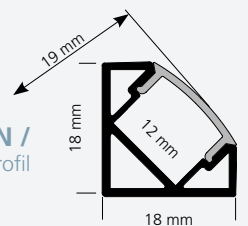



**INCLUDED IN DELIVERY /**

im Lieferumfang enthalten /  
inclus dans la livraison



98967  
98968



98971  
98972



98974  
98975

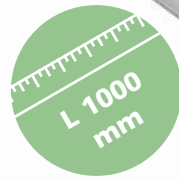

98967

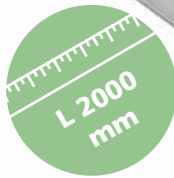

98968

98971

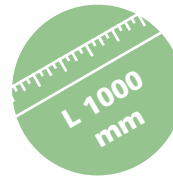

**98967 SURFACE PROFILE 4**

accessory; aluminium, aluminium / plastic, satined  
Zubehör; Alu, alu / Kunststoff, satiniert  
accessoire; aluminium, aluminium / plastique, satiné

L 1000, B 18, H 48



9 002759 989675

**98968 SURFACE PROFILE 4**

accessory; aluminium, aluminium / plastic, satined  
Zubehör; Alu, alu / Kunststoff, satiniert  
accessoire; aluminium, aluminium / plastique, satiné

L 2000, B 18, H 48



9 002759 989682

**98971 SURFACE PROFILE 4**

accessory; aluminium, white / plastic, satined  
Zubehör; Alu, weiss / Kunststoff, satiniert  
accessoire; aluminium, blanc / plastique, satiné

L 1000, B 18, H 48



9 002759 989712

# WALL CONSTRUCTION PROFILES

incl. end caps & mounting clips



98972



98974

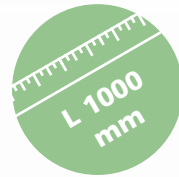

98975

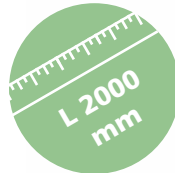

#### 98972 SURFACE PROFILE 4

accessory; aluminium, white / plastic, satiné  
Zubehör; Alu, weiss / Kunststoff, satiniert  
accessoire; aluminium, blanc / plastique, satiné

L 2000, B 18, H 48



9 002759 989729

#### 98974 SURFACE PROFILE 4

accessory; aluminium, black / plastic, satiné  
Zubehör; Alu, schwarz / Kunststoff, satiniert  
accessoire; aluminium, noir / plastique, satiné

L 1000, B 18, H 48



9 002759 989743

#### 98975 SURFACE PROFILE 4

accessory; aluminium, black / plastic, satiné  
Zubehör; Alu, schwarz / Kunststoff, satiniert  
accessoire; aluminium, noir / plastique, satiné

L 2000, B 18, H 48



9 002759 989750

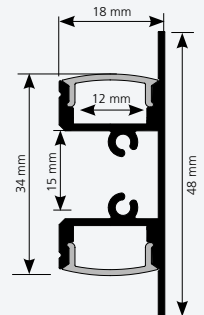

#### PROFILE CROSS-SECTION / Profilquerschnitt / section de profil

98967 98971 98974  
98968 98972 98975



98977

L 1000 mm



98978

L 2000 mm



98979

INCLUDED IN DELIVERY /  
im Lieferumfang enthalten /  
inclus dans la livraison



98977  
98978



98981  
98982

**98977 RECESSED PROFILE 1**  
accessory; aluminium, aluminium / plastic, white  
Zubehör; Alu, alu / Kunststoff, weiss  
accessoire; aluminium, aluminium / plastique, blanc

L 1000, B 23, H 9



9 002759 989774

**98978 RECESSED PROFILE 1**  
accessory; aluminium, aluminium / plastic, white  
Zubehör; Alu, alu / Kunststoff, weiss  
accessoire; aluminium, aluminium / plastique, blanc

L 2000, B 23, H 9



9 002759 989781

**98979 RECESSED PROFILE 1**  
accessory; aluminium, aluminium  
Zubehör; Alu, alu  
accessoire; aluminium, aluminium

L 110



9 002759 989798

# INSTALLATION PROFILES

incl. end caps & mounting clips



98981

L 1000  
mm



98982

L 2000  
mm



98983

### 98981 RECESSED PROFILE 1

accessory; aluminium, white / plastic, white  
Zubehör; Alu, weiss / Kunststoff, weiss  
accessoire; aluminium, blanc / plastique, blanc

L 1000, B 23, H 9



9 002759 989811

### 98982 RECESSED PROFILE 1

accessory; aluminium, white / plastic, white  
Zubehör; Alu, weiss / Kunststoff, weiss  
accessoire; aluminium, blanc / plastique, blanc

L 2000, B 23, H 9



9 002759 989828

### 98983 RECESSED PROFILE 1

accessory; aluminium, white  
Zubehör; Alu, weiss  
accessoire; aluminium, blanc

L 110



9 002759 989835

### PROFILE CROSS-SECTION / Profilquerschnitt / section de profil

98977 98979 98982  
98978 98981 98983

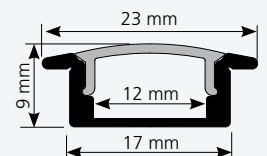

**INCLUDED IN DELIVERY /**  
im Lieferumfang enthalten /  
inclus dans la livraison



98984  
98985



98987  
98988

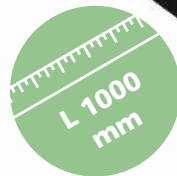

98984



98985



98986

### 98984 RECESSED PROFILE 1

accessory; aluminium, black / plastic, white  
Zubehör; Alu, schwarz / Kunststoff, weiss  
accessoire; aluminium, noir / plastique, blanc

L 1000, B 23, H 9



9 002759 989842

### 98985 RECESSED PROFILE 1

accessory; aluminium, black / plastic, white  
Zubehör; Alu, schwarz / Kunststoff, weiss  
accessoire; aluminium, noir / plastique, blanc

L 2000, B 23, H 9



9 002759 989859

### 98986 RECESSED PROFILE 1

accessory; aluminium, anodised black  
Zubehör; Alu, schwarz eloxiert  
accessoire; aluminium, noir anodisé

L 110



9 002759 989866

# INSTALLATION PROFILES

incl. end caps

## PROFILE CROSS-SECTION / Profilquerschnitt / section de profil

98984 98986  
98985

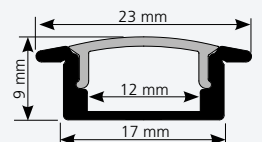



98987

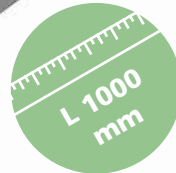

98988

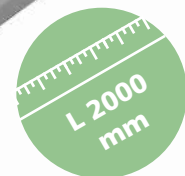

98989

### 98987 RECESSED PROFILE 2

accessory; aluminium, aluminium / plastic, white  
Zubehör; Alu, alu / Kunststoff, weiss  
accessoire; aluminium, aluminium / plastique, blanc

L 1000, B 23, H 15



9 002759 989873

### 98988 RECESSED PROFILE 2

accessory; aluminium, aluminium / plastic, white  
Zubehör; Alu, alu / Kunststoff, weiss  
accessoire; aluminium, aluminium / plastique, blanc

L 2000, B 23, H 15



9 002759 989880

### 98989 RECESSED PROFILE 2

accessory; aluminium, aluminium  
Zubehör; Alu, alu  
accessoire; aluminium, aluminium

L 110



9 002759 989897

### PROFILE CROSS-SECTION / Profilquerschnitt / section de profil

98987 98989  
98988

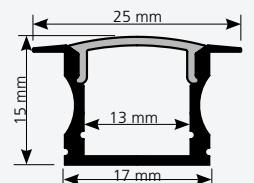



**INCLUDED IN DELIVERY /**

im Lieferumfang enthalten /  
inclus dans la livraison



98991  
98992



98994  
98995

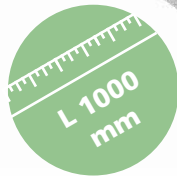

98991

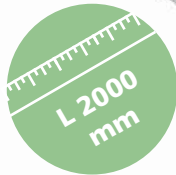

98992



98993

**98991 RECESSED PROFILE 2**

accessory; aluminium, white / plastic, white  
Zubehör; Alu, weiss / Kunststoff, weiss  
accessoire; aluminium, blanc / plastique, blanc

L 1000, B 23, H 15



9 002759 989910

**98992 RECESSED PROFILE 2**

accessory; aluminium, white / plastic, white  
Zubehör; Alu, weiss / Kunststoff, weiss  
accessoire; aluminium, blanc / plastique, blanc

L 2000, B 23, H 15



9 002759 989927

**98993 RECESSED PROFILE 2**

accessory; aluminium, white  
Zubehör; Alu, weiss  
accessoire; aluminium, blanc

L 110



9 002759 989934

# INSTALLATION PROFILES

incl. end caps



98994

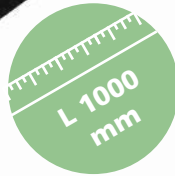

98995

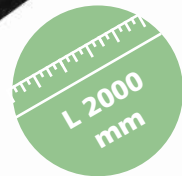

98996

### 98994 RECESSED PROFILE 2

accessory; aluminium, black / plastic, white  
Zubehör; Alu, schwarz / Kunststoff, weiss  
accessoire; aluminium, noir / plastique, blanc

L 1000, B 23, H 15



9 002759 989941

### 98995 RECESSED PROFILE 2

accessory; aluminium, black / plastic, white  
Zubehör; Alu, schwarz / Kunststoff, weiss  
accessoire; aluminium, noir / plastique, blanc

L 2000, B 23, H 15



9 002759 989958

### 98996 RECESSED PROFILE 2

accessory; aluminium, anodised black  
Zubehör; Alu, schwarz eloxiert  
accessoire; aluminium, noir anodisé

L 110



9 002759 989965

### PROFILE CROSS-SECTION / Profilquerschnitt / section de profil

98991 98993 98995  
98992 98994 98996

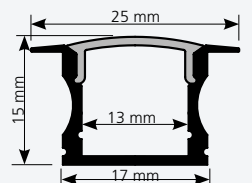

INCLUDED IN DELIVERY /  
im Lieferumfang enthalten /  
inclus dans la livraison



98997  
98998

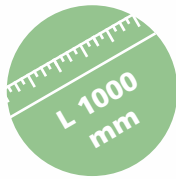

98997



98998

### 98997 SURFACE PROFILE 5

accessory; aluminium, aluminium / plastic, white  
Zubehör; Alu, alu / Kunststoff, weiss  
accessoire; aluminium, aluminium / plastique, blanc

L 1000, B 80, H 50



9 002759 989972

### 98998 SURFACE PROFILE 5

accessory; aluminium, aluminium / plastic, white  
Zubehör; Alu, alu / Kunststoff, weiss  
accessoire; aluminium, aluminium / plastique, blanc

L 2000, B 80, H 50



9 002759 989989

### PROFILE CROSS-SECTION / Profilquerschnitt / section de profil

98997  
98998

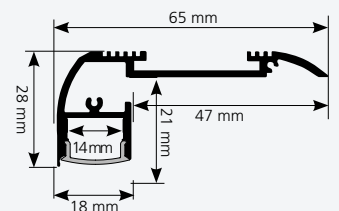

# TREPPENAUFBAU-PROFILE

incl. end caps





**INCLUDED IN DELIVERY /**  
im Lieferumfang enthalten /  
inclus dans la livraison



99004  
99005



99003  
99002

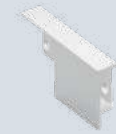

98999  
99001



99003

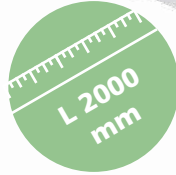

99002

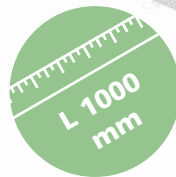

99005

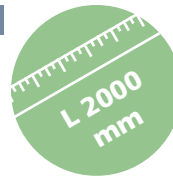

### 99003 RECESSED PROFILE 3

accessory; aluminium, white / plastic, white  
Zubehör; Alu, weiss / Kunststoff, weiss  
accessoire; aluminium, blanc / plastique, blanc

L 2000



9 002759 990039

### 99002 RECESSED PROFILE 3

accessory; aluminium, white / plastic, white  
Zubehör; Alu, weiss / Kunststoff, weiss  
accessoire; aluminium, blanc / plastique, blanc

L 1000



9 002759 990022

### 99005 RECESSED PROFILE 3

accessory; aluminium, black / plastic, white  
Zubehör; Alu, schwarz / Kunststoff, weiss  
accessoire; aluminium, noir / plastique, blanc

L 2000



9 002759 990053

# INSTALLATION PROFILES LARGE

incl. end caps

99004

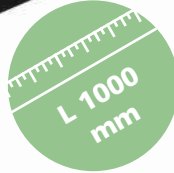

98999

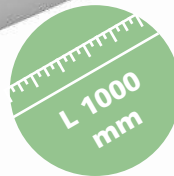

99001

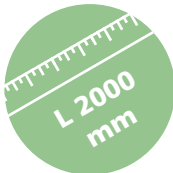

### 99004 RECESSED PROFILE 3

accessory; aluminium, black / plastic, white  
Zubehör; Alu, schwarz / Kunststoff, weiss  
accessoire; aluminium, noir / plastique, blanc

L 1000



9 002759 990046

### 98999 RECESSED PROFILE 3

accessory; aluminium, aluminium / plastic, white  
Zubehör; Alu, alu / Kunststoff, weiss  
accessoire; aluminium, aluminium / plastique, blanc

L 1000, B 65, H 45



9 002759 989996

### 99001 RECESSED PROFILE 3

accessory; aluminium, aluminium / plastic, white  
Zubehör; Alu, alu / Kunststoff, weiss  
accessoire; aluminium, aluminium / plastique, blanc

L 2000, B 65, H 45



9 002759 990015

### PROFILE CROSS-SECTION / Profilquerschnitt / section de profil

99001 99003 99005  
99002 99004 99006

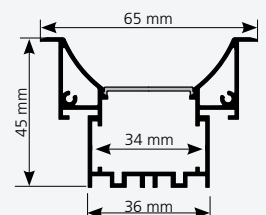





99006

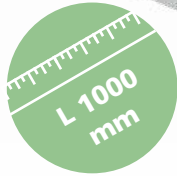

99007

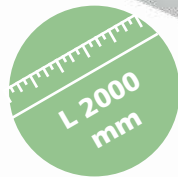

99008

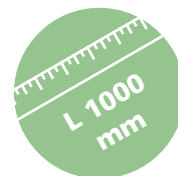

INCLUDED IN DELIVERY /  
im Lieferumfang enthalten /  
inclus dans la livraison



99006  
99007



99008  
99009



99011  
99012

### 99006 SURFACE PROFILE 6

accessory; aluminium, aluminium / plastic, white  
Zubehör; Alu, alu / Kunststoff, weiss  
accessoire; aluminium, aluminium / plastique, blanc

L 1000, B 35, H 45



9 002759 990060

### 99007 SURFACE PROFILE 6

accessory; aluminium, aluminium / plastic, white  
Zubehör; Alu, alu / Kunststoff, weiss  
accessoire; aluminium, aluminium / plastique, blanc

L 2000, B 35, H 45



9 002759 990077

### 99008 SURFACE PROFILE 6

accessory; aluminium, white / plastic, white  
Zubehör; Alu, weiss / Kunststoff, weiss  
accessoire; aluminium, blanc / plastique, blanc

L 1000, B 35, H 45



9 002759 990084

# INSTALLATION PROFILES LARGE

incl. end caps

99009



L 2000 mm

99011



L 1000 mm

99012



L 2000 mm

### 99009 SURFACE PROFILE 6

accessory; aluminium, white / plastic, white  
Zubehör; Alu, weiss / Kunststoff, weiss  
accessoire; aluminium, blanc / plastique, blanc

L 2000, B 35, H 45



9 002759 990091

### 99011 SURFACE PROFILE 6

accessory; aluminium, black / plastic, white  
Zubehör; Alu, schwarz / Kunststoff, weiss  
accessoire; aluminium, noir / plastique, blanc

L 1000, B 35, H 45



9 002759 990114

### 99012 SURFACE PROFILE 6

accessory; aluminium, black / plastic, white  
Zubehör; Alu, schwarz / Kunststoff, weiss  
accessoire; aluminium, noir / plastique, blanc

L 2000, B 35, H 45



9 002759 990121

### PROFILE CROSS-SECTION / Profilquerschnitt / section de profil

99006 99008 99011  
99007 99009 99012

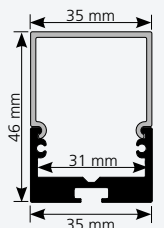

# ENERGY EFFICIENCY LABELS

ENERGIEEFFIZIENZ-LABEL

LABEL DE L'EFFICACITÉ ÉNERGÉTIQUE

---

**LED luminaires** - are increasingly popular and the demand for energy-efficient solutions is gaining strength. This has resulted in the adoption of several EU regulations prescribing the energy efficiency labelling of light sources and luminaires. We have prepared a brief overview of the new energy labels.

---

**LED Leuchtmittel** - sind am Vormarsch, der Ruf nach energieeffizienten Lösungen wird immer größer. In den letzten Jahren wurden daher mehrere EU-Verordnungen verabschiedet, die die Kennzeichnung der Energieeffizienz bei Leuchtmitteln und Leuchten vorschreibt. Hier finden Sie eine kurze Übersicht der neuen Energieeffizienz-kennzeichnung.



**Les éclairages LED** - gagnent du terrain, la demande de solutions efficaces en énergie ne cesse de croître. C'est la raison pour laquelle plusieurs directives européennes prescrivant le marquage de l'efficacité énergétique des moyens d'éclairage et des lampes ont été promulguées au cours de ces dernières années. Vous trouverez ici un bref aperçu d'ensemble des nouveaux marquages de l'efficacité énergétique.

---

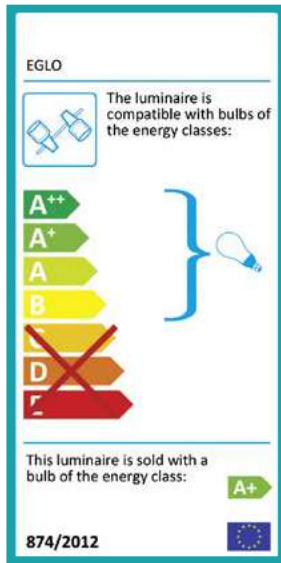

The information in brackets at the centre of the label indicates which bulbs may be used for the luminaire. In this case, the product is only compatible with bulbs with an energy efficiency rating of better than C.

Die Klammer in der Mitte des Labels gibt an, mit welchen Leuchtmitteln die Leuchte kompatibel ist. In diesem Fall dürfen nur Leuchtmittel verwendet werden, deren Energieklasse effizienter als C ist.

La parenthèse au milieu du label indique les moyens d'éclairage avec lesquels la lampe est compatible. Il est seulement permis dans ce cas d'utiliser des moyens d'éclairage dont la classe d'énergie présente une efficacité supérieure à C.

If bulbs are included with the luminaire, their energy classes are indicated at the bottom of the label.

Falls Leuchtmittel inkludiert sind, wird deren Energieklasse im unteren Teil des Labels angegeben.

Si des moyens d'éclairage sont inclus, leur classe énergétique est indiquée dans la partie inférieure du label.



This label indicates that no bulbs are included with the luminaire. Consumers are free to choose their preferred bulb within the indicated energy classes.

Dieses Label wird verwendet, wenn die Leuchte ohne Leuchtmittel ausgeliefert wird. Der Kunde kann selber entscheiden, welches Leuchtmittel der angegebenen Klassen verwendet wird.

Ce label est utilisé lorsque la lampe est livrée sans ampoules. Le client peut décider lui-même quel ampoule des classes indiquées est utilisé.

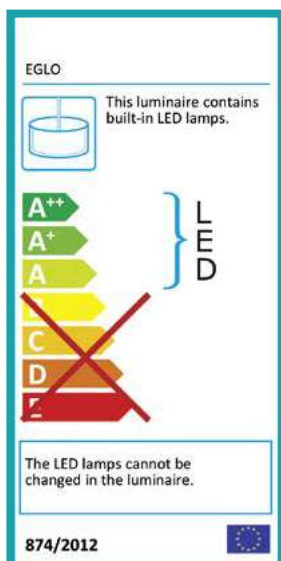

This label indicates that the luminaire is sold with built-in LED lamps that cannot be replaced by the consumer himself.

Dieses Label wird verwendet, wenn Leuchten mit LED-Modulen verkauft werden, die vom Endkunden nicht selbstständig ausgetauscht werden können.

Ce label est utilisé lorsque des lampes sont vendues avec des modules LED ne pouvant pas être changés par les clients finaux eux-mêmes.

## EEL BUTTONS

### bulbs included

inkl. Leuchtmittel | ampoules comprises



incl. highly efficient LED boards (cannot be replaced by the end consumer)

inkl. hocheffizienter LED Platinen (können nicht vom Endkonsumenten ausgetauscht werden)

incl. platines LED très efficaces (ne peuvent pas être remplacés par le consommateur final)



incl. highly efficient LED bulbs

inkl. hocheffizienter LED Leuchtmittel ampoules à LED plus efficaces comprises



incl. efficient LED and/or fluorescent bulbs

inkl. effizienter LED und/oder Leuchtstoff-Leuchtmittel

ampoules à LED et/ou fluorescentes efficaces comprises



incl. halogen bulbs

inkl. Halogen-Leuchtmittel

ampoules halogènes comprises

### bulbs not included

exkl. Leuchtmittel | ampoules non comprises



The luminaire is compatible with bulbs of all energy classes.

Die Leuchte ist mit Leuchtmitteln aller Energieklassen kompatibel.

compatible avec des ampoules de toutes les classes de l'énergie



The luminaire is only compatible with energy efficient bulbs.

Die Leuchte ist nur mit energieeffizienten Leuchtmitteln kompatibel.

compatible uniquement avec des ampoules économes en énergie

# EGLO WORLDWIDE

EGLO WELTWEIT  
EGLO DANS LE MONDE



 **HEADQUARTERS**  
EGLO LEUCHTEN GMBH  
Heiligkreuz 22  
A-6136 PILL  
T: +43 5242 6996 0 | F: +43 5242 6996 972  
E: info-austria@eglo.com

 **CANADA**  
EGLO CANADA INC.  
20700 Route Transcanadienne  
Baie-D'Urfé, Québec | H9X 4B7  
T: +1 514 457 5483 | F: +1 514 457 5487  
E: info-canada@eglo.com

 **CZECH REPUBLIC**  
EGLO CZ+SK s.r.o.  
Náchodská 2479/63  
CZ-193 00 PRAHA 9 Horní Počernice  
T: +420 281 924 163 | F: +420 281 925 205  
E: info-czechrepublic@eglo.com

 **AUSTRALIA**  
EGLO LIGHTING AUSTRALIA  
5/339 Archerfield Road  
Richlands | Queensland 4077  
T: +61 7 3375 1413 | F: +61 7 3375 1412  
E: info-australia@eglo.com

 **CHILE - SANTIAGO**  
EGLO CHILE ILUMINACION LTDA.  
Av. Américo Vespucio 1930  
Conchali - SANTIAGO DE CHILE  
T: +562 2 595 2222  
E: info-chile@eglo.com

 **DENMARK**  
EGLO DANMARK A/S  
Agerbakken 20  
DK-8362 Høring  
T: +45 70 22 55 11 | F: +45 70 22 55 21  
E: info-denmark@eglo.com

 **BELGIUM**  
EGLO BELGIUM B.V.B.A.  
Antwerpsesteenweg 247 | B-2950 Kapellen  
Visit Address: Innovatiepark 20 |  
4906 AA OOSTERHOUT (NL)  
T: +32 3 250 60 80 | F: +32 3 219 80 67  
E: info-belgium@eglo.com

 **CHINA**  
DONGGUAN EGLO CHINA LIGHTING CO., LTD.  
No.1 | Shangqiao Industrial Road | Shangqiao,  
Dongcheng District  
DONGGUAN CITY, GUANZHOU PROVINCE | CHINA  
T: +86 769 2203 3866 | F: +86 769 2203 6866  
E: info-china@eglo.com

 **ESTONIA**  
MOODNE VALGUSTUS AS  
Rävala pst. 7  
EE-10143 TALLINN  
T: +372 667 6670 | F: +372 631 3195  
E: info-global@eglo.com

 **BOSNIA-HERZEGOVINA**  
EGLO RASVJETA BH D.O.O.  
Ormanica bb  
BIH-76250 GRADACAC  
T: +387 35 86 85 00 | F: +387 35 82 44 41  
E: Info-Bosnia-Herzegovina@eglo.com

 **COLOMBIA**  
EGLO COLOMBIA ILUMINACION SAS  
AUTOPISTA NORTE KM 19 COSTADO LOTE 30  
BOGOTÁ - CHIA  
T: +57 (1) 744 2339  
E: info-global@eglo.com

 **FINLAND**  
EGLO FINLAND OY  
Malminraitti 17A  
00700 Helsinki  
T: +358 20 7649 820 | F: +358 20 7649 821  
E: info-finland@eglo.com

 **BRAZIL**  
EGLO DO BRASIL LUMINÁRIAS LTDA.  
Villa Lobos Office Park | Av. Queiroz Filho, 1.700,  
Torre D, Sala 1, Vila Hamburguesa - São Paulo - Brasil  
CEP: 05319-000, T: +55 11 4193 6980  
F: +55 11 2337-3921 | E: Info-Brazil@eglo.com

 **COSTA RICA**  
EGLO Costa Rica, Centro Comercial Calle Real local #8  
Guachipilín de Escazú de la sucursal del BAC  
San Jose 800 metros al norte San Jose Costa Rica.  
T: +506-2289-4690, +506-2100-6384  
E: Info-CostaRica@eglo.com

 **FRANCE**  
EGLO FRANCE LUMINAIRE SARL  
Z.A. Jeune Bois | 2 Rue de la Martinique  
F-68274 WITTENHEIM  
T: +33 389 6250 30 | F: +33 389 6250 49  
E: info-france@eglo.com

 **BULGARIA**  
EGLO BULGARIA EOOD  
Main Road Burgas-Sofia, 5th kilometer,  
Building KACHIKA, 8000 BOURGAS, Bulgaria  
T: +359 56 960 403 | F: +359 56 53 05 95  
E: info-bulgaria@eglo.com

 **CROATIA**  
EGLO RASVJETA D.O.O.  
Josipa Loncara 3  
HR-10000 ZAGREB  
T: +385 1 379 40 62 | F: +385 1 379 41 04  
E: info-croatia@eglo.com

 **GERMANY**  
EGLO LEUCHTEN HANDELS GMBH  
Kleinbahnstr. 35  
D-59759 ARNSBERG  
T: +49 2932 6269 0 | F: +49 2932 6269 39  
E: info-germany@eglo.com



**GREECE**  
**EGLO HELLAS A.E.**  
 Sykias 2 and parodos dekeleias  
 ACHARNAI, GR-13679  
 T: +30 210 240 77 10 | F: +30 210 240 07 29  
 E: info-greece@eglo.com



**MEXICO**  
**EGLO MÉXICO ILUMINACIÓN S DE RL DE CV**  
 Prolongación Avenida López Mateos Sur N°3561,  
 Fraccionamiento Los Gavilanes.  
 C.P. 45645, Tlajomulco de Zúñiga, Jalisco, México  
 T: +52 33 3687 20 95 | E: info-mexico@eglo.com



**SERBIA**  
**EGLO RASVETA DOO**  
 Stefana Prvovenčanog 28  
 11000 BEOGRAD | SRBIJA  
 T: +381 11 3981 366 | F: +381 11 3981 389  
 E: info-serbia@eglo.com



**GREAT BRITAIN**  
**EGLO UK LTD.**  
 Unit 12 Cirrus Park, Lower Farm Road, Moulton Park  
 Industrial Estate, NORTHAMPTON NN3 6UR  
 T: +44 1604 790 986 | F: +44 1604 670 282  
 E: info-greatbritain@eglo.com



**MIDDLE EAST**  
**EGLO LIGHTING MIDDLE EAST FZE**  
 P.O. BOX 262073, LOB 6, OFFICE G18  
 JEBEL ALI, DUBAI, UAE  
 T: +97 148810080 | F: +97 148810081  
 E: info.me@eglo.com



**SLOVAKIA**  
**EGLO CZ+SK s.r.o**  
 Náchodská 2479/63  
 CZ-193 00 PRAHA 9 Horní Počernice  
 T: +421 313 211 551 | F: +421 313 211 556  
 E: info-slovakia@eglo.com



**HUNGARY - PRODUCTION & LOGISTICS**  
**EGLO MAGYARORSZAG KFT.**  
 Fő út. 155  
 H-3060 PASZTO  
 T: + 36 32 560 050 | F: +36 32 560 040  
 E: info-hungary@eglo.com



**MOROCCO**  
**EGLO AFRICA**  
 219 Bd Med Zerkouni. Suite: 67  
 20330 CASABLANCA | Morocco  
 T: +212 522 98 80 25 / 05  
 E: info-global@eglo.com / info.africa@eglo.com



**SLOVENIA**  
**EGLO RASVJETA D.O.O.**  
 Josipa Lončara 3  
 HR-10000 ZAGREB  
 T: +386 158 093 18  
 E: info-slovenia@eglo.com



**INDIA**  
**EGLO INDIA PRIVATE LIMITED**  
 A-307 Ansal Chamber-1, 3 Bhikaji Cama Place,  
 New Delhi-110066  
 T: +91 981 108 2205 | F: +91 999 961 0450  
 E: info-india@eglo.com



**THE NETHERLANDS**  
**EGLO VERLICHTING NEDERLAND B.V.**  
 Innovatiepark 20  
 4906 AA OOSTERHOUT (NBR)  
 T: +31 162 48 28 30 | F: +31 162 48 28 40  
 E: Info-Netherland@eglo.com



**SPAIN**  
**EGLO ESPANA ILUMINACION S.L.**  
 Avda. de Castilla 1 (Edf. Best Point) 2°-16A  
 San Fernando de Henares, E-28830 MADRID  
 T: +34 91 677 9044 | F: +34 91 677 0304  
 E: info-spain@eglo.com



**ITALY**  
**EGLO ITALIANA S.R.L.**  
 Via Giotto, 4  
 I-31021 MOGLIANO VENETO (TV)  
 T: +39 041 45 66 232/245/251 | F: +39 041 45 74 066/071  
 E: info-italy@eglo.com



**NORWAY**  
**ELEKTRO-ARMATUR a.s**  
 Bjørnerudveien 18  
 N-1266 OSLO  
 T: +47 2262 9000 | F: +47 2262 9040  
 E: info-norway@eglo.com



**SWEDEN**  
**EGLO SVERIGE AB**  
 Honungsgatan 3  
 S-432 48 VARBERG  
 T: +46 340 623 505 | F: +46 340 623 605  
 E: info-sweden@eglo.com



**KAZAKHSTAN**  
**EGLO KAZAKHSTAN LLP**  
 Office 72, 14<sup>th</sup> floor, Block 4A, Nurlly-Tau Business Centr,  
 Al-Farabi Avenue 7, 050059 Almaty, Kazakhstan  
 T: +7 727 293 25 20 | M: +7 701 031 00 00  
 E: info-kazakhstan@eglo.com



**PERU**  
**EGLO PERU S.A.C**  
 Avda. Santa Cruz No. 458 Distrito de San Isidro  
 Provincia y Departamento Lima, San Isidro - Lima  
 T: +51 1 4212 158  
 E: info-peru@eglo.com



**SWITZERLAND**  
**EGLO SCHWEIZ AG**  
 Seetalstraße 142  
 CH-6032 EMMEN  
 T: +41 41 268 69 59 | F: +41 41 268 69 58  
 E: info-switzerland@eglo.com



**KOSOVO**  
**EGLO KOSOVA LLC**  
 Luginisht e qytetit pn  
 20000 PRIZREN- KOSOVO  
 T: +383 49 699 100 | Shop: +383 210 284  
 E: info-kosovo@eglo.com



**PHILIPPINES**  
**EGLO Lighting Pilipinas Corp.**  
 4/F One E-Com Center Building, Ocean Drive, Mall  
 of Asia Complex, Pasay City 1300 Philippines  
 T: +63 2 737 9419  
 E: info-global@eglo.com



**TURKEY**  
**Eglo Aydınlatma ithalat İhracat Ltd. Şti.**  
 Eyüp Sultan Mah. Sekmen Cad. No:18/2  
 34855 SAMANDIRA, SANCaktepe / İSTANBUL  
 T: +90 216 311 09 -02 / -03 / -04 | F: +90 216 311 09 -05  
 E: info-turkey@eglo.com



**LEBANON**  
**EGLO Lebanon S.A.R.L**  
 Damascus Road, Graizy Building - Basement No. 1  
 Aley city, Lebanon  
 T: +961 555 9125 | T: +961 555 9126  
 E: info-global@eglo.com



**POLAND**  
**EGLO POLSKA SP. Z.O.O.**  
 Ul. Pulawska 479  
 02-844 WARSZAWA  
 T: +48 22 644 57 55 | F: +48 22 644 89 82  
 E: info-poland@eglo.com



**USA**  
**EGLO USA, INC.**  
 3640 Royal South Parkway  
 ATLANTA, GEORGIA 30349  
 T: +1 404 477 5601 | F: +1 404 393 7053  
 E: info-usa@eglo.com



**LITHUANIA**  
**MOODNE VALGUSTUS AS**  
 Rāvala pst. 7  
 EE-10143 TALLINN  
 T: +370 652 49923 | T: +372 667 6670  
 E: info-lithuania@eglo.com



**PORTUGAL**  
**EGLO PORTUGAL ILUMINAÇÃO, LDA**  
 Rua Fonte Parada, 125  
 PT-4595-434 SEROA-PAÇOS DE FERREIRA  
 T: +351 255 890 000 | F: +351 255 892 346  
 E: info-portugal@eglo.com



**UKRAINE**  
**EGLO UKRAINE LTD**  
 bulv. Vatslav Havel 6/7A  
 UA-03680 KIEV  
 T: +38 044 463 98 41 | F: +38 044 468 84 67  
 E: info-ukraina@eglo.com



**MAGYARORSZÁG – ÉRTÉKESÍTÉS**  
**EGLO LUX KFT.**  
 Fő út. 143/A  
 H-2120 DUNAKESZI  
 T: +36 27 341 353 | F: +36 27 341 409  
 E: info-hungary@eglo.com



**ROMANIA**  
**EGLO ROMANIA PRODEXIM SRL.**  
 Str. Atomistilor nr. 1D  
 R-077125 MAGURELE - ILFOV - ROMANIA  
 T: +40 314 250 902 | F: +40 314 250 899  
 E: info-romania@eglo.com



**MALAYSIA**  
**EGLO ASIA SDN BHD**  
 No. 13, Jalan Pelukis U1/46B, Temasya 18, Glenmarie,  
 40150 Shah Alam, Selangor Darul Ehsan, Malaysia  
 T: +6011 1050 2336 | F: +603 5567 9415  
 E: info-malaysia@eglo.com



**RUSSIA**  
**EGLO LIGHTING LLC**  
 Varshavskoe shosse 35 | Building 1  
 RU-117105 | MOSCOW  
 T: +7495 789 4311 | F: +7495 789 4312  
 E: info-russia@eglo.com



# HOW TO READ

ERKLÄRUNG  
COMMENT LIRE

## DIMENSIONS DIMENSIONEN DIMENSIONS

all dimensions in mm | alle Größen in mm | toutes dimensions en mm

L = length | Länge | longueur

B = width | Breite | largeur

H = height | Höhe | hauteur

Ø = diameter | Durchmesser | diamètre

A = projection length | Ausladung | amplitude

ET = installation depth | Einbautiefe | profondeur utile

Base = base dimensions | Sockelmaße | dimensions de base

Attention! The dimensions relate solely to the sizes of the luminaire. Any air spaces that would be relevant for a safe operating of the lamp were not considered.

Achtung! Die Größen beziehen sich nur auf die Abmessungen der Leuchte. Etwaige Lufträume, die für einen sicheren Betrieb der Leuchte notwendig sind, werden nicht berücksichtigt.

Attention! Les dimensions se réfèrent à la taille de la lampe seulement. Espacements éventuels, que seraient importants pour une opération de la lampe sans danger, n'ont pas été considérés.

## BUTTONS BUTTONS BOUTONS

Bulb included | Leuchtmittel inkludiert | ampoules inclus



Recessed Luminaire | Einbauleuchte | luminaire encastrable



Surface Luminaire | Aufbauleuchte | luminaire en saillie



99131 FUEVA 5	99132 FUEVA 5	99133 FUEVA 5
recessed light; steel, white / plastic, white Einbauleuchte; Stahl, weiss / Kunststoff, weiss luminaire encastrable; acier, blanc / plastique, blanc	recessed light; steel, white / plastic, white Einbauleuchte; Stahl, weiss / Kunststoff, weiss luminaire encastrable; acier, blanc / plastique, blanc	recessed light; steel, white / plastic, white Einbauleuchte; Stahl, weiss / Kunststoff, weiss luminaire encastrable; acier, blanc / plastique, blanc
Ø 86, ET 26	Ø 117, ET 26	Ø 166, ET 26
LED, DIMMABLE, WHITE, 2.7W, 300lm, Ø 75	LED, DIMMABLE, WHITE, 5.5W, 650lm, Ø 105	LED, DIMMABLE, WHITE, 10.5W, 1200lm, Ø 155
9 002759 991319	9 002759 991326	9 002759 991333
Ø 86	Ø 117	Ø 166

122 | RECESSED LUMINAIRES FUEVA 5 STANDARD

ARTICLE NUMBER  
ARTIKELNUMMER  
NUMÉRO D'ARTICLE

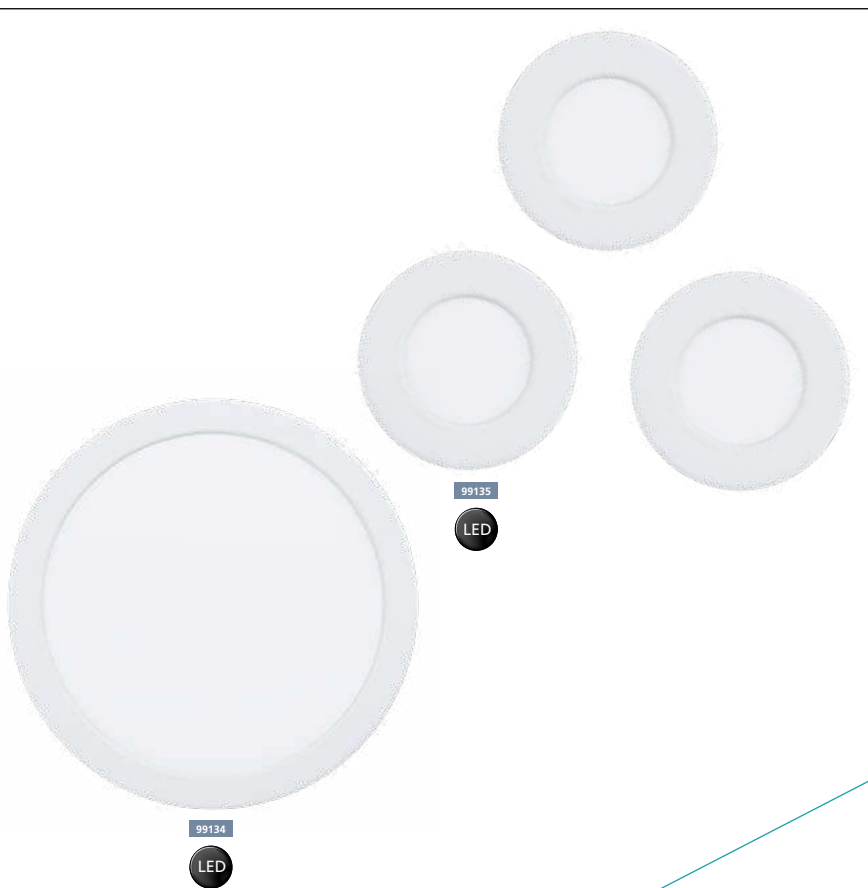

SPARE PARTS  
ERSATZTEILE  
PARTS DE REMPLACEMENT

If spare parts for product are available they are marked on the photograph with their corresponding article number.

Wenn zu einem Produkt Ersatzteile vorhanden sind, werden diese in der Abbildung mit der entsprechenden Artikelnummer markiert.

Si un produit a des parts de remplacement, elles sont marquées avec le numéro d'article dans la photo.

DESCRIPTION  
BESCHREIBUNG  
DESCRIPTION

The product description is composed as follows: luminaire type; enclosure material, enclosure colour / glass or shade material, glass or shade colour

Die Produktbeschreibung setzt sich wie folgt zusammen: Leuchtenart; Gehäusematerial, Gehäusefarbe / Schirm- bzw. Glasmaterial, Schirm- bzw. Glasfarbe

La description du produit est composée comme suit: type de luminaire; matériel de boîtier, couleur de boîtier / matériel de verre ou abat-jour, couleur de verre ou abat-jour

**99134 FUEVA 5**  
recessed light; steel, white / plastic, white  
Einbauleuchte; Stahl, weiss / Kunststoff, weiss  
luminaire encastrable; acier, blanc / plastique, blanc

Ø 216, ET 26  
LED  
16,5W 1800lm  
WHITE  
Ø 205



**99135 FUEVA 5**  
recessed light; steel, white / plastic, white  
Einbauleuchte; Stahl, weiss / Kunststoff, weiss  
luminaire encastrable; acier, blanc / plastique, blanc

Ø 86, ET 26  
LED  
3x 2,7W 300lm  
WHITE  
Ø 75



RECESSED LUMINAIRES FUEVA 5 STANDARD | 123

SERIES NAME  
SERIENNAME  
NOM DE LA SÉRIE

PICTOGRAMMES  
PIKTOGRAMME  
PICTOGRAMMES

Technical details are represented as pictograms. An overview over all pictograms can be found on the next pages.

Technische Details werden als Piktogramme dargestellt. Eine Übersicht über alle Piktogramme finden Sie auf den nächsten Seiten.

Les détails techniques sont représentés sous forme de pictogrammes. Vous trouverez un aperçu de tous les pictogrammes dans les pages suivantes.

SKETCHES  
SKIZZEN  
CROQUIS

The sketches state the most meaningful dimensions. If a product is adjustable by will, a turquoise arrow marks this function and only the maximum dimensions are indicated.



















Die Bemaßung der Skizzen umfasst jeweils die aussagekräftigsten Größen. Bei verstellbaren Produkten kennzeichnet ein türkiser Pfeil diese Funktion und nur die maximalen Größen werden angegeben.

Les dimensions des croquis comprennent les plus représentatives. Si un produit est réglable au choix, une flèche turquoise affiche cette fonction et rien que les dimensions maximales sont indiquées.























































# LEGEND

## PICTOGRAM PIKTOGRAMME PICTOGRAMME

### SOCKETS FASSUNGEN DOUILLES

 LED	 G4	 G53
 2G7	 G5	 GU5,3 / MR16
 2G11	 G9	 GU10
 2GX13	 G10Q	 GX53
 E14	 G13	 GY6,35
 E27	 G23	 R7s

### BULBS LEUCHTMITTEL AMPOULES

 E14 / C35	 E27 / A60 Halogen	 E27 / E140 Filament
 E14 / C35f	 E27 / R63 Halogen	 E27 / PS160 Filament
 E14 / D45	 E27 / A60 LED	 E27 / T30 Filament
 E14 / C35f LED	 E27 / A60 Filament	 E27 / T32 Filament
 E14 / D45 Halogen	 E27 / A65 LED	 G4 / T9
 E14 / C35 Halogen	 E27 / A75 Filament	 G4 / LT9
 E14 / T22	 E27 / G45 LED	 G4 / LT14
 E14 / C35 Filament	 E27 / G45 Filament	 G9
 E14 / C37 Filament	 E27 / G80 Filament	 G9 LED
 E14 / C35f Filament	 E27 / G95	 GU10
 E14 / C37f Filament	 E27 / G95 Filament	 GU10 LED
 E14 / P45 LED	 E27 / G125	 GU10 SMD LED
 E14 / P45 Filament	 E27 / G95 LED	 GX53 / LF75
 E14 / P50	 E27 / G200 Filament	<b>LED</b> LED board / LED Platine / LED bord
 E14 / ST48 Filament	 E27 / R63 LED	 MR16
 E14 / ST64 Filament	 E27 / ST48 Filament	 MR16 LED
 E14 / T20 LED	 E27 / ST64 Filament	 R7s / 78mm
 E27 / A60	 E27 / B80 Filament	 R7s / 118mm
 E27 / G90	 E27 / BR150 Filament	 R7s / 78mm LED
 E27 / QR63	 E27 / DP165 Filament	 R7s / 118mm LED

**LIGHT COLOUR & LUMEN**  
**LICHTFARBE & LUMEN**  
**COULEUR LUMINEUX & LUMEN**

The colours of the LED are represented as pictogrammes (see below), their luminous flux directly beneath. The luminous flux is quoted in lumen and describes the amount of light generated by the LED. The higher the value, the brighter is the lamp. Lumens are LED boards and are the light measurement value in bulbs.

Die Farben der LED werden als Piktogramm (siehe unten) dargestellt, deren Lichtstrom direkt darunter. Der Lichtstrom wird in Lumen gemessen und gibt die erzeugte Lichtmenge der LED an. Je höher der Wert, desto heller das Produkt. Lichtstromangaben (Lumen) sind Platinen- bzw. Leuchtmittelwerte.

Les couleurs de LED ont représentés sous forme de pictogrammes, leur flux lumineux directement en dessous. L'unité de flux lumineux est le lumen et il mesure la quantité de lumière générée par les LED. Plus la valeur est élevée, plus la lampe est lumineuse. Les lumens sont l'unité de mesure de l'intensité lumineuse des ampoules et des panneaux led intégrés.

	RGB RGB RGB		RGB + tunabel white RGB + tunabel white RGB + tunabel white
	RGB + white RGB + weiß RGB + blanc		tunable white tunable white tunable white
	RGB + warmwhite RGB + warmweiß RGB + blanc chaud		warm white warmweiß blanc chaud
	RGB + coldwhite RGB + kaltweiß RGB + blanc froid		cold white kaltweiß blanc froid
	RGB + neutralwhite RGB + neutralweiß RGB + blanc neutral		neutral white neutralweiß blanc neutre

**SWITCHES & SENSORES**  
**SCHALTER & SENSOREN**  
**INTERRUPTEUR & CAPTEURS**

	incl. cable & plug inkl. Kabel & Stecker câble & connecteur inclus		pedal switch Trittschalter interrupteur à pied		swedish plug Stecker Schweden connecteur swede
	internal dimmer eingebauter Dimmer variateur intégré		cable switch Kabelschalter interrupteur à câble		"Touch me" ON/OFF "Touch me" EIN/AUS "Touch me" ON/OFF
	button switch Druckknopf interrupteur de pression		incl. cable & plug transformer inkl. Kabel & Stecktransformator câble & transformateur à prise		"Touch me" ON/OFF & dimm "Touch me" EIN/AUS & Dimmen "Touch me" ON/OFF & graduable
	function switch Funktionsschalter interrupteur fonction		remote control Fernbedienung télécommande		pull switch Zugschalter interrupteur à bascule
	rocker switch Wippschalter interrupteur à bascule		Day & Night Sensor Tag & Nacht Sensor sensor jour & nuit		Timer - automatic on/off Zeitschaltuhr - automatisches Ein- & Ausschalten minuterie - peut être éteint et allumé automatiquement
	pedal dimmer Trittdimmer variateur à pied		sensor Sensor sensor		

**FUNKTIONEN & KOMFORT**  
**FUNKTIONEN & KOMFORT**  
**FONCTIONS & COMFORT**

	incl. battery inkl. Akku incl. pile		cutout (in mm) Ausschnitt (in mm) perçage du panneau (en mm)		packaging / delivery unit Verpackungs- / Liefereinheit unité d'emballage / de livraison
	incl. battery inkl. Batterie incl. pile		dimmable dimmbar mit externen Dimmer graduable		shortable kürzbar réductible
	battery specifications Batteriespezifikationen spécifications des piles		not dimmable nicht dimmbar ne pas graduable		Voltage Volt Voltage
	beam angle Ausstrahlwinkel angle de rayonnement		Can be operated via control unit Bedienbar über Steuergerät Peut être commandé par une unité de contrôle		Watt
	corner mount possible Eckmontage möglich montage en coin possible		replaceable LED austauschbare LED LED remplaçables		USB connection USB-Anschluss Connexion USB
	Colour Rendering Index		loadable in kg belastbar in kg chargeable en kg		Qi-Charger

**PROTECTION CLASS**  
**SCHUTZKLASSE**  
**CLASSE DE PROTECTION**

The protection class indicates to what extent the lamp is protected against electric shock. All lamps in this catalogue are at least protected with the protection class 1 - a higher class is specified in the information box of the respective lamp.

Die Schutzklasse gibt an, inwiefern ein Produkt gegen einen elektrischen Schlag gesichert ist. Alle Leuchten in diesem Katalog sind mit mindestens Schutzklasse 1 gesichert, bei höheren Klassen wird das Symbol im Infokasten der Leuchte angegeben.

La classe de protection indique, dans quelle mesure la lampe est protégée contre les chocs électriques. Tous les lampes dans ce catalogue sont protégées au moins avec la classe 1 - une classe plus élevée est indiquée dans l'information de la lampe.

	protection class 1: protective earthing Schutzklasse 1: Schutzerdung classe de protection 1: prise de terre		protection class 2: protective insulation Schutzklasse 2: Schutzisolierung classe de protection 2: double isolation ou renforcée		protection class 3: protective low voltage Schutzklasse 3: Schutzkleinspannung classe de protection 3: très basse tension de sécurité
--	-------------------------------------------------------------------------------------------------------------------	--	----------------------------------------------------------------------------------------------------------------------------------------	--	---------------------------------------------------------------------------------------------------------------------------------------------

**PROTECTION RATING**  
**SCHUTZGRAD**  
**INDICE DE PROTECTION**

The protection rating ensures the operational safety of luminaires. The first number specifies the extent of the protection against the ingress of foreign bodies; the second number identifies the humidity protection grade. All luminaires in this catalogue are at least protected with the rating IP20 - a higher rating is specified in the information box of the luminaire.

Der Schutzgrad gewährleistet die Betriebssicherheit von Leuchten. Die erste Ziffer des IP Grades beschreibt den Schutzzumfang gegen das Eindringen von Fremdkörpern, die zweite Ziffer informiert über den Grad des Feuchtigkeitsschutzes. Alle Leuchten in diesem Katalog sind mit mindestens Schutzgrad IP20 gesichert, bei höheren Graden wird das Symbol im Infokasten der Leuchte angegeben.

L'indice de protection assure la sécurité opérationnelle des luminaires. Le premier chiffre indique à quel point la protection est efficace contre l'insertion de corps étrangers; le second chiffre indique quant à lui le degré de protection par rapport à l'humidité. Tous les luminaires dans ce catalogue sont protégés au moins avec l'indice IP20 - un indice plus élevé est indiqué dans l'information d'article.

	IP33		IP44		IP54		IP65		IP67
--	------	--	------	--	------	--	------	--	------

# NOTES

NOTIZEN  
NOTES

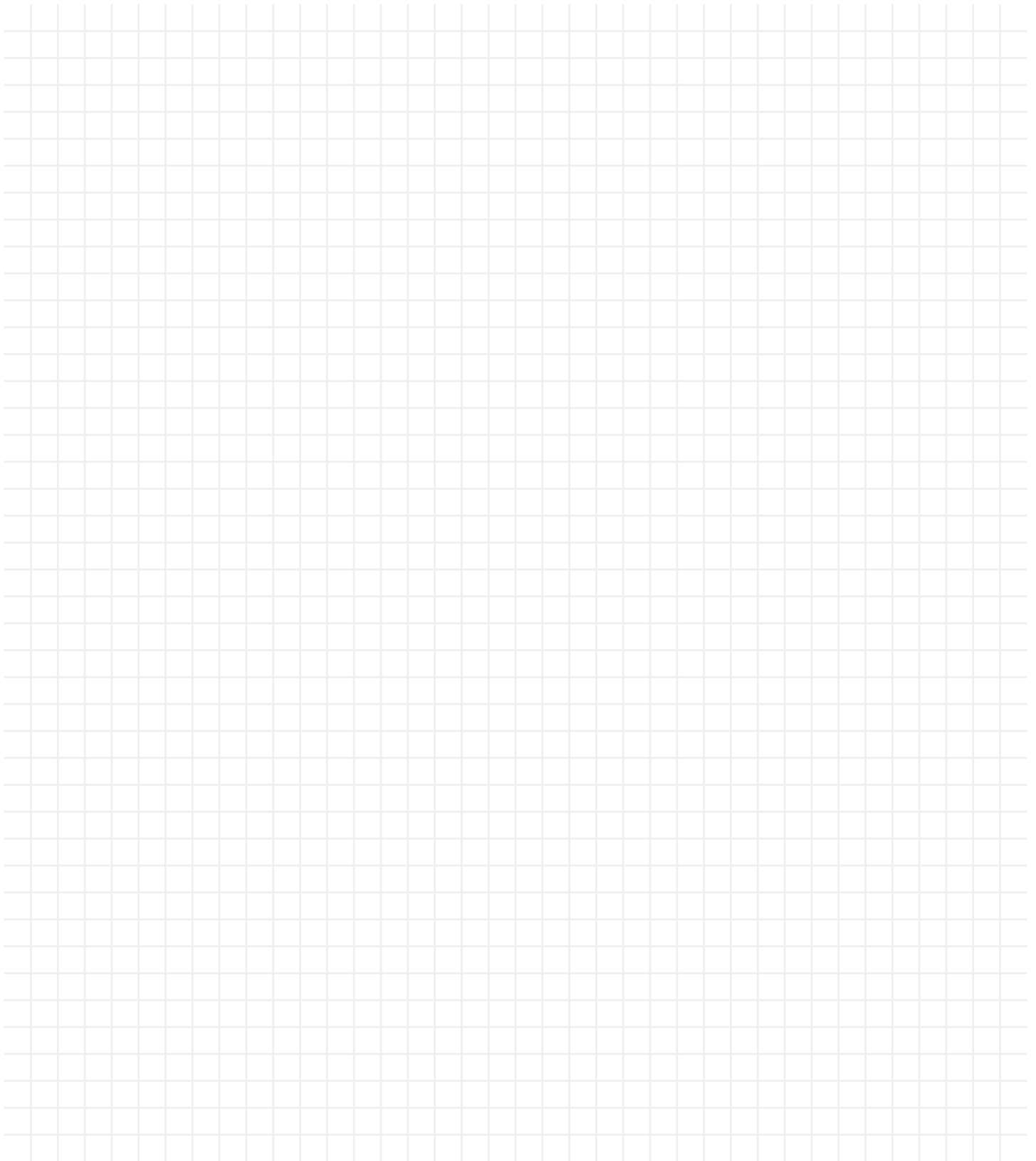

# NOTES

NOTIZEN  
NOTES

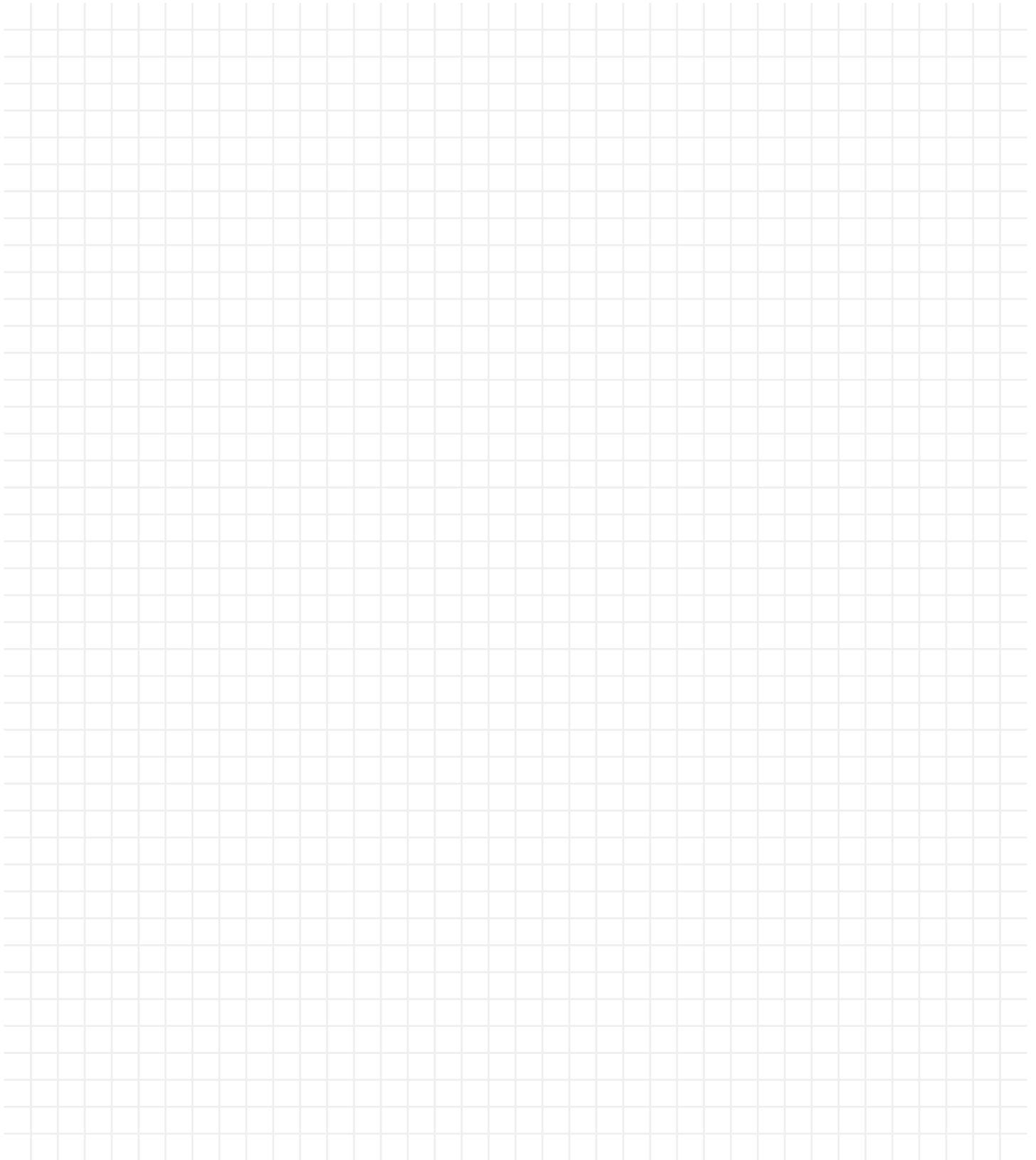



# NOTES

NOTIZEN  
NOTES

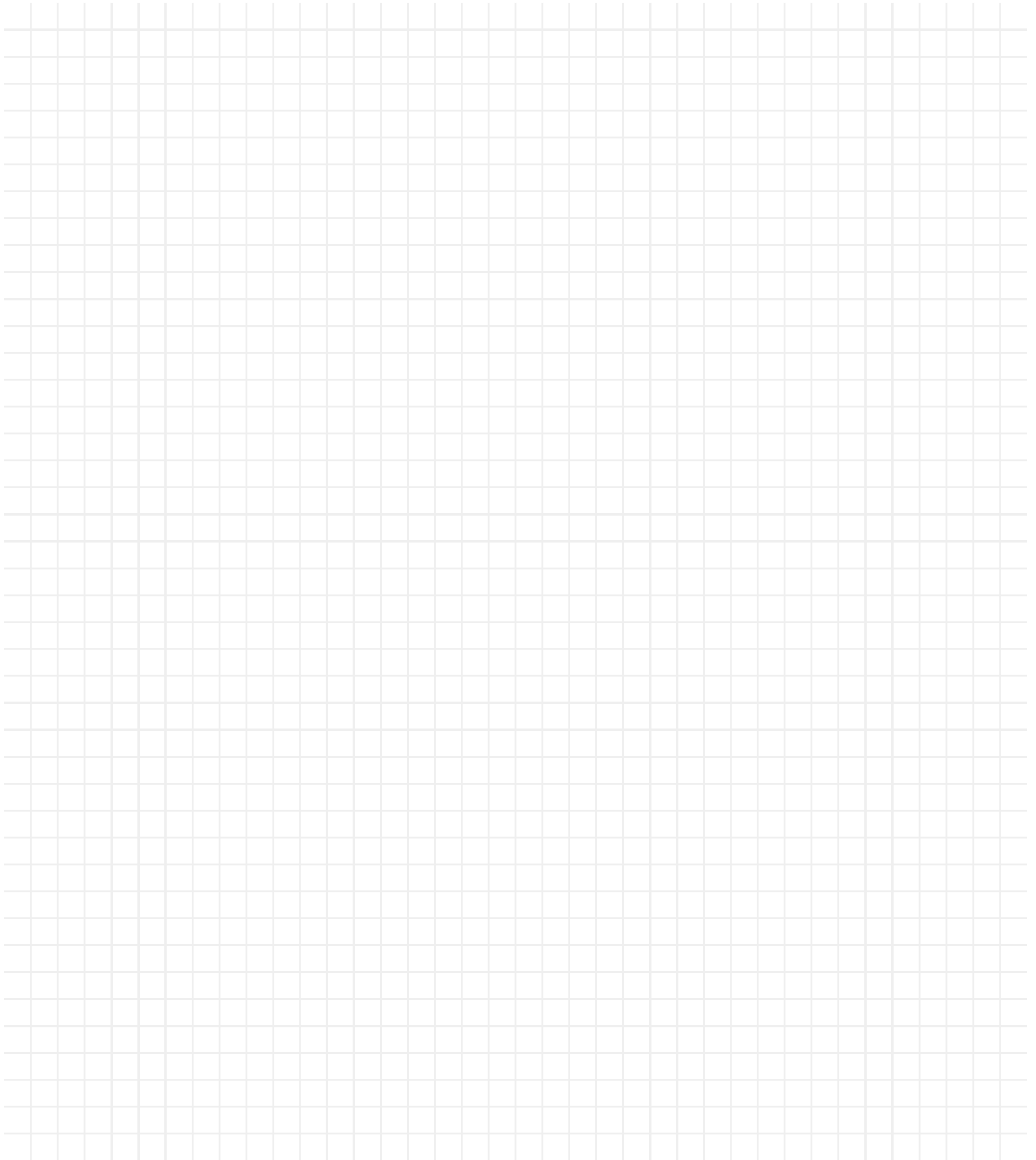

# NOTES

NOTIZEN  
NOTES

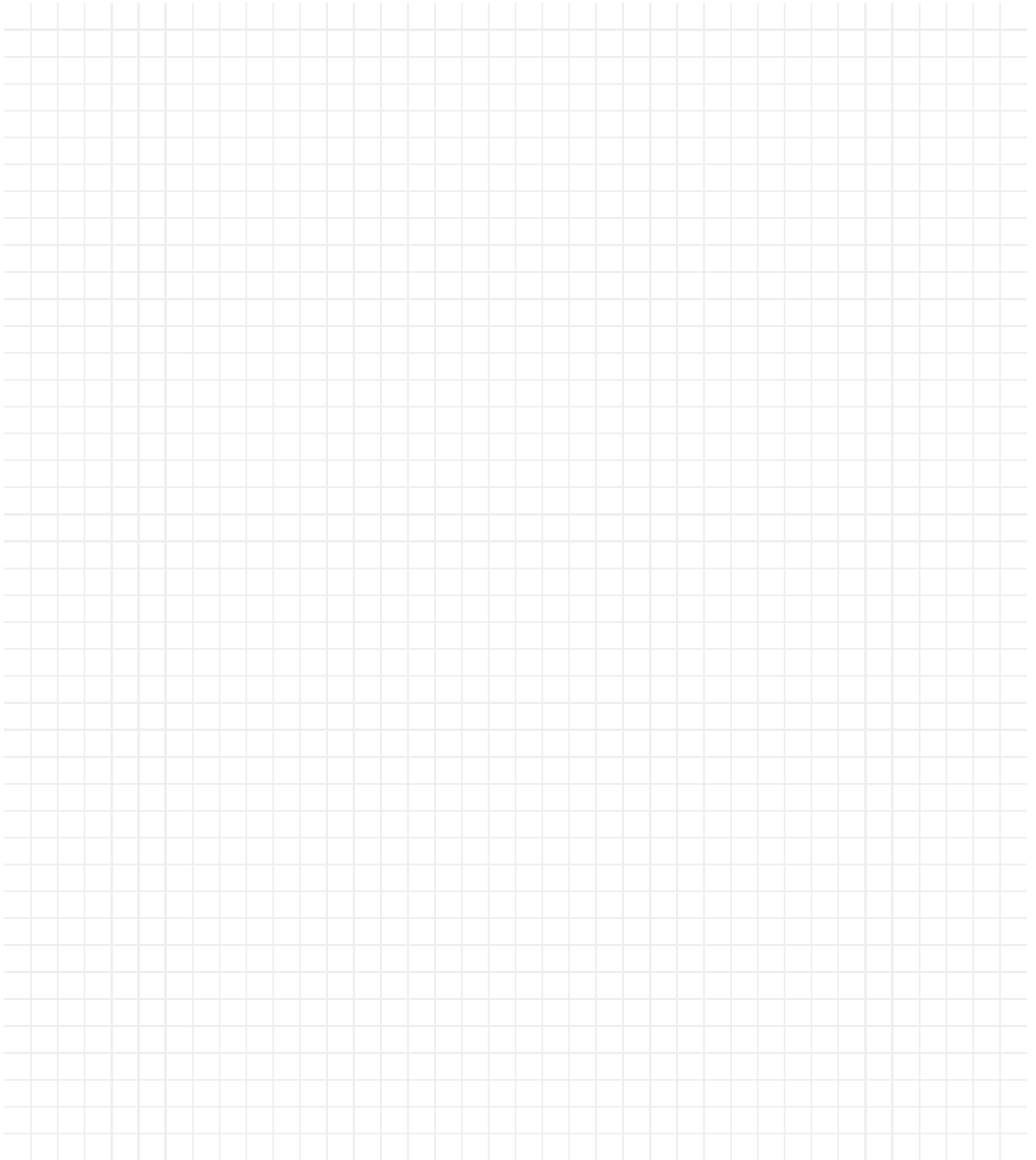

# REGISTER

ARTICLE NUMBER  
ARTIKELNUMMER  
NUMÉROS D'ARTICLE

NUMBER NUMMER NUMÉRO	PAGE SEITE PAGE	NUMBER NUMMER NUMÉRO	PAGE SEITE PAGE	NUMBER NUMMER NUMÉRO	PAGE SEITE PAGE	NUMBER NUMMER NUMÉRO	PAGE SEITE PAGE	NUMBER NUMMER NUMÉRO	PAGE SEITE PAGE	NUMBER NUMMER NUMÉRO	PAGE SEITE PAGE	NUMBER NUMMER NUMÉRO	PAGE SEITE PAGE
31682	168	94502	210	96671	32	97592	152	98303	106	98902	70	98957	253
31683	168	94503	211	96672	33	97593	152	98304	108	98903	70	98958	254
31688	168	94504	210	96673	33	97594	153	98305	107	98904	71	98959	254
31689	169	95357	172	96676	30	97629	24	98306	109	98905	71	98961	254
32732	22	95359	173	96677	34	97925	227	98307	107	98911	236	98962	255
32733	38	95362	169	96678	34	97926	227	98308	109	98912	236	98963	256
32737	28	95817	112	96679	35	97927	228	98418	76	98913	236	98964	256
32738	28	95818	112	96681	35	97928	228	98419	76	98914	237	98965	256
32741	38	95819	112	96791	214	97929	226	98471	104	98915	237	98966	257
32753	30	95821	113	96792	214	97931	226	98472	104	98916	237	98967	258
32754	30	95822	113	96793	214	97958	22	98473	104	98917	238	98968	258
32811	75	95823	113	96794	215	97959	22	98474	105	98918	238	98971	258
32812	74	95841	96	96891	84	97961	23	98475	68	98919	238	98972	259
32813	74	95843	97	96892	84	98025	75	98476	68	98921	239	98974	259
32881	29	95844	96	96893	84	98026	85	98477	68	98922	239	98975	259
32882	31	95846	97	96894	85	98036	86	98478	69	98923	239	98977	260
32896	98	95847	94	96901	118	98037	86	98479	69	98924	240	98978	260
33107	88	95848	94	96902	118	98038	86	98485	81	98925	240	98979	260
33108	88	95849	94	97029	230	98039	87	98521	150	98926	240	98981	261
33199	46	95851	95	97079	154	98089	25	98522	150	98927	241	98982	261
61355	64	95852	95	97262	198	98129	74	98559	36	98928	241	98983	261
61358	64	95853	95	97263	199	98201	48	98561	36	98929	241	98984	262
61359	65	95854	100	97264	202	98203	48	98562	20	98931	242	98985	262
61361	65	95855	100	97265	203	98205	49	98563	20	98932	242	98986	262
61489	64	95856	100	97266	200	98206	49	98564	20	98933	242	98987	263
91352	220	95857	101	97267	200	98207	46	98565	21	98934	244	98988	263
91353	220	95858	101	97268	204	98208	46	98566	23	98935	244	98989	263
91354	220	95859	101	97269	204	98209	47	98571	224	98936	244	98991	264
91355	221	95887	114	97271	198	98212	51	98572	224	98937	243	98992	264
92051	231	95888	114	97272	199	98214	83	98573	224	98938	243	98993	264
94235	163	95889	114	97273	202	98215	83	98574	225	98939	243	98994	265
94236	163	95917	116	97274	203	98238	110	98575	21	98941	246	98995	265
94237	163	95918	116	97275	200	98239	110	98607	102	98942	246	98996	265
94239	164	95932	117	97276	201	98241	110	98609	106	98943	246	98997	266
94241	165	95962	116	97277	204	98242	111	98611	108	98944	247	98998	266
94242	164	96151	63	97278	205	98243	102	98636	160	98945	248	98999	269
94243	166	96152	62	97279	198	98244	102	98637	161	98946	248	99001	269
94262	166	96153	62	97282	202	98245	103	98638	160	98947	248	99002	268
94406	164	96154	62	97501	80	98246	103	98639	160	98948	249	99003	268
94407	165	96616	173	97502	80	98292	51	98641	170	98949	250	99004	269
94408	165	96617	173	97503	80	98293	51	98642	170	98951	250	99005	268
94496	212	96662	24	97504	82	98295	52	98643	170	98952	250	99006	270
94497	212	96663	24	97505	82	98296	52	98644	162	98953	251	99007	270
94498	212	96664	25	97552	199	98297	48	98645	162	98954	252	99008	270
94499	213	96668	28	97553	203	98301	106	98646	162	98955	252	99009	271
94501	210	96669	32	97591	152	98302	108	98901	70	98956	252	99011	271

NUMBER NUMMER NUMÉRO	PAGE SEITE PAGE	NUMBER NUMMER NUMÉRO	PAGE SEITE PAGE	NUMBER NUMMER NUMÉRO	PAGE SEITE PAGE
99012	271	99183	137	99244	186
99038	58	99184	137	99245	186
99039	58	99185	137	99246	188
99061	158	99187	139	99247	188
99062	158	99188	139	99248	188
99065	216	99189	139	99252	189
99066	216	99191	141	99253	189
99118	18	99192	141	99254	189
99119	18	99193	141	99255	190
99121	18	99202	142	99256	190
99131	122	99203	142	99257	190
99132	122	99204	144	99258	192
99133	122	99205	144	99259	192
99134	123	99206	142	99263	192
99135	123	99207	143	99264	193
99136	124	99208	144	99265	194
99137	124	99209	145	99266	194
99138	124	99211	146	99267	194
99139	125	99212	146	99268	196
99141	125	99213	146	99269	196
99142	126	99214	147	99271	196
99143	126	99215	177	99281	218
99144	126	99216	177	99282	218
99145	127	99217	177	99283	218
99146	127	99218	178	99284	219
99147	128	99219	178	99337	208
99148	128	99221	178	99338	208
99149	128	99222	179	99411	16
99151	129	99223	179	99412	16
99152	130	99224	179	99414	27
99153	130	99225	180	99415	26
99154	130	99226	180	99416	26
99155	131	99227	180	99417	26
99156	132	99228	181	99418	27
99157	132	99229	181		
99158	132	99232	181		
99159	133	99233	182		
99162	134	99234	182		
99163	134	99235	182		
99164	134	99236	184		
99167	135	99237	184		
99168	135	99238	184		
99169	135	99239	185		
99178	136	99241	185		
99179	136	99242	185		
99181	136	99243	186		

# REGISTER

SERIES NAMES  
SERIENNAMEN  
NOME DE PRODUITS

NAME NAME NOM	PAGE SEITE PAGE	NAME NAME NOM	PAGE SEITE PAGE
ACCESS REMOTE	46	SALITERAS-C	16
AREITIO	160-161	SALOBRENA 1	62-65,74-75
CHANGO	154	SALOBRENA 2	84-87
CONNECT REMOTE	22	SALOBRENA-A	48-49
CORNER PROFILE 1	246-251	SALOBRENA-C	24-27
CORNER PROFILE 2	252-257	SALOBRENA-M	76
CRESPILO	208	SALOBRENA-RGBW	88
FERREROS	214-215	SALUZZO	158,216
FIOBBO	152-153	SARSINA	80-83
FLEXIBLE STRIPE	224-225	SARSINA-A	46-47
FUEVA 1	198-205	SARSINA-C	22-23
FUEVA 5	122-139,141-147,177-196	SARTIANO	98
FUEVA-A	51	SAVATARILA	58
FUEVA-C	28-36	STRIPE-C	38
GRIMASOLA	218-219	SURFACE PROFILE 1	236-238
LED STRIPES-DECO	231	SURFACE PROFILE 2	239-241
LED STRIPES-FLEX	226-228	SURFACE PROFILE 3	242-244
LED-STRIFE-A	52	SURFACE PROFILE 4	258-259
LOKE 1	220-221	SURFACE PROFILE 5	266
PENETO	162-166	SURFACE PROFILE 6	270-271
PIDIO	230	TEDO	168-170,173
PINEDA	94-97,100-101,112-114	TEDO 1	170,172-173
PINEDA 1	116-117	TURCONA	68-71
POLASSO	210-213	TURCONA-C	18,20-21
RECESSED PROFILE 1	260-262	ZARATE	118
RECESSED PROFILE 2	263-265		
RECESSED PROFILE 3	268-269		
RONZANO 1	150		
SALABATE	110-111		
SALICETO	102-109		







All previous catalogues and price lists are no longer valid with the issue of this catalogue. Errors, misprints, model and price changes and technical modifications are reserved. We deliver based on our terms of delivery and payment. Our products comply with the European light norm EN60598. Products with the ENEC test mark are conforming to the guide line 2006/95/EG. Products with additional safety remarks (e.g protection class, IP) are identified within the product family with the relevant symbol and number. The content of this catalogue is protected under copyright law for EGLO Leuchten GmbH. All rights reserved. Our specific written consent must be obtained before using any illustrations and texts. The pictures are 4C prints and may differ from the original.

The product pictures and ambiances in this catalogue can deviate from reality, and they do not necessarily concur with the usual application of the product. EGLO does not assume liability for the correctness, completeness or the application depiction of the products and/or the product information.

Design, layout and composition: EGLO GmbH, A-6136 Pill - AUSTRIA  
Print: Samson Druck GmbH, 5581 St. Margarethen - AUSTRIA  
Pictures: EGLO, Adobe Stock, istockphoto.com

---

Mit diesem Katalog verlieren alle vorhergehenden Kataloge und Preislisten ihre Gültigkeit. Irrtümer, Druckfehler, Modell- und Preisänderungen sowie technische Änderungen vorbehalten. Wir liefern zu unseren Liefer- und Zahlungsbedingungen. Unsere Produkte entsprechen der europäischen Leuchtnorm EN 60598. Produkte mit dem ENEC Prüfzeichen sind konform mit der Richtlinie 2006/95/EG. Produkte mit weiteren Sicherheitshinweisen (zB. Schutzklasse, IP) sind mit Symbol und Zahl bei der Produktfamilie ausgezeichnet. Der Inhalt dieses Kataloges ist für die EGLO Leuchten GmbH urheberrechtlich geschützt. Alle Rechte sind vorbehalten. Bilder und Texte dürfen nicht ohne vorherige ausdrückliche, schriftliche Genehmigung verwendet werden. Die Abbildungen sind 4C Drucke und können vom Original abweichen.

Die Katalogbilder und die gezeigten Darstellungen der Produkte können von der Wirklichkeit abweichen und nicht den üblichen Produktanwendungen entsprechen. EGLO übernimmt keine Haftung für die Richtigkeit, Vollständigkeit und Anwendungsdarstellung der Produkte und Produktinformationen.

Gestaltung, Layout und Satz: EGLO GmbH, A-6136 Pill - AUSTRIA  
Druck: Samson Druck GmbH, 5581 St. Margarethen - AUSTRIA  
Bilder: EGLO, Adobe Stock, istockphoto.com

---

Le présent catalogue remplace tous les catalogues et tarifs précédents. Sous réserve d'erreurs, de fautes d'impression, de modification des modèles et de changement de prix et de technique. Nous livrons sur la base de nos conditions de livraison et de paiement. Nos produits sont conformes aux normes européennes EN 60598 et portent le marquage CE. Les produits portant la marque ENEC sont conformes à la Directive 2006/95/EG. Les produits portant d'autres indications de sécurité (par exemple classe de protection, IP) sont identifiés par le symbole et le nombre correspondants dans la famille de produits.

Le contenu du présent catalogue est protégé pour la société EGLO Leuchten GmbH par un copyright. Tous droits réservés. Toute reproduction d'images et du texte est interdite sans autorisation explicite par écrit préalable. Les images sont imprimées en 4C et peuvent différer de l'original.

Les images des produits et les ambiances dans le catalogue peuvent dévier de la réalité et ne sont pas nécessairement en ligne avec l'usage habituel du produit. EGLO n'engage pas sa responsabilité sur la justesse des images et sur les informations relatives à l'usage pouvant être fait des produits.

Conception, maquette et composition: EGLO GmbH, A-6136 Pill - AUSTRIA  
Presse: Samson Druck GmbH, 5581 St. Margarethen - AUSTRIA  
Images: EGLO, Adobe Stock, istockphoto.com

06-2020





**EGLO**  
my light | my style

EGLO Leuchten GmbH  
Heiligkreuz 22  
A-6136 Pill  
Austria  
Tel. +43 (0) 5242 6996  
Fax +43 (0) 5242 6996-972  
info@eglo.com  
www.eglo.com

KATTLIS20

my light | my style